

# The Wireless World

AND  
RADIO REVIEW  
(14<sup>th</sup> Year of Publication)

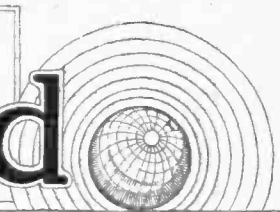
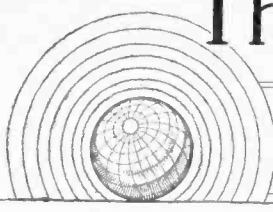

No. 375.

WEDNESDAY, NOVEMBER 3RD, 1926.

VOL. XIX. NO. 18.

Assistant Editor:  
F. H. HAYNES.

Editor:  
HUGH S. POCOCK.

Assistant Editor:  
W. JAMES.

Editorial Offices: 139-40, FLEET STREET, LONDON, E.C.4

Telephone: City 4011 (3 lines).

Advertising and Publishing Offices: DORSET HOUSE, TUDOR STREET, LONDON, E.C.4

Telephone: City 2847 (13 lines).

Telegrams: "Ethaworld, Fleet, London."

COVENTRY: Hertford Street.

BIRMINGHAM: Guildhall Buildings, Navigation Street.

MANCHESTER: 199, Deansgate.

Telegrams: "Cyclist, Coventry."  
Telephone: 5210 Coventry.

Telegrams: "Autopress, Birmingham."  
Telephone: 2970 and 2971 Midland.

Telegrams: "Hiffe, Manchester."  
Telephone: 8970 and 8971 City.

Subscription Rates: Home, 17s. 4d.; Canada, 17s. 4d.; other countries abroad, 19s. 6d. per annum.

*As many of the circuits and apparatus described in these pages are covered by patents, readers are advised, before making use of them, to satisfy themselves that they would not be infringing patents.*

## THE NEW BROADCASTING AUTHORITY.

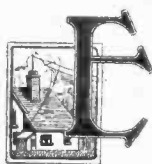

EVERYWHERE surprise is being expressed at the Government's choice of persons to constitute the original Board of the new Broadcasting Corporation.

We think that in giving us the names of the proposed

new Governors we have been told only half the story, because it is quite impossible to judge of the suitability of these persons until the Government defines to what extent the new body is to control the destinies of the B.B.C. There is no doubt that much of the criticism of these proposed appointments has been prompted by reason of the fact that, unless the intention of the Government is that this body shall be little more than a figurehead, to be advised on every point by special committees, it is difficult to understand why persons so apparently ill-suited for the task should be selected for these posts. There was a time when it was suggested that the new Board would constitute their own Programme Committee, but it appears to us that such an idea has definitely been abandoned, since no one

of the proposed new Governors seems in any way fitted by experience to gauge the requirements of the public in the matter of programmes. Nor, with the exception of Lord Gainford, is there any member who has had any practical experience of broadcasting.

It would seem to us, therefore, that the Government has arrived at the conclusion that the present organisation of the B.B.C. is best fitted to carry on its duties as

at present and that all that is required is to substitute for the Board of Directors, at present composed of members of the Wireless Trade, a new authority which will interfere even less perhaps than the present Board with the policy and activities as directed by Mr. Reith.

Throughout the text of the Broadcasting Committee's

Report frequent expression was given to the feeling of confidence of the members of the Committee in the general working and administration of the Broadcasting organisation in the past, but even prior to the sitting of the Committee it was a foregone conclusion that the Board of Directors composed of Trade members could not continue as the controlling body, but that instead some Government-appointed authority would be required to take the reins, since broadcasting had become so national in character.

We think that the decision of the Government may be regarded as a distinct compliment paid to the present B.B.C. organisation. The appointment of Lord Gainford as Vice-Chairman of the Government Board after his experience as Chairman of the B.B.C. since its inception can only be taken as an assurance of confidence both in him and in the

organisation which has been built up under his Chairmanship.

We may therefore conclude that the decision is to leave well alone and merely substitute for a Board of Trade Directors a new body with no commercial commitments in respect either of the Wireless Industry or the various other industries which are directly or indirectly associated with broadcasting.

### CONTENTS.

	PAGE
EDITORIAL VIEWS	589
EVERYMAN'S THREE VALVE SET	590
By W. James.	
SEEN AT THE BERLIN SHOW	597
HINTS AND TIPS FOR NEW READERS	599
CURRENT TOPICS	601
MANCHESTER SHOW REPORT	605
THERMIONIC AERIAL AMMETER	611
THE WIRELESS BEAM	613
BROADCAST BREVITIES	618
TRANSMITTERS' NOTES AND QUERIES	620
NEWS FROM THE CLUBS	621
READERS' PROBLEMS	622

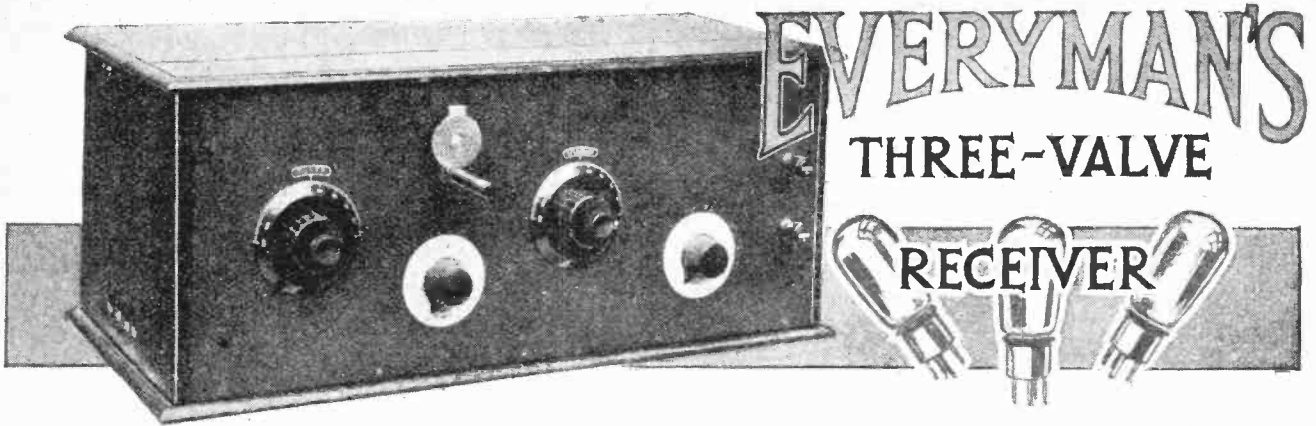

## How to Construct a Set giving Purity of Reproduction and Loud-speaker Reception of Many Stations.

By W. JAMES.

**T**HERE are many ways of connecting the valves of a three-valve receiver. We may connect them, for instance, as a detector and two low-frequency magnifiers, or as two high-frequency magnifiers and a detector. The characteristics of these two receivers are totally different. The first, with its detector and two low-frequency stages, will receive the local station at good strength and can be made easy to tune, but its selectivity will be poor. In the hands of the ordinary user it will be a good "local station" set; this in spite of the fact that when fitted with reaction its theoretical range is practically unlimited. The second receiver, with its two high-frequency stages, will be selective and extremely sensitive to weak signals, but these will never be heard at anything above telephone strength.

### MAIN FEATURES.

Three valves, comprising high-frequency, detector and power stages. Two-knob tuning, with volume and selectivity controls. Wavelength range, 200-550 metres.

Magnification, H.F. 200, L.F. 850; practically uniform from 100-5000 cycles.

Such a set when used with an appropriate aerial would receive most European stations, but would demand a fair amount of operating skill.

A general purpose receiver is obtained by a combination of these two, using one stage of high-frequency magnification for selectivity and range and a power output stage for quality and volume. We then have a receiver with which it is fairly easy to tune in several broadcast stations at loud-speaker strength and many stations at comfortable head telephone strength;

to do this it is necessary to design very carefully if good quality is to be had.

Selectivity and, to a large extent, sensitivity is governed principally by the high-frequency circuits. To be selective a circuit must be of low resistance, or, alternatively, a number of filter circuits will have to be used. With two tuned circuits the necessary selectivity can be obtained by the use of single layer coils 3in. in diameter wound with Litzenbraht conductor having 27 strands of No. 42 S.S.C. wire. But great care has to be taken when connecting these coils in circuit that their apparent resistance is not considerably increased, for this would immediately reduce the selectivity. It is for this reason that low loss coils are connected in such a way that they are not shunted by relatively low resistances.

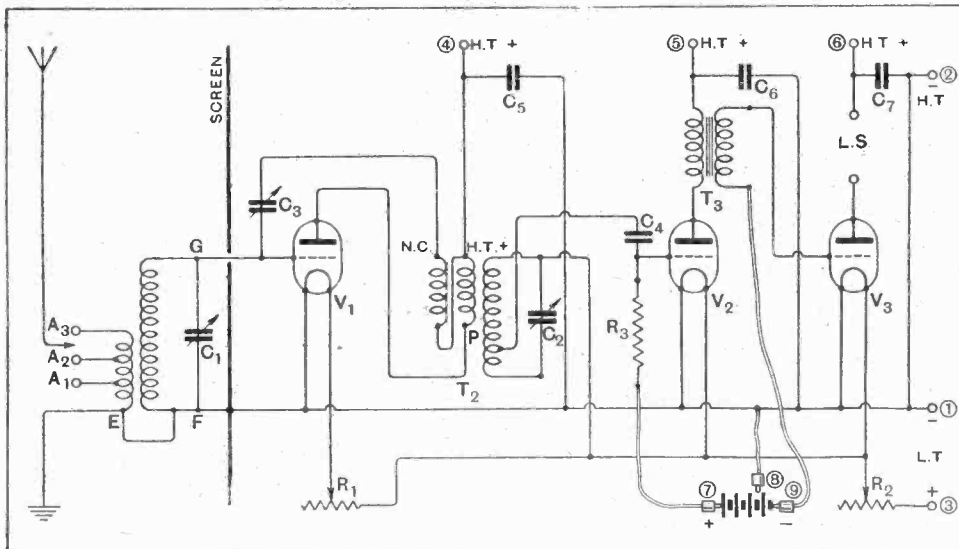

Fig. 1.—Theoretical connections: EGF, aerial-grid transformer;  $T_2$ , intervalve H.F. transformer;  $C_1$  and  $C_2$ , 0.0003 mfd. tuning condensers;  $C_3$ , stabilising condenser;  $C_4$ , 0.0002 mfd. grid condenser;  $C_5$  and  $C_6$ , 1 mfd. condensers;  $C_7$ , 2 mfd. condenser;  $V_1$ , high impedance high frequency amplifying valve;  $V_2$ , high impedance detector valve;  $V_3$ , low impedance output valve;  $R_1$ , 30 ohms volume control;  $R_2$ , 7 ohms filament rheostat;  $R_3$ , 2 megohms grid leak.

In the case of the

**Everyman's Three-valve Receiver.**—

aerial circuit the aerial is connected to a point on the coil instead of to the end, the amount of the coil included between the aerial and earth being dependent on the selectivity and signal strength required. This, in turn, is affected by the electrical properties of the aerial; for a given coil and a definite degree of selectivity the aerial connection will have to be made at a point on the coil depending on the aerial. A high resistance aerial would be connected to include more of the coil than a low resistance one, and the selectivity would be improved by reducing the amount of the coil included in the aerial circuit.

At the same time the signal strength is varied by altering the position of the aerial tapping. If the aerial and earth are connected to the ends of the coil a voltage of, say, one unit is obtained across the tuned coil; as the aerial tapping is lowered towards the earthed end the voltage increases until it reaches the maximum of, perhaps, two or three units. A further reduction in the number of turns included in the aerial circuit results in a falling off in the signal strength.

With a low loss coil such as the one used in the set illustrated here the voltage set up across the ends of the coil by a signal received from the local station. (2I.O)

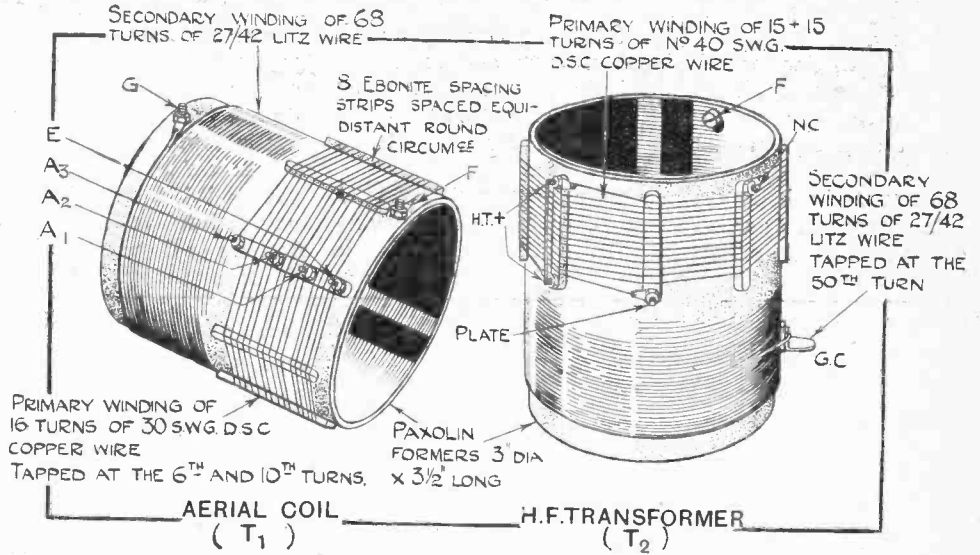
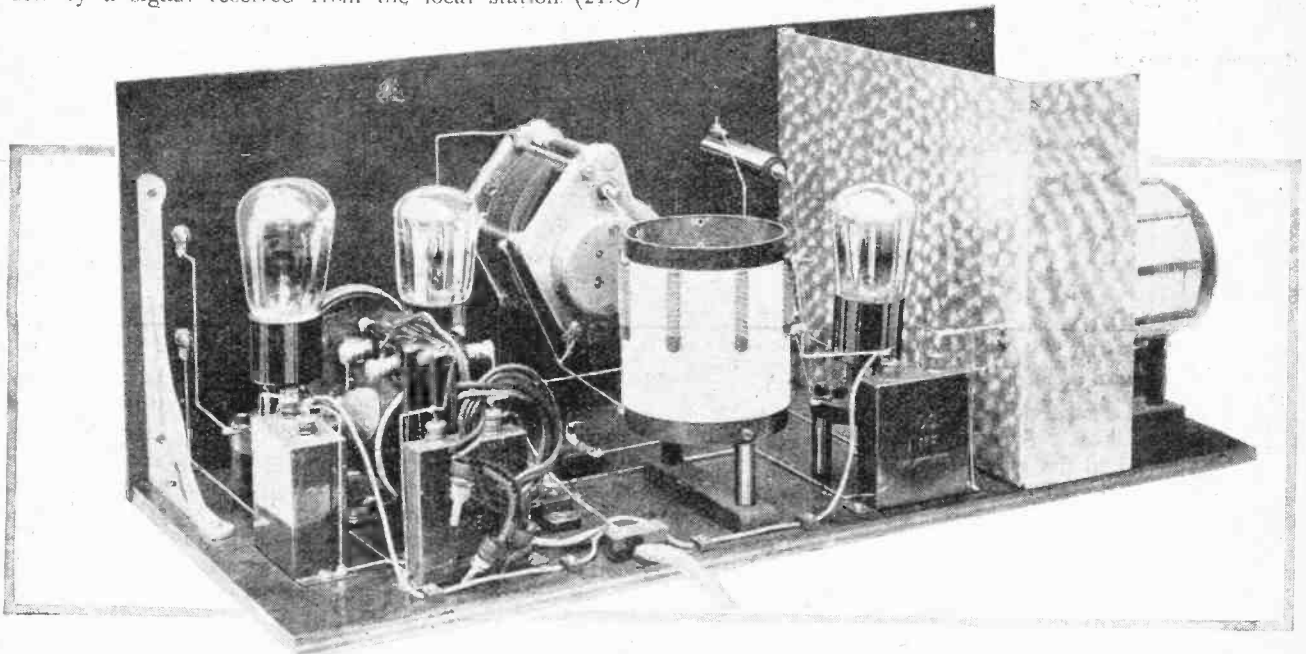

Fig. 2.—Windings of aerial-grid and high-frequency intervalve transformers.

was increased over three times by removing the aerial from the end of the coil and connecting it to the optimum point on the coil. At the same time the selectivity was greatly improved.

**Selective H.F. Transformers.**

To gain further selectivity the aerial can be moved towards the earthed end, but only at the expense of signal strength. In many instances the maximum signal strength is not required; it is more important to secure even better selectivity. This is easily arranged for by



View of the set, without its cabinet, from the output end. No terminal strip is used, but a battery cable is connected to the circuit, the wires being held by cleats.





**Everyman's Three-valve Receiver.—**

the detector across the ends of the secondary coil of  $T_2$ , which is of low loss construction, for in the first place to connect such a load across the coil would lower the voltage across the ends of the coil, and, secondly, the

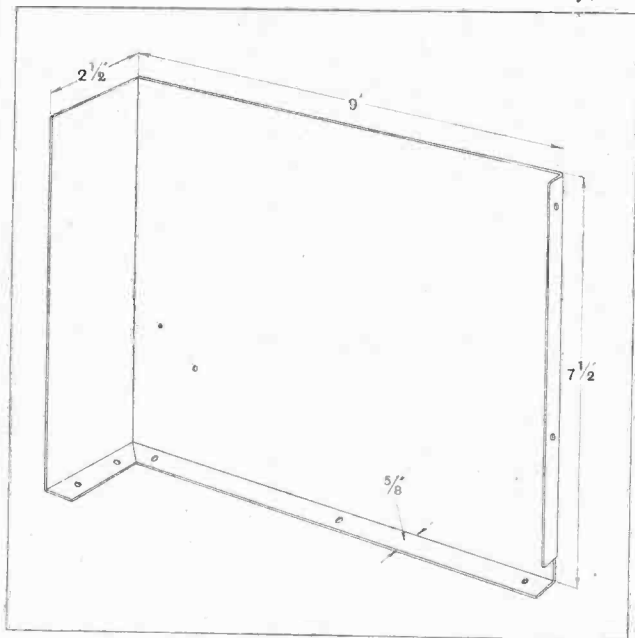

Fig. 4.—The aluminum or copper screen. Notice the two holes for connecting wires. One is for the grid, and the other for an earth wire.

selectivity would be impaired. In other words, if the transformer were designed to suit valve  $V_1$  and to get the maximum voltage developed across the condenser terminals, the effect of connecting the rectifier would be to lower the voltage across the condenser terminals and reduce the selectivity of the transformer. The effect of the detector can, of course, be allowed for when designing the transformer, but it is necessary to consider carefully the relative importance of amplification and signal strength. With only one high-frequency stage available best all round results are usually obtained by connecting the grid of the rectifier to a point on the coil as indicated in the diagram. The effect of this connection is a gain in selectivity, the selectivity being nearly as good as when an anode bend rectifier connected across the whole of the coil is used, while owing to the greater sensitivity of the grid circuit, as compared with an anode bend rectifier, a weak applied signal will

give a greater response in the output circuit. Apart from a tap on the secondary winding this transformer is identical in construction with those used in other receivers described by the writer, and a full description of their design was given when describing "Everyman's Four-valve Receiver."<sup>1</sup>

In the anode circuit of the detector is a transformer  $T_3$  having a ratio of 3.5 to 1. The instrument recommended is a Ferranti type AF3, and it has a 0.0003 mfd. condenser connected across its primary by the makers. A condenser of approximately this capacity should always be used in the anode circuit of a rectifier, so that if a different type of transformer is used a condenser of this value will have to be provided.

**Special Detector Connections.**

The writer intended to obtain the maximum output from the rectifier consistent with selectivity and good quality. From the point of view of selectivity only, an anode bend rectifier could have been used and a resistance coupling employed to preserve the quality, but such an arrangement does not give much amplification. An anode rectifier has an A.C. resistance of anything over 100,000 ohms provided the valve is of a type having an amplification factor of, say, 12 or more, so that a transformer coupling is out of the question; but there are valves available having an amplification factor of 25 to 35 whose A.C. resistance can be forced down to 30,000 ohms by employing them as a grid circuit rectifier with a high anode voltage. For instance, the A.C. resistance of a "Cosmos" SP55 Blue Spot valve with an anode voltage of 120 and the grid connected to negative low tension is 50,000 ohms and its amplification factor is 35. By connecting this valve as a grid

<sup>1</sup> *Wireless World* of July 28th and August 4th, 1926.

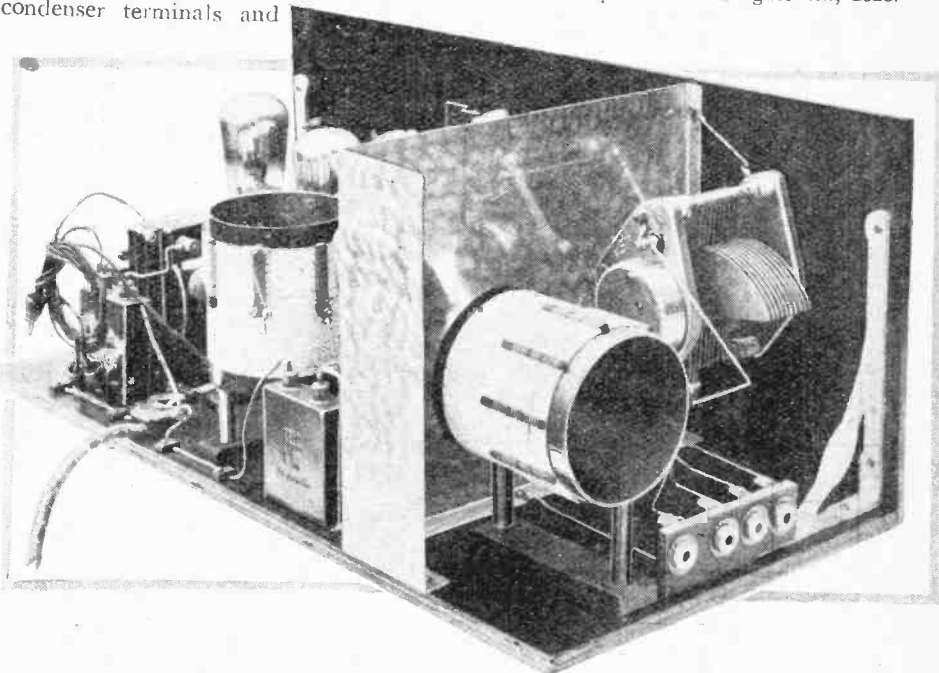

The aerial-grid coil connection strip, tuning condenser and screen. This end is electrostatically shielded from the remainder of the set.

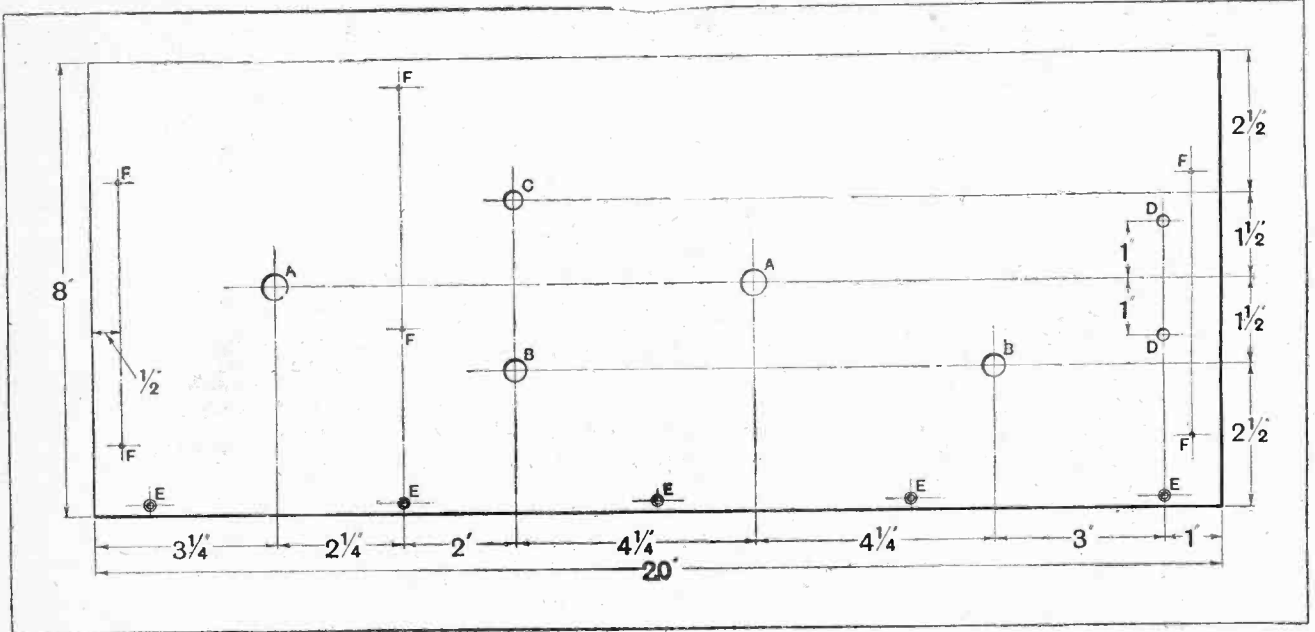

Fig. 5.—Ebonite front panel: A, 15/32"; B, 13/32"; C, 11/32"; D, 7/32"; E, 1/4" diameter, and countersunk for No. 4 wood screws; F, tapped 6BA from back of panel for brackets.

circuit rectifier its A.C. resistance is brought down to 30,000 ohms. A Ferranti AF<sub>3</sub> transformer, with its primary rated at 80 henries, can be connected to a valve of this impedance and will give practically perfect amplification over the whole range of musical frequencies. The amplification obtained is  $35 \times 3.5$  or, roughly, 120. This is a high amplification, and thus the receiver is sufficiently powerful to give loud-speaker reception of

several distant stations with good quality. There are one or two other points of interest. The first is the volume control  $R_1$ . This takes the form of a filament rheostat connected to the high-frequency amplifying valve. As the filament of this valve is dimmed by increasing the resistance of  $R_1$ , the A.C. resistance of the valve is raised. This lowers the amplification.

The second is the grid leak connection. One end of

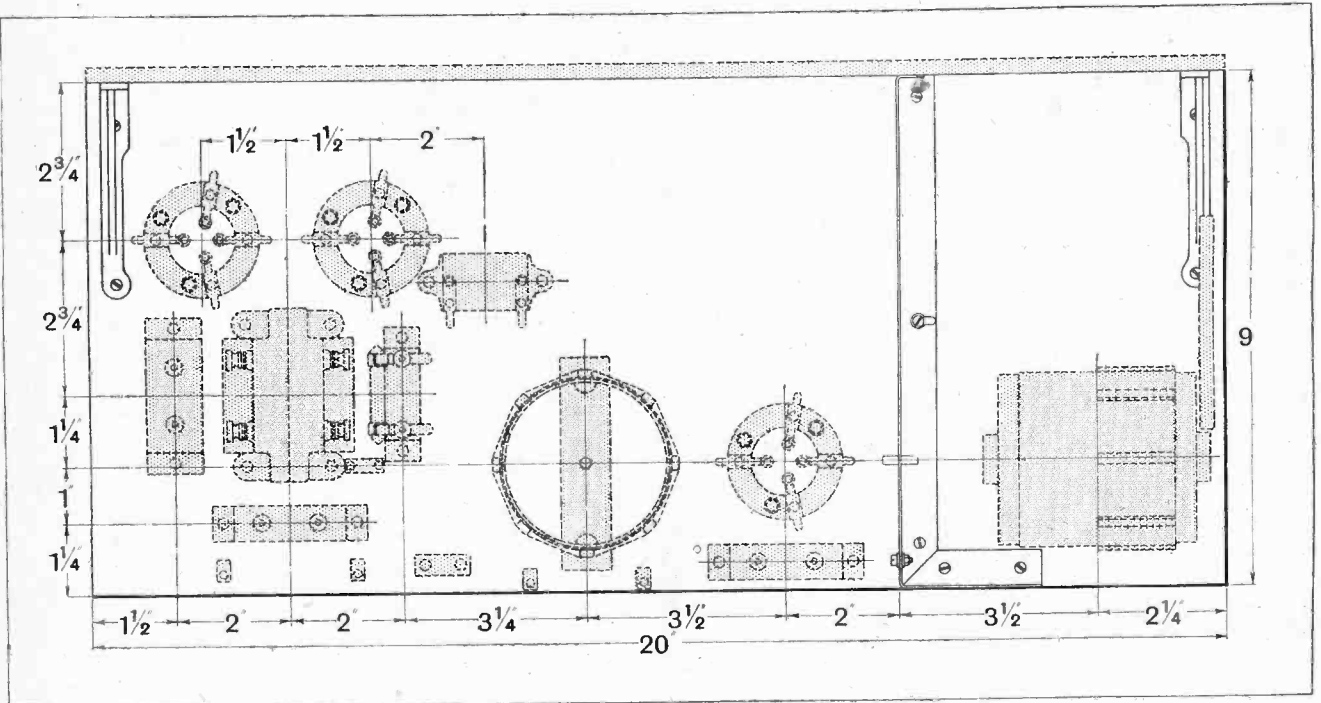
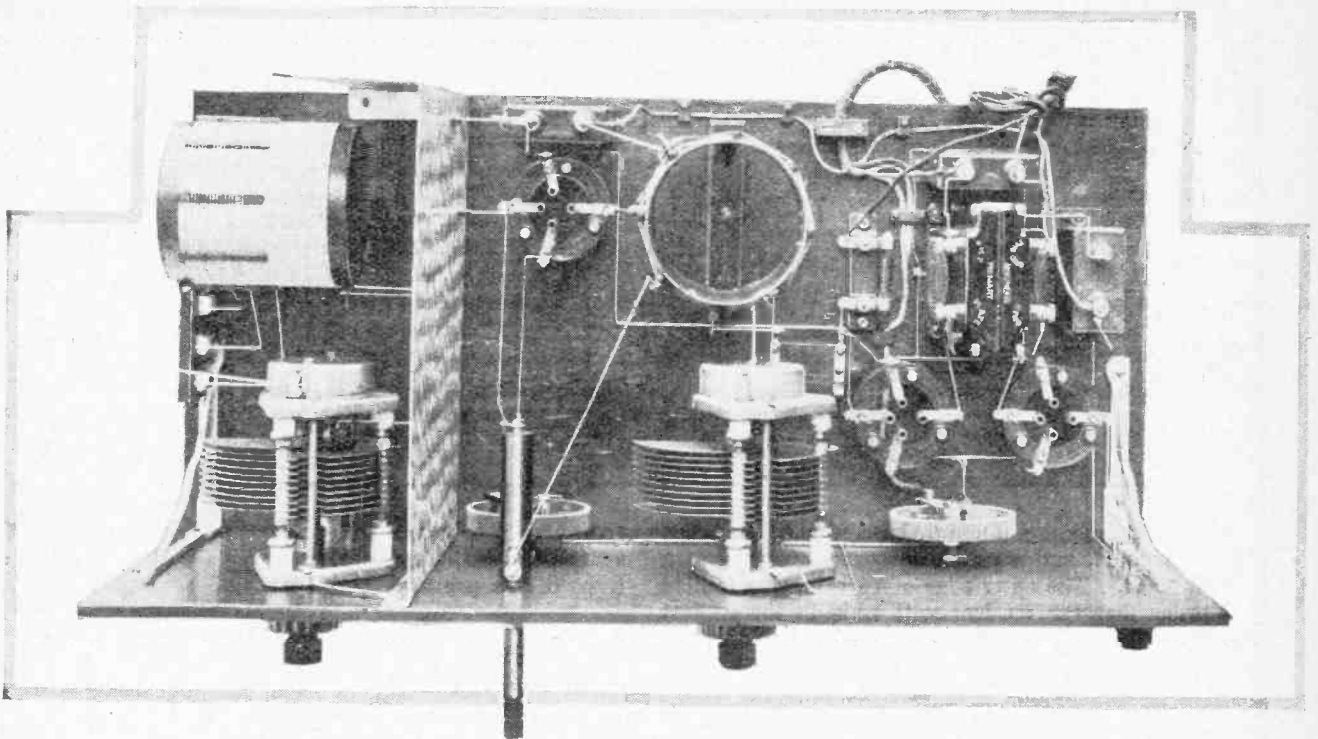

Fig. 6.—Arrangement of parts on the baseboard.



Plan view of the set showing all the components. There is plenty of room at the H.F. end.

the grid leak  $R_3$  is connected to the grid of  $V_2$  and the other to a wander plug (7). This plug is connected to the grid bias battery, and the mean grid potential can be varied within certain limits. For a given valve it will be found possible to make an adjustment which results in the greatest sensitivity.

Thirdly, a metal screen is placed between the aerial-grid circuit and the tuned intervalve transformer. This is to minimise electrostatic couplings. Without the screen it is not possible to effect a perfect balance of the H.F. valve, which is satisfactory over the whole tuning range of the transformers.

Fourthly, the usual terminal strip for battery connections is not used, but a cable having six wires is employed. The filament wires are thicker than the H.T. wires, and each wire has a different colour and is provided with coloured connecting spade ends. The wires are numbered 1 to 6; wires 7, 8 and 9 are ordinary flexible wires fitted with wander-plugs for connecting with the grid bias battery.

There is nothing unusual in the construction of the set; in fact, it is quite an easy one to build. An ebonite front panel is used to carry the two tuning condensers, the balancing condenser, the two filament rheostats, and two loud-speaker terminals. These parts are arranged as indicated in Fig. 5. A base-

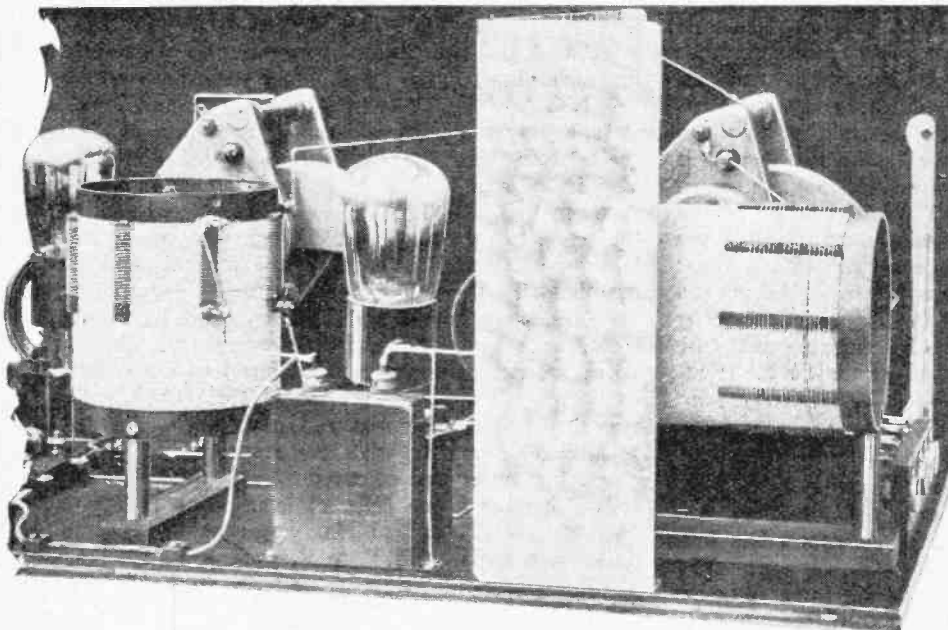

(Left) H.F. intervalve transformer, H.F. and detector valves. (Right) Aerial-grid coil and terminal strip. The construction of the two transformers is clearly shown.

## LIST OF PARTS.

- |   |   |
|---|---|
| <p>1 Ebonite panel, 20in. × 8in. × ¼in. (British Ebonite Co.).<br/>         1 Baseboard, 20in. × 9in. × ¼in.<br/>         1 Cabinet, "Cameo" (Carrington Manufacturing Co.).<br/>         1 Pair cast aluminium brackets (Carrington Manufacturing Co.).<br/>         2 0-0003 mfd. tuning condensers (W. G. Pye &amp; Co.).<br/>         2 Dial indicators (Belling &amp; Lee).<br/>         1 Balancing condenser with dial (Gambrell).<br/>         1 0-0002 mfd. fixed condenser (Dubilier).<br/>         1 2 megohms grid leak with holder (Dubilier).<br/>         2 1 mfd. condensers (Telegraph Condenser Co.).<br/>         1 2 mfd. condensers (Telegraph Condenser Co.).</p> | <p>3 Valve-holders (Bowyer-Lowe).<br/>         1 Low-frequency Transformer (Ferranti AF3).<br/>         1 Reel of Lilzen wire, 27-42, double silk covered (Ormiston &amp; Son).<br/>         2 Paxolin tubes, 3in. diameter by 3½in. long (Micanite &amp; Insulators, Ltd.).<br/>         4 Sockets and 2 plugs (Lampugh).<br/>         1 Filament rheostat, 30 ohms. (Burndept Wireless, Ltd.).<br/>         1 Filament rheostat, 7 ohms. (Burndept Wireless, Ltd.).<br/>         2 Ebonite shrouded terminals (Belling &amp; Lee).<br/>         1 Six-way battery lead (London Electric Wire Co.).<br/>         2 9-volt grid bias batteries, and three wander plugs.</p> |
|---|---|

NOTE.—Readers who prefer to buy the aerial-grid and H.F. intervalve transformers instead of constructing their own are referred to the advertisement columns.

Approximate Cost of Complete Set of Parts - £9 : 0 : 0.

board of wood, 20in. × 9in. × ½in., is screwed to the lower edge of the panel, and a pair of brackets are used as a further support. The outer edge of each bracket is filed flat in order that the receiver will slide in the cabinet without fouling.

On the baseboard is mounted the fixed condenser, grid leak, and valve-holders; the valve-holders are raised about 1½in. by ebonite rods (B, Fig. 3), although a support of wood would do equally well. At one end is the aerial and earth connection strip; this is made of ebonite (E, Fig. 3), and has four sockets. A portion is filed away as indicated in the sketch to clear the bracket. This strip is clearly shown in the illustration on page 593.

The next item to be made is the screen, which can be of aluminium or copper sheet. It is sketched in Fig. 4. This is screwed to the baseboard and to the panel as indicated. Finally, the aerial grid and intervalve high-frequency transformers have to be constructed. These transformers have secondary windings of 68 turns of Litzendraht conductor, having 27 strands of No. 42 S.S.C. wire with a D.S.C. over all, and the former is of Paxolin tube, 3in. in diameter by 3½in. long, as shown in Fig. 2. The ends are soldered to tags held by screws and nuts. To clean the ends untwist about 1½in. of the Litzendraht and remove the silk covering with a blunt knife or a piece of very fine glass paper. Each strand should be cleaned; then they can be twisted together and soldered. The tap is made by cleaning the wire and soldering it to a small tag, as illustrated in the right-hand sketch, Fig. 2.

#### Construction of Transformers.

The primary windings are wound over and at one end of the secondary coil and are spaced by pieces of ebonite; for the aerial coil 8 ebonite spacers 1½in. long by ¼in. wide by ¼in. thick are required, and one spacer has four small screws fitted, as in drawing G, Fig. 3. The primary winding, which is wound in the same direction as the secondary and not in the opposite direction, as accidentally shown in the sketch of the aerial coil of Fig. 2, has 16 turns of No. 30 D.S.C., with taps at the

sixth and tenth turns. It is advisable to hold the ebonite spacers in position with rubber bands until the first few turns of the primary are in position.

#### Wiring of Battery Cable.

The H.F. transformer has a double winding of No. 40 D.S.C., the turns in each winding being spaced. Eight spaces are required, and three of them have small screws fitted, as shown at F Fig. 3, and the sketch of Fig. 2. Hold the spacers in position with rubber bands as before, and start winding the primary coil from connection "+ H.T." (opposite the end of the secondary). This winding is wound in the same direction as the secondary, and has 15 turns spaced about 15 to the inch. Finish this coil at the tag marked "plate."

The second fine wire winding is connected at the screw marked "NC," and the wire is wound in the space between the turns of the first winding; it is terminated at the tag marked "+ H.T." Do not forget to connect the two + H.T. tags. Having wound the coils, fit them to their bases, that for the aerial coil being sketched at C, Fig. 3, and for the H.F. transformer at D, Fig. 3.

When the transformers have been fixed in position the set is ready for wiring. A coloured wiring diagram is provided with this issue of the journal, and if it is examined it will be found that wiring is a simple matter. It is necessary to secure the battery cable by means of a cleat, as shown in the illustrations; then the various wires are cut to length and soldered to the components as shown. The London Electric Wire Co.'s cable has two thick wires, coloured red and black, for filament positive (3) and negative (1) respectively. The four remaining wires are coloured black, white, green, and red. The black one (No. 2) is negative H.T.; No. 4 (white), + H.T. to  $V_1$ ; No. 5 (green), + H.T. to  $V_2$ ; and No. 6 (red), + H.T. to  $V_3$ .

Finally, fix the grid bias batteries to the back of the cabinet and the three flexible wires with wander plugs.

(To be concluded.)

#### WIRING DIAGRAM.

A wiring diagram supplement is included with each copy of this issue.

# SEEN AT THE BERLIN SHOW

Multiple Valve Units—Quartz  
Wavemeters—A New Loud-  
speaker.

UNDOUBTEDLY the most striking series of exhibits at the German Wireless Exhibition, held in Berlin from September 3rd to 12th, was the range of multiple valves exhibited by the Løwe-Radio Company. This firm made the startling announcement that in future they proposed to discontinue the manufacture of ordinary three- and four-electrode receiving valves, and to concentrate on multiple-valve units incorporating resistance-capacity coupling. The firm have been working in close collaboration with Messrs. von Ardenne and Heinert, and have for some considerable time been producing amplifiers of this type completely enclosed in a glass bulb.<sup>1</sup>

In future two types are to be manufactured—Type 3NF, a three-valve detector and low-frequency

<sup>1</sup> *The Wireless World*, December 16th, 1925, page 857.

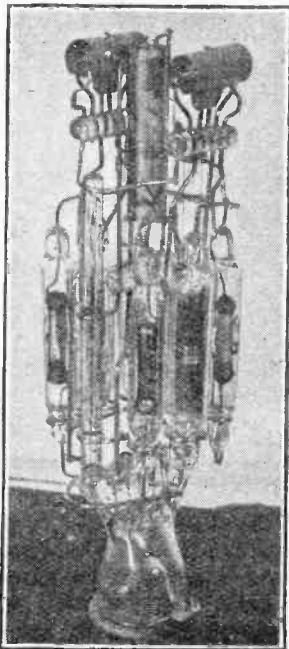

3NF.

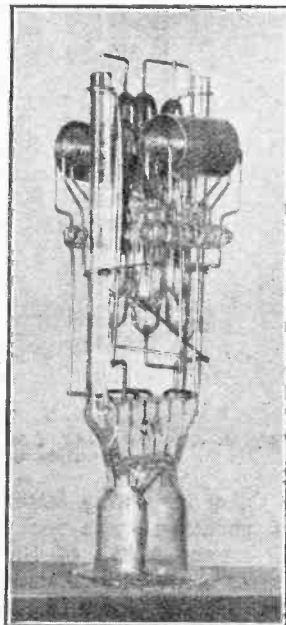

2HF.

Fig. 1.—Interior construction of multiple valves by Løwe-Radio Company of Berlin.

A 29



amplifier unit, and Type 2HF, a two-valve high-frequency amplifier. The well-known Løwe resistance elements will be used throughout. These resistances have a high reputation for consistency—a highly important property in view of the fact that the component parts will be sealed up, thus making replacements difficult. Incidentally, we are informed that in the event of a filament burning out, the makers are prepared to replace this at a cost of only 8s.

In the 3NF unit two of the valve elements are of the 1A77 type, which have hitherto been marketed as separate valves for resistance-capacity coupling. The third valve is specially designed to supply power to the loud-speaker, and the electrodes are mounted vertically, as seen in Fig. 2. The filament current is 0.3 amp. at 4 volts, and the normal anode potential is 90 volts. For good loud-speaker volume, however, an anode voltage of 150 is recommended. The price of this valve, together with a special six contact base, is approximately 17s. 6d. plus a licence fee of 7s. 9d.

In the two-valve H.F. unit four-electrode valve elements are employed, and the resistances and coupling condensers are mounted in closer proximity to the valves, as seen in the left-hand photograph in Fig. 1. With this unit it has been found possible to obtain appreciable amplification on wavelengths down to 200 metres. Selectivity, of course, is not a feature of this type of circuit, but it has been found practicable to obtain sufficient selectivity for most purposes by means of a loosely coupled tuner. The filament consumes a current of 0.17 amp. at 4 volts, and the total anode current is 5 milliamps, with a H.T. voltage of only 15. The price of the unit is 15s. plus a licence fee of 5s., and the special socket costs 2s. 3d.

A complete receiver incorporating both these valve units, together with appropriate tuning and coupling circuits, was also demonstrated by the company. The circuit of this receiver is shown in Fig. 2, and the price is £6 15s. inclusive of licence fees, but exclusive of the four plug-in coils. The sensitivity of the set as a whole has been improved by the addition of a small



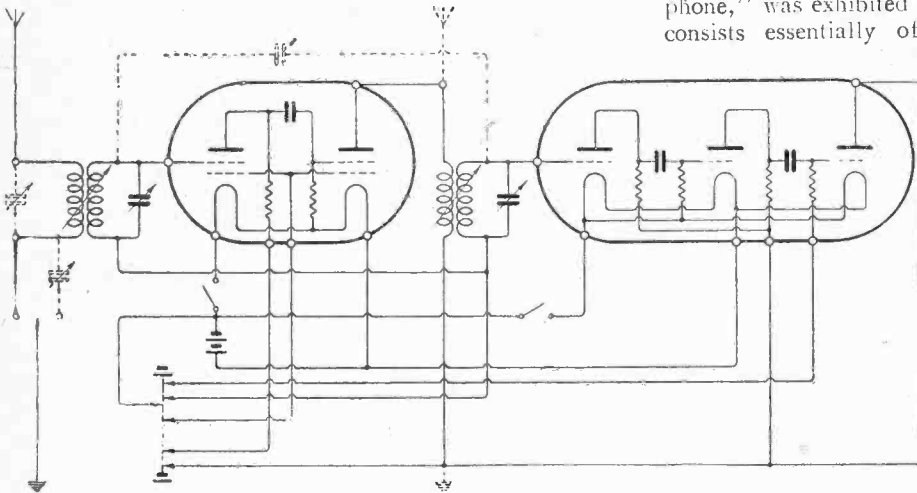

Fig. 2.—Circuit diagram of complete receiving set by the Løwe-Radio Company, incorporating their H.F. and L.F. multiple valves.

reaction condenser connected between the grid of the first H.F. valve and the detector valve grid.

Several examples of piezo-electric wavemeters were shown by the Radio Frequenz G.m.b.H., a subsidiary company of the Løwe-Radio group. These wavemeters make use of the effect discovered by Dr. Giebe and Dr. Scheibe.<sup>2</sup> The wavemeter in its commercial form has already been described in this journal.<sup>3</sup> Owing to a regulation prohibiting the use of oscillation generators in the Exhibition Hall, it was not found possible to show these wavemeters under working conditions, but private demonstrations were given at the Reichsanstalt, where the discovery was originally made by Dr. Giebe and Dr. Scheibe. An interesting discovery has been made in connection with these resonators. If a short wire connected to the grid of a valve detector amplifier is brought into close proximity with the bulb containing the resonator, a note is heard in the loud-speaker whenever the resonator glows. The note is highest at resonance, and the pitch falls off on either side of the resonance point, so that this forms a useful method of indicating exact resonance when a high degree of accuracy is required.

An interesting loud-speaker, known as the "Arco-

<sup>2</sup> *The Wireless World*, December 23rd, 1925, page 696.

<sup>3</sup> *The Wireless World*, July 14th, 1926, page 65.

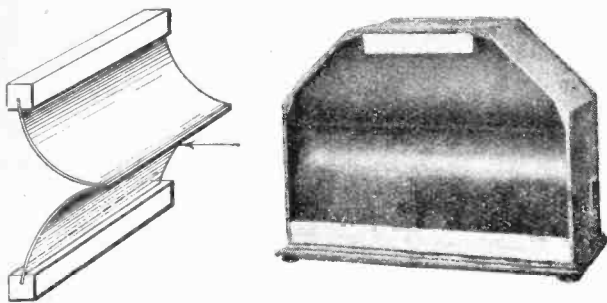

Fig. 3.—Principle of the "Arcophone" loud-speaker exhibited by Messrs. Siemens-Halske.

phone," was exhibited by Messrs. Siemens-Halske. This consists essentially of two curved soundboards of a material known as "Pertinax," secured at the outer edges and stiffly sewn together to form a ridge, as indicated in Fig. 3. Vibrations are imparted to the soundboard in the direction of the arrow.

A giant loud-speaker, known as the "Protos," and constructed on the same principle, was mounted at the top of the kiosk in the centre of the hall. In this loud-speaker speech currents are made to traverse an aluminium strip about 20 in. long running along the edge of the soundboard. This strip is situated in the gap of a powerful magnet,

and consequently moves backwards and forwards under the influence of the amplified speech currents. The quality was remarkably good, and the volume so great that some little annoyance was caused to occupants of stands in the immediate vicinity.

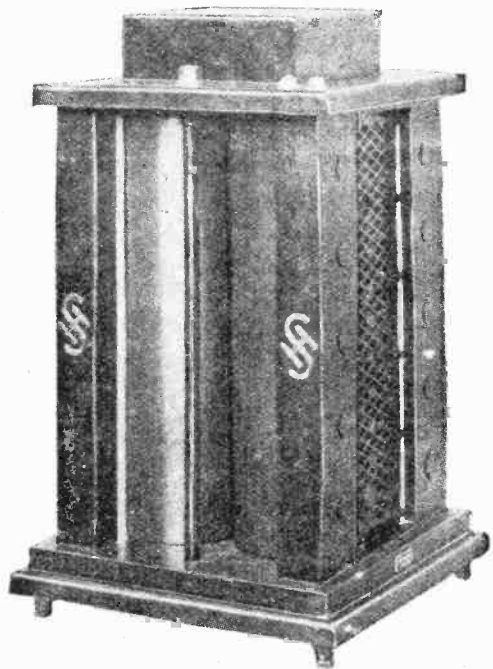

Fig. 4.—The "Protos," a loud-speaker operating on the same principle as the "Arcophone."

Other interesting features of the Show were the range of general-purpose receivers manufactured by Messrs. C. Lorenz A.-G., of Berlin, and a series of push-pull valves manufactured under the name of "Dustron" by Dr. Nickel G.m.b.H., of Charlottenburg. The valve is somewhat similar to the "Pentatron," or five-electrode valve, described on page 854 of the issue of this journal for June 23rd, 1926.



A Section Devoted to the Practical Assistance of the Beginner.

**SWITCHING A RESISTANCE-COUPLED L.F. AMPLIFIER.**

Provided that a high-amplification valve is used as a detector, with a large applied H.F. voltage across its grid circuit, a single stage of resistance-coupled L.F. amplification is sufficient for the operation of a loud-speaker. For the reception of distant stations, however, even if this combination is preceded by an efficient high-frequency amplifier, the volume obtainable will probably be insufficient, and another L.F. valve may be desirable. This may also be coupled by the resistance-capacity method

A convenient arrangement for switching this extra valve in or out of circuit is shown in Fig. 1. This method has the advantage that the anode resistances, which may very possibly be of different values, are not changed over, and that the loud-speaker remains in the anode circuit of the second L.F. valve, which will presumably be of the low-impedance type suitable for use in this position. Moreover, the anode voltages applied

to the valves are not interfered with, and different values may be used if required. If automatic control of the first L.F. filament is desired, it may easily be arranged for by substituting a three-pole switch, with the third blade connected in such a way as to break this circuit when in the "off" position.

It should be added that the insulation of the switch should be above suspicion, more particularly when the anode and grid resistances have a high value, as is generally the case when high-amplification valves are used

**PROTECTING THE VALVES.**

When the loud-speaker or telephones are connected to a long extension lead without an output transformer, there is always a slight risk of introducing a short-circuit by making contact with some earthed object, such as a gas-fitting or pipe, electric-light conduit, radiator, or even the wiring of the household bell system. If the negative side of the L.T. battery is joined internally to

the negative H.T., as is generally recommended in this journal, the result of such an accident will be a short-circuit of the H.T. battery. This may not be very serious, provided that the contact is of short duration. If, however, the negative end of the H.T. battery is connected to the positive L.T. terminal, with the idea of obtaining a few extra volts on the anodes, the result may be much more serious, as it is quite possible that the valve filaments will be burnt out.

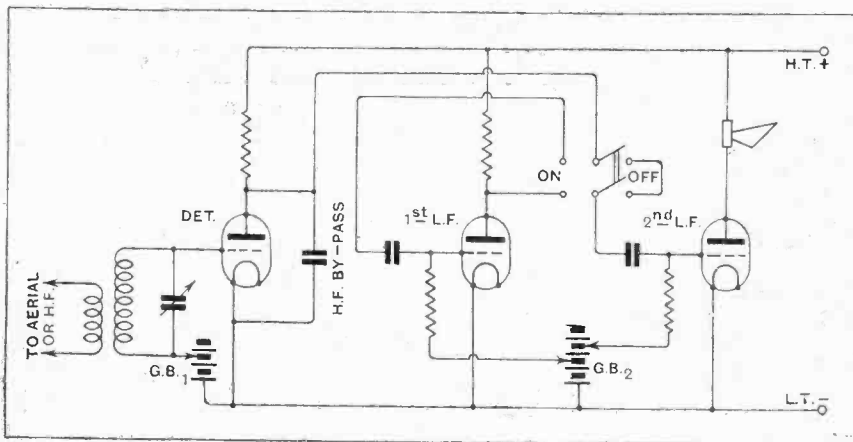

Fig. 1.—Eliminating a resistance-coupled L.F. stage.

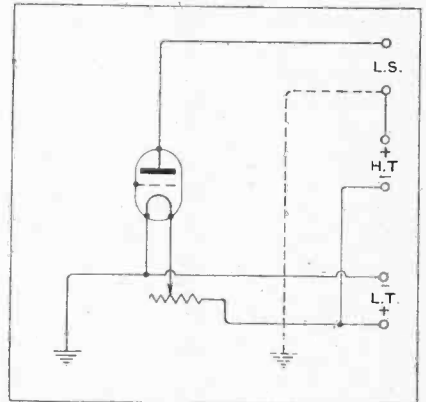

Fig. 2.—Showing the danger of connecting H.T. - to L.T. +.

A consideration of Fig. 2 will show how this may happen. It is assumed that the negative side of the L.T. battery is connected to earth; this is so in the majority of cases. If the loud-speaker or telephone lead joined to the positive H.T. terminal comes in contact with an "earth," the high tension is completed through the valve filament and the normal earth connection of the receiver.

A similar accident may result from a momentary contact between any positive H.T. lead and one of the earthed metallic screens which are included in many modern receivers.

The fact that this can only happen with the "negative to positive" connection is an additional argument in favour of the adoption of the "negative to negative" system.

**THE CARBORUNDUM DETECTOR.**

There seems to be a general impression that the carborundum detector can only be used in conjunction with a battery and potentiometer. While it is unquestionably true that this addition makes considerable increase to its sensitivity when dealing with weak signals, it should be realised that, for short-distance work, this crystal can be used without any local battery, and is capable of giving strong signals when supplied with a sufficiently great input. Reliability is one of its greatest advantages.

Carborundum has a considerably higher resistance than the ordinary specimen of treated galena, and

consequently imposes less damping on the circuit across which it is connected. It is for this reason that its substitution, even without a potentiometer, for the more generally used "ite" type of crystal may sometimes actually give louder signals, particularly when the receiver does not include an arrangement for reducing the effects of detector damping.

**SOME ACCUMULATOR HINTS.**

Beginners will soon realise the need for keeping clean the accumulator terminals which are connected to the set, but it has often been noticed that they neglect those joining together the individual cells of a battery. These terminals and connectors are equally subject to corrosion.

The under-sides of the terminals should be rubbed on a piece of glass or emery paper, which is spread on a

flat surface, then carefully wiped with a rag, and lightly smeared with vaseline. The connecting bars should be treated in a similar manner.

An accumulator battery should be recharged as soon as its voltage has fallen to 1.8 volts per cell; its life will be shortened if the all-too-common practice of working it until signals fade out is followed. Current should not be taken from a 4-volt battery after the meter reading falls to 3.6 volts. The safety limit in the case of a 6-volt battery is 5.4 volts.

Always take a voltage reading when the battery is actually supplying current to the valves. "Open circuit" measurements, made while the accumulator is not on load, are almost valueless, as full pressure will probably be indicated even if the cells are almost completely discharged.

**DISSECTED DIAGRAMS.**

Step-by-step Wiring in Theory and Practice.

No. 48a.—A Single-stage H.F. Amplifier with Anode Detector.

(To be concluded in next week's issue.)

*In this series of diagrams it is hoped to make clear the steps to be taken in converting theory into practice in the construction of various typical wireless receivers. The arrangement shown below represents good modern practice, and may be followed by an L.F. amplifier, the first stage of which should generally be resistance-coupled.*

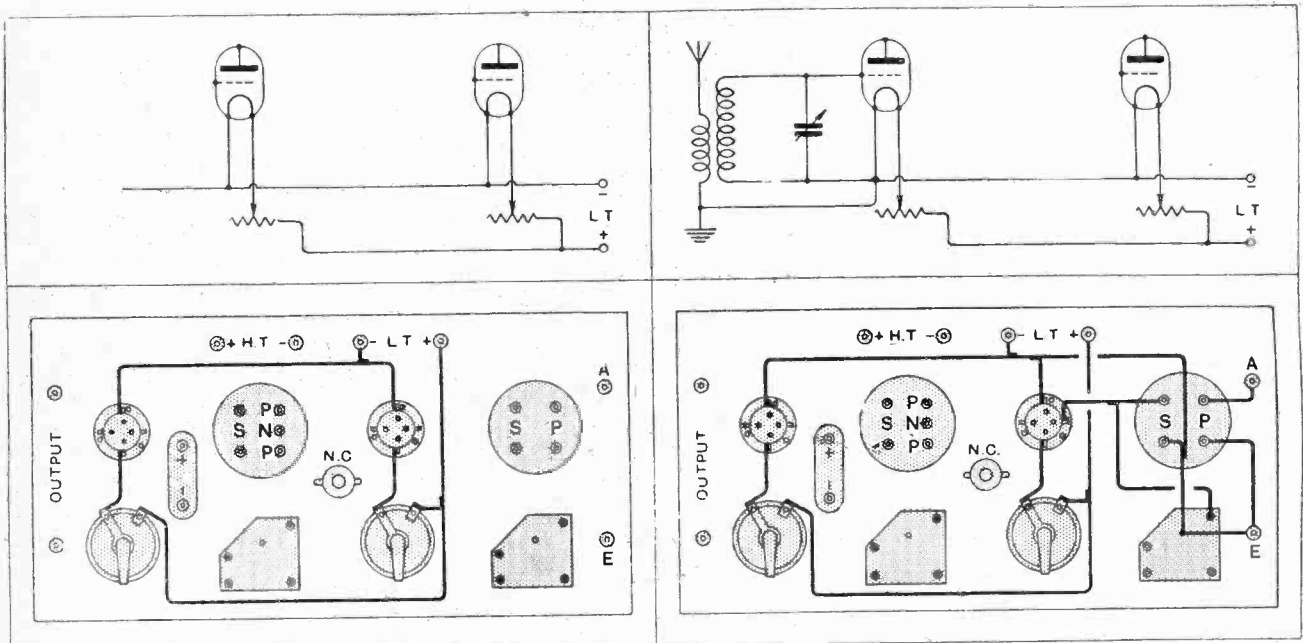

The filaments are wired in the usual manner. As the detector is to operate as an anode rectifier, separate control is likely to be of advantage, and is therefore provided.

The aerial-earthing circuit is completed through the primary of a coupling coil, the tuned secondary of which is connected between grid and filament of the H.F. valve. The L.T. battery is earthed.

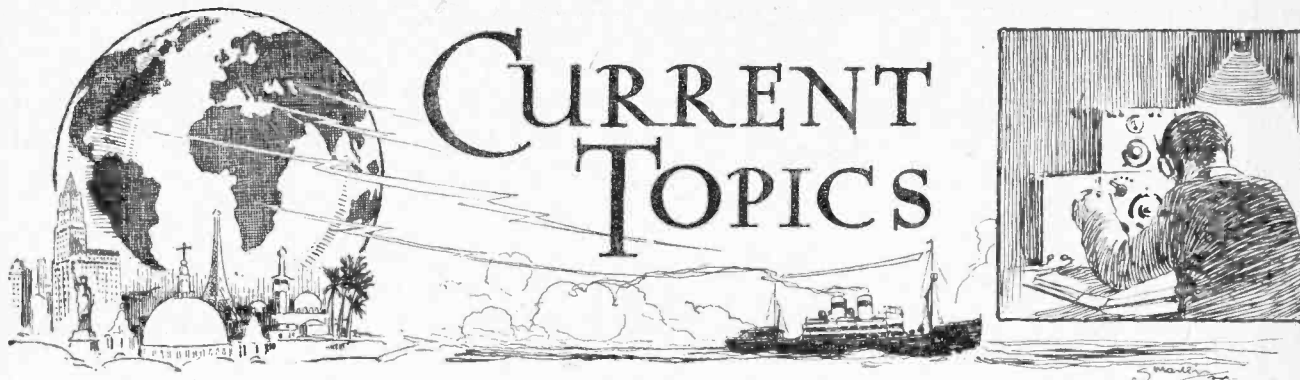

Events of the Week in Brief Review.

**HOPE DEFERRED.**

It is understood that Mars will defer communicating with the Earth until National Wireless Week.

o o o o

**THE PROPER ATMOSPHERE.**

By means of loud-speakers visitors to a Trafalgar Day bazaar at Tettenhall Wood, near Wolverhampton, were able to hear the concert broadcast from H.M.S. "Victory."

o o o o

**GOING AHEAD WITH THE BEAM.**

The Imperial beam service to South Africa will probably be opened in about a fortnight's time. The Indian service will probably begin early in December and the Australian in January.

o o o o

**ALL ROADS LEAD TO MANCHESTER.**

Manchester continues this week to be the mecca of radio enthusiasts in the north of England, on account of the *Evening Chronicle* Wireless Exhibition now being held in the City Hall. The exhibition will remain open until Saturday next, November 6th.

o o o o

**TELEPHONY TO U.S.**

There is little likelihood that a wireless telephony service to the United States will become a fact in the near future, despite recent rumours. An official of the Post Office stated last week that many technical difficulties have still to be overcome.

o o o o

**TELEVISION AND A CAUTION.**

A plea that television devices should be under Government control was made by Lt.-Col. J. R. Relf in his lecture before the Radio Society of Great Britain on Tuesday, October 26th. "What," he asked, "would be the consequences if this invention got into the hands of unscrupulous traders at home and abroad?"

The application of television, said the lecturer, meant revolution to practically all standards of living at the present time. It was a warning to all to put their houses in order; that, being seen, we should not be ashamed; and, being heard, we should not be despised by our neighbours and friends.

**PRO BONO PUBLICO.**

The Carbrook and Carlisle Streets council schools in Sheffield have each been presented with wireless sets for the reception of educational programmes. The donors are private individuals.

o o o o

**WIRELESS FOR BRAZILIAN NEWS.**

A new organisation known as the Brazilian Press has received the authority of the Brazilian Government to maintain a wireless station for the receipt and distribution of news messages.

o o o o

**RADIO-TELEPHONY IN THE AIR.**

Among the attractions provided by the Air Ministry for the entertainment of the Dominion Prime Ministers at the Croydon Air Pageant on October 23rd was radio-telephony squadron drill by "Grebe" single-seater fighters. The evolutions performed were similar to those at the Hendon display last July.

**COFFEE CONCERTS.**

An enterprising coffee-stall keeper in South London has erected a wireless set and loud-speaker on his stall. Classical music is said to encourage the consumption of cheese cakes; coffee disappears more quickly during poetry readings.

o o o o

**COMING EVENTS . . .**

Pending the establishment of a regular Indian broadcasting service, listeners in the Bombay region are making the most of transmissions put out by the Bombay Radio Club, which is being supported by the local Traders' Association. Improved concerts are whetting the appetite of the Indian public for the "real thing."

o o o o

**A GOOD AMPLIFIER.**

A Pimlico resident recently made an unsuccessful application for a summons against the proprietors of a local cinema for alleged nuisance caused by a loud-

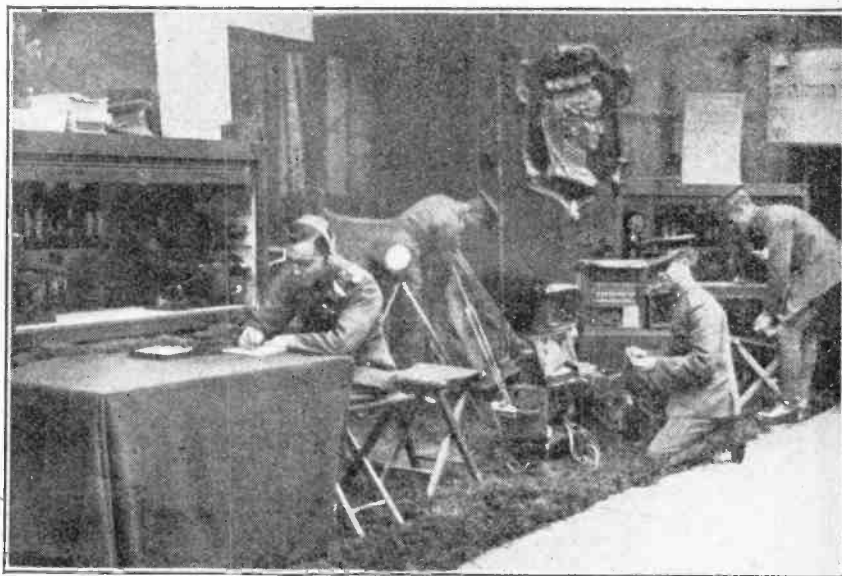

**THE MANCHESTER MANŒUVRES!** At the third Wireless Exhibition now being held in Manchester under the auspices of the "Evening Chronicle," interesting demonstrations are given of how wireless is used by an army in the field. The Exhibition will remain open until Saturday next, November 6th.

speaker in the entrance hall. It was pointed out by the inspector that the instrument was 20 yards from the street pavement.

○○○○

#### COAL MINE RADIO.

A wireless station is installed at the mines owned by the Swedish Coal Company at Spitsbergen to enable the pit manager to communicate direct with Sweden.

○○○○

#### WHY GO TO SCHOOL?

Children in lonely American farms are reported to be "going to school" by listening to broadcast lessons on their loud-speakers. Unfortunately, the angelic little creatures have to walk to the school house when they want the cane.

○○○○

#### BEAM SERVICE INTERRUPTED.

Owing to a widespread magnetic storm, a temporary failure occurred on Monday, October 25th, in the "beam" wireless service to Canada. Traffic for the time being was diverted to the cables, but wireless communication was speedily re-established. There has been a great rush of business in the department of the Central Telegraph Office administering the new service, a very large number of messages having been sent at the post-letter telegram rate.

○○○○

#### WIRELESS TRANSMISSION OF POWER.

A possibility that the wireless transmission of power might still be achieved was hinted at by Senatore Marconi in delivering the "James Forrest" lecture on "Radio Communications" at the Institution of Civil Engineers last week.

"I hope you will not think me too

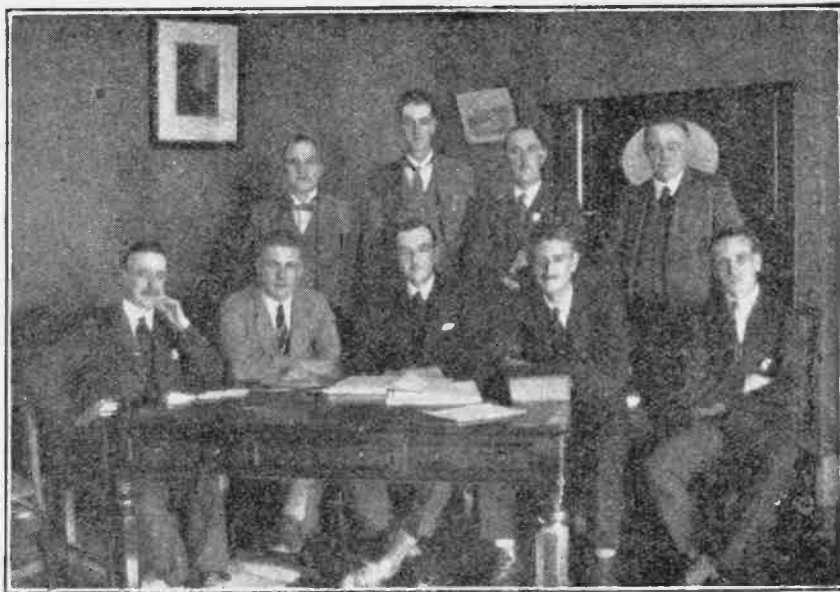

**WIRELESS LEAGUE SECRETARIES CONFER.** Officers of Wireless League branches in the West of England photographed at a recent conference. Seated (left to right): Messrs. A. Hitching (Bristol), W. O. Coate (Bridgwater), H. Munro Nelson (Bristol), A. S. Balshaw (Taunton) and S. G. Archer (Swindon). Standing: Messrs. P. Hagon (Bristol), C. A. Boakes (Plymouth), W. S. Trevenna (Redruth) and L. Trenaman (Barnstaple).

#### THE "NIFE" HIGH TENSION BATTERY.

We have been asked by the makers of this battery (Batteries, Ltd., Crabbs Cross, Redditch) to correct the statement in our review in the September 29th issue to the effect that 18 cells give a potential of 30 volts. Actually, 24 cells are required to give this voltage, and this is the number employed in the unit described.

#### WAVEMETERS FOR THE GENEVA SCHEME.

The delivery of calibrated wavemeters to stations participating in the Geneva plan has already commenced. These instruments have been made in Brussels and calibrated there against a harmonic tuning fork wavemeter, the frequency of which can be determined in absolute measure in terms of standard time.

Each station is to have its own wavemeter and the wavemeter for 2LO has already been delivered. Through the courtesy of Capt. P. P. Eckersley we have been able to examine this instrument.

The wavemeter is of the absorption type and consists of an inductance and capacity in parallel. The inductance is fixed and is supported on a "low-loss" former of great rigidity. The capacity consists of two parts, one of which is fixed and the other variable. The variable capacity constitutes only a small proportion of the total and is so arranged that a frequency change of 10,000 cycles on either side is available when the precise wavelength of the station is in the centre of the dial. The condenser consists of rotating concentric cylinders and is less susceptible to changes of capacity through malalignment, distortion, etc., than are condensers of the moving vane type.

Resonance is indicated first of all by a lamp coupled to the inductance by a single turn, the final reading being taken with a thermocouple and galvanometer connected in place of the lamp.

It is interesting to learn that this method was chosen in preference to the use of quartz crystals owing to the difficulty of grinding the crystal resonators with sufficient accuracy, and to the difficulty of adjusting the wavelength of the station to the single wavelength to which the crystal responds.



**AT THE TOTTENHAM SHOW.** Messrs. Wroth and Vickery are here seen at the short wave stand at the Tottenham Wireless Exhibition, which was held with great success on Thursday, October 21st.

visionary," remarked Senatore Marconi, "if I say that it may be possible that some day electric waves may be used for the transmission of power over moderate distances should we succeed in perfecting devices for projecting the waves in parallel beams in such a manner as to minimise the dispersion and diffusion of energy into space."

#### A CORRECTION.

In the advertisement of the Carrington Manufacturing Co., Ltd., which appeared on page 22 of the issue of *The Wireless World* for October 20th, the price of the "Fall Front" type of cabinet in mahogany should have been given as 70s., the stated price being inaccurate.





# MANCHESTER SHOW REPORT

## A Review of Outstanding Exhibits.

**E**NTHUSIASTS from all parts of Northern England were present at the City Hall, Deansgate, Manchester, on Tuesday, October 26, when the third Wireless Exhibition promoted by the Manchester *Evening Chronicle* was declared open by Sir William Noble.

Among those attending the ceremony were Captain P. P. Eckersley, Chief Engineer of the B.B.C.; Major Gladstone Murray, of the B.B.C.; Mr. E. Liveing, director of 2ZY, and Mr. R. Bird; Mr. J. E. Kemp, chairman of the Manchester and District Association of Radio Societies; and Mr. Maddan, Postmaster of Manchester.

The chair was taken by Dr. Ferranti, who, in a preliminary speech, dwelt on the part which Manchester had played in the development of wireless, particularly through the labours of amateur workers. He paid a special tribute to the keenness of the Radio Scientific Society of Manchester and to the foresight which had prompted the *Evening Chronicle* to take up the Society's idea of holding an annual wireless exhibition.

In opening the Exhibition, Sir William Noble gave a brief but striking review of the history of broadcasting in this country. "In 1922," said Sir William, "twenty firms applied to the Postmaster-General for authority to erect one or more broadcasting stations. Had the Post Office acceded to these requests we should have had in this country a condition of affairs more chaotic than was the early experience in the United States."

Sir William referred to the attitude of the sceptics in the early days, and their prophecy that broadcasting would only have a few months' boom! "Broadcasting is the greatest boon," said the speaker, "that has come to the nation in modern times."

Capt. P. P. Eckersley, in an appropriate speech, congratulated the *Evening Chronicle* on its enterprise. Dealing with the new Geneva scheme of wavelengths, which would come into operation during November, he admitted that certain difficulties would be encountered before finality was reached. Some inconvenience would be caused to listeners at first, but the changes would mean progress. In a reference to the new Corporation, Capt. Eckersley said that the intention of those who made the appointments was not that they felt the old board unsatisfactory, but that it was a constitutional anomaly for a service of broadcasting to remain in the hands of what critics might call a trade board.

The inaugural speeches were broadcast from the Manchester station and were followed by music from the Exhibition orchestra.

The general appearance of the Exhibition and the individual stands was distinctly pleasing and several of the stands displayed apparatus which had not previously been on view at the Olympia Show in London. In the pages which follow we describe and illustrate various components of special interest which attracted our attention on our visit to the Exhibition.



Photo: Manchester "Evening Chronicle."

**OPENING OF MANCHESTER'S THIRD WIRELESS EXHIBITION.** A group of celebrities on the platform at the City Hall, Manchester, on Tuesday, October 26th. Speaking into the microphone is Mr. A. Paterson (Allied Newspapers, Ltd.). On his left are Sir William Noble, Dr. S. Z. de Ferranti, Captain P. P. Eckersley, Mr. E. Liveing of 2ZY and Mr. J. E. Kemp, chairman of the Manchester Association of Radio Societies. On the left of the microphone is Major Gladstone Murray, of the B.B.C.

### Manchester Show Report.— STANDARDISING PLUGS AND SOCKETS.

The old type of terminal in which the connecting wire is screwed down in a hole suffered from the defect that thin wires were not satisfactorily gripped, the wire was apt to become cut, while two or more wires could not be properly accommodated unless twisted together. Another much used form consisted of a milled nut, the wire being twisted round the stem of the terminal. Here again, unless terminals are well spaced, fraying flexible wires may cause short circuits. The plug and socket connector has been developed to overcome these difficulties, but one finds that the plugs of the various manufacturers differ in size.

The new "Ealex" triple duty terminal combines the three forms of connector. A well-fitting split plug can be inserted at the top, the head screws down to grip a flexible wire or spade terminal, while a hole through the body of terminal will grip a second plug, pin, or stiff wire.

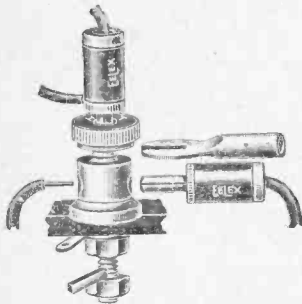

The Ealex terminal will accommodate a wire lead, a flexible, as well as spade and plug connectors.

On the underside, in addition to the nut and tag, the stem is split to take the instrument wiring. A coloured label is fitted in a recess at the top. The adoption of well-finished terminals, arranged to accommodate several connecting leads, adds much to the appearance and convenience of operating a receiving set.

J. J. Eastick & Sons, 118, Bunhill Row, London, E.C.1.

### ACCUMULATORS WITH GLASS CONTAINERS.

The popularity of the celluloid cased accumulator is declining. Whether or not frothing is due to the use of celluloid, and is inevitable when celluloid is used, is difficult to say. Experience shows, however, that when glass boxes are adopted frothing during charging does not occur, and in consequence the outside of the battery is kept free from acid.

The Tungstone battery is now available for wireless purposes, fitted with glass containers. The plates of the Tungstone battery, instead of being built with a grid of hardened antimonious lead alloy, are composed of pure lead sections clamped in alloy frames. Another interesting detail of construction in the 40-ampere-hour cell, which consists of three negative

and two positive plates, is that the centre negative is much thicker than the outside negative plates. The latter face the positive plates only on one side, while the former—that is, the thick plate—is between the positives.

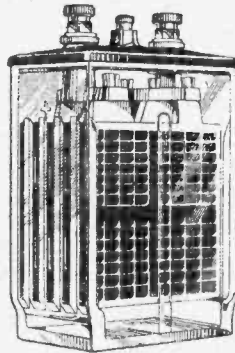

Tungstone cell in glass container. The centre negative plate is thicker than those on the outside.

The moulded lid is polished to facilitate cleaning, and, after charging, can be easily wiped dry.

Tungstone Accumulator Co., Ltd., 3, St. Bride's House, Salisbury Square, London, E.C.4.

o o o o

### NEW BRETWOOD RHEOSTAT.

A change from the common type of rotary filament resistance is to be found in the Bretwood rheostat, in which the filament current is controlled by a plunger action. In order to limit the movement of the plunger, the resistance is wound on a drum nearly 1 in. in diameter.

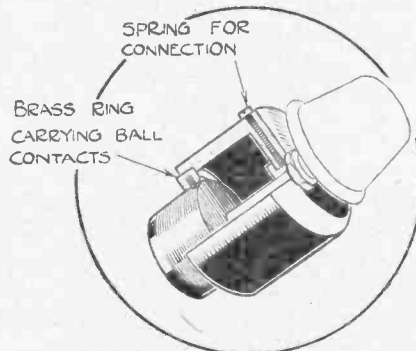

New Bretwood plunger-action rheostat. Minimum to maximum resistance is obtained by a movement of about 1 in. so that the operating knob does not project unduly from the face of the panel.

The wire is carried in a thread, and contact is made by means of three small bronze balls held in recesses in a brass ring. Fine adjustment is obtained by rotating the control so that the drum advances slowly by the action of balls resting in the spiral thread.

An ebonite cylinder forms the body of the rheostat, and the resistance wire is carried on a fibre cylinder, while minimum to maximum adjustment is given by a plunger movement of about 1 in.

### NOVEL CONDENSER DESIGN.

An unusual form of construction is adopted in the new variable condenser of Bretwood, Ltd. The aim has been to eliminate the stray capacity by mounting the plates at right angles to the front of the panel. The moving plates are controlled through a worm and wheel drive, the operating spindle being insulated by making the worm wheel of hard fibre, which incidentally gives a durable and smooth movement. Backlash is prevented by firmly meshing the worm drive, and is assisted by a steel spring, which, moreover, takes up wear. This form of drive gives a reduction gearing ratio of

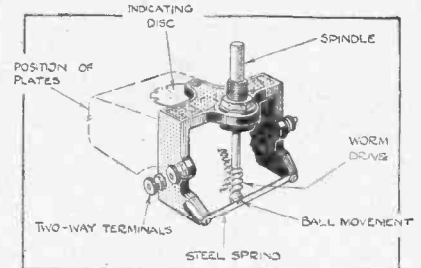

Novel form of condenser mounting, arranged to keep hand capacity to a minimum

about 40 to 1, so that ten complete turns of the dial are required between the minimum and maximum setting, giving a particularly fine adjustment. The plates, which are of brass, are silver-plated.

Bretwood, Ltd., 12-18, London Mews, Maple Street, London, W.1.

o o o o

### LOUD-SPEAKER WITH CELLULOID DIAPHRAGM.

To employ transparent celluloid as a loud-speaker diaphragm is an entirely new departure. The finding of a non-resonant material for the construction of loud-speakers of the cone type is the aim, and a pliable soft celluloid sheet would

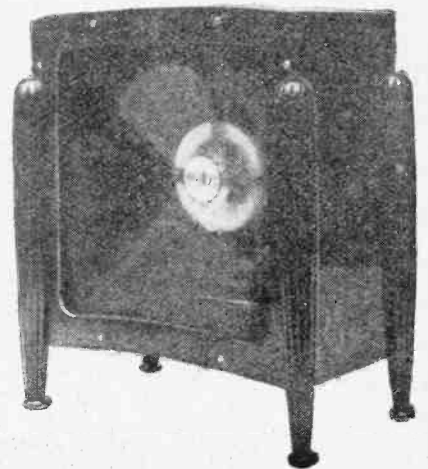

A new loud-speaker, making use of an almost non-resonant celluloid diaphragm, and in which reed resonance is modified by a bronze damping spring.

**Manchester Show Report.**— seem, to a large extent, to fill this requirement. In addition, celluloid can be shaped to a conical formation, so avoiding the need for a seam.

A diaphragm of celluloid is employed in the "Saldana" loud-speaker, which is of foreign manufacture and sold in this country by L. Kremner. Overall, the loud-speaker measures some 11in. in height by 10in. wide by 15in. deep, and the diaphragm is about 7½in. in diameter. The movement is of standard design and is fitted with a stiff iron reed, to which a cross-piece of spring bronze is bolted to modify its resonance as far as possible. The usual form of adjusting screw controls the distance between the reed and the pole pieces, and an additional screw action is fitted in the centre of the diaphragm to regulate the pull on the celluloid cone, which dips inwards at an angle of about 30 degrees.

L. Kremner, 49a, Shudehill, Manchester.

CHOKE COUPLING UNITS.

When it is desired to maintain the best quality of reproduction from a low-frequency amplifier, the use of choke capacity coupling can be recommended, so that a very high value of inductance can be inserted in the plate circuit of the valve, and the potential adequately handled in the next amplifying stage by the avoidance of step-up ratio.

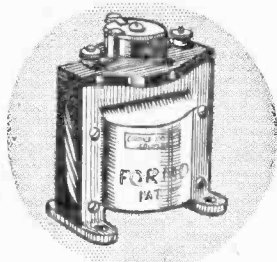

The Formo choke capacity unit.

Among the products of the Formo Company is a choke-capacity coupling unit, which, in addition to the L.F. choke, includes a mica coupling condenser and grid leak. The manufacturers state that the winding consists of some 15,000 turns, and the wire is No. 42 S.W.G.

It is interesting to note that instead of using a terminal strip, Formo transformers have been modified, and the terminals are now supported on small ebonite bushes pillars. The terminals are labelled, showing the actual connections instead of the usual I.P., O.P., etc.

Formo Company, Crown Works, Cricklewood Lane, London, N.W.2.

A VERNIER CONTROL.

Undoubtedly the simplest form of vernier adjustment consists of a small spindle rotating against the edge of the tuning dial. A good form of construction for such an auxiliary control is adopted in the "Jhester" vernial control. A metal plate is clamped down under the one-hole fixing nut of the condenser

to which is secured a lever carrying a small milled wheel. The latter is driven into firm contact with the edge of the dial by a spring, so that there is neither backlash nor slip. Another lever in the form of a trigger is provided to throw the vernier control out of action.

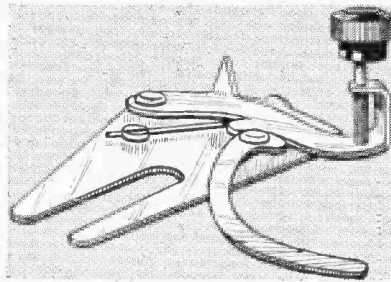

A novel form of vernier control, consisting of a small milled wheel which is thrown out of action by a trigger. The mechanism is entirely hidden underneath the instrument dial.

Occupying very little thickness, this vernier device can easily be accommodated under a recessed dial, while even a solid dial will not be lifted more than ¼in. above the surface of the panel. The action is entirely hidden away under the condenser. It is suitable for use with dials of various diameters.

AN ATTACHMENT FOR VOLUME CONTROL.

Although marketed as a "tone clarifier," a very useful attachment is now obtainable, consisting essentially of variable resistance, which, used as a shunt in the output of a set, provides a useful control of volume. It is built in the form of a circular moulding fitted at the ends with input and output terminals. One of the terminals is rigid, so that the device is supported, when clamped down, under one of the terminals of the set. The other input terminal is attached to a short flexible lead. Adjustment is obtained by means of a dial with a projecting milled edge, and a number is revealed through a small hole which serves as an indication of the resistance in circuit.

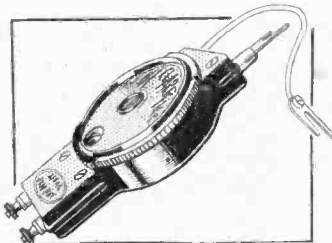

"Blue Spot" volume control, which consists of a 6-position shunt resistance.

The importance of critical volume control is now appreciated, for although a loud signal may overload a loud-speaker, insufficient signal strength causes apparent distortion by eliminating the bass notes. Critical adjustment of volume is

essential and can conveniently be provided in this way by means of shunt output resistance.

Tutills, Ltd., 7 and 9, Swan Street, Manchester.

IGRANIC BATTERY SUBSTITUTES.

One of the first of its class is an L.T. battery eliminator designed to supply filament current direct from alternating-current mains. The apparatus comprises a full-wave arc rectifying valve, the output of which is fed to a dry accumulator, which in turn feeds the filament heating supply to the output terminals. The apparatus is not what is commonly known as



Igranic L.T. battery eliminator, by means of which filament heating supply can be obtained from alternating current mains. It is not a trickle charger.

a trickle charger, for the accumulator battery is not on charge at the time it is not in use, and is, therefore, employed more as a smoothing device than as a storage battery. The output from a battery on charge from A.C. supply is by no means smooth, and consequently a very liberal



The H.T. battery eliminator of the Igranic Electric Co. A full-wave rectifier is employed and three potential outputs can be obtained.

smoothing circuit consisting of a large bank of condensers is fitted. In addition to a double-pole main switch, a meter is fitted together with a rheostat for voltage control as well as an easily accessible fuse. The entire equipment is enclosed in a metal box, which not only provides the necessary screening, but renders the instrument both attractive and durable. The unit is arranged for delivering a maximum current output of 1.5 to 2 amperes, at either 2, 4, or 6 volts.

For H.T. supply another unit, somewhat similar in external dimensions to the L.T. eliminator, is available, which

**Manchester Show Report.—**

consists of a full-wave valve rectifier, giving a liberal output, the several voltages being obtained by means of a potential divider. The smoothing equipment is particularly liberal, and comprises a pair of chokes and a large bank of condensers. Three voltage outputs are normally provided, voltage regulation being obtained by tapping at every 25 volts.

o o o o

**THE NEUTRO-SONIC SEVEN.**

A compact seven-valve super-heterodyne receiver is now manufactured by the Igranic Electric Co. The circuit makes use of a high-frequency amplifying stage, which, together with the frame and oscillator tuning adjustments, necessitates the use of three controls. The sequence of the seven valves is high-frequency amplifier, oscillator, first detector, two intermediate amplifiers, second detector, and low-frequency amplifier. There are many features in the design which are novel.



Igranic "Neutro-sonic Seven." A high-frequency amplifying stage precedes the first detector valve and a wide wavelength range is obtained by interchangeable tuning units.

For instance, the tuning range is varied by means of plug-in units, and as a high-frequency stage is embodied the change of coils is not an easy matter. The difficulty is overcome in a very satisfactory manner by combining together the several inductances as a single unit. To avoid disturbing the windings of the tuning unit a moulded case is provided which includes the coils and carries all necessary connections. The intermediate amplifier is screened to prevent pick-up of long-wave stations, and for the same reason the frame aerial is built in several sections.

The large number of battery connections which are necessary are readily made with the aid of a plug and socket connector, the batteries being carried in a case which forms a unit of approximately the same dimensions as the set. The construction and compact design render this set particularly suitable to the requirements of the motorist.

**SPRING PLUG AND SOCKET.**

A new system for making a simple and reliable connection has been introduced by the Igranic Electrical Co. in their new plug and socket connector. The plug is in the form of a spring clip, and the sharp edges spring apart to make a reliable contact with the walls of the socket.

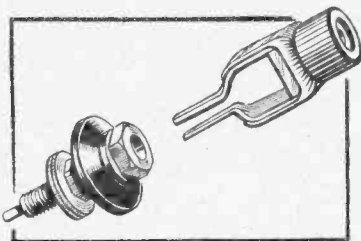

The Igranic plug connector consists of a spring clip. An insulating covering prevents the fingers from making contact with the conductor.

The plug is protected by an insulating covering, so that it is impossible for the fingers to make contact with the conductor. The plug is mounted on a small Bakelite moulding, which raises it slightly above the surface of the panel. It is fitted with back nuts and washers, as well as a small stem reduced in diameter, so that connection to the wiring can be made either by clamping down or soldering.

This plug and socket connector is well finished, and may be adopted where an attractive appearance is required.

Igranic Electrical Co., Ltd., 147, Queen Victoria Street, London, E.C.

o o o o

**BRANDES VARIABLE CONDENSER.**

Brandes, Ltd., have now added to their range of components a variable condenser which embodies several new points in its favour. The plates, which are of thin between spacing washers, support for the fixed plates being provided by two sets of ebonite collets. Play of the spindle

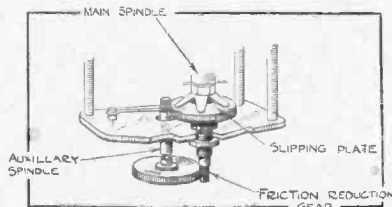

Reduction gearing of the new Brandes variable condenser. It is fitted with a ball thrust bearing, Bakelite knob and dial and is built throughout of brass.

is controlled by means of a ball thrust bearing at one end of the shaft and a substantial spring washer at the other, the latter incidentally providing the friction between the quick and vernier movements.

The reduction gearing operates through an auxiliary knob and two pairs of pinions. Friction drive is provided be-

tween the pinions, thus preventing backlash, the smaller pinions being of brass, and the larger ones of hard fibre. Milling of the surfaces between the pinions ensures a good grip, while they are kept firmly pressed together with the aid of a pair of stiff springs. There is no backlash in the movement. All metal parts are of brass and finished bright, and both knob and dial are clean Bakelite mouldings.

Brandes, Ltd., on the stand of B.N.B. Wireless, Ltd., 65, Renshaw Street, Liverpool.

o o o o

**CONDENSERS WITH CYLINDRICAL PLATES.**

A novel form of construction has been adopted in the monoblock variable condenser. The two sets of plates are arranged as concentric cylinders, the moving set advancing towards the stationary plates by means of a quick-acting thread.



Variable condenser, fitted with concentric cylindrical plates, the moving section being operated by a quick acting thread.

on the central shaft. One complete rotation of the dial changes the capacity from minimum to maximum. The plates are of heavy construction and are probably die cast. They are protected from dust by means of an outside cover.

The merit of this condenser is that it occupies very little panel space as compared with other types, where the moving plates, in swinging away from the fixed ones, sweep a large area.

F. A. Hughes and Co., Ltd., 204-206, Portland Street, London, W.1.

o o o o

**BASE MOUNTING RHEOSTAT.**

There are very few filament rheostats which are suitable for screwing down on to a baseboard. The now general form of set construction in which the majority of the components are mounted on the base and only the tuning controls on the



**Manchester Show Report.**—  
ebonite front has created a demand for  
rheostats of this type. The "Ether-  
plus" rheostat, although designed for  
panel mounting, is supplied with a  
nickelled brass bracket, so that it can be  
supported from a base. An ebonite bush  
insulates the centre spindle from the  
bracket.

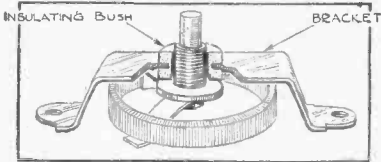

Etherplus rheostat, fitted with bracket  
for baseboard mounting.

A good point in design is the provision  
of a recess under the knobs so as to give  
clearance to the one-hole fixing nut, thus  
permitting of the pointer resting close  
down against the scale. Although of very  
simple construction and inexpensive, this  
rheostat possesses a good finish.

o o o o

**RUBBER-SUPPORTED VALVE  
HOLDER.**

Making use of a Bakelite moulding as  
an outer support, the valve pins of the  
"Etherplus" valve holder are carried on  
an indiarubber disc. The pins, after pass-  
ing through the rubber, are clamped by

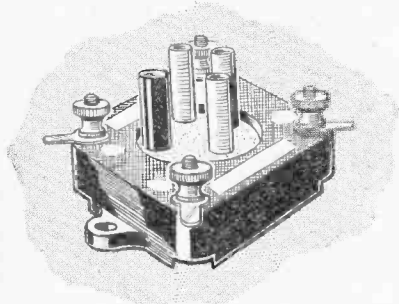

The "Etherplus" valve holder. A rubber  
disc supports the valve pins.

metal strips to the terminals; yet it is  
due to the pliable nature of that portion  
of the rubber which is situated between  
the pins that a shock-proof support to  
the valve is obtained.

"Etherplus," on the stand of the Deans-  
gate Electro Radio (Manchester),  
Ltd., 240, Deansgate, Manchester.

o o o o

**VIBRATOR RECTIFIER.**

The merit of the vibrator form of A.C.  
rectifier for battery charging is princi-  
pally that no renewals are required.  
Reasonably high efficiency is obtained, for  
there is no power lost, as in cases of  
other forms of rectifiers for filament heat-  
ing or decomposing electrolytic solutions.

The "Goltone" battery charger, which  
is a full-wave vibrator rectifier, is fitted  
with a step-down transformer, field coils,  
double contact and polarised armature.  
It is capable of charging 2-, 4-, or 6-volt  
batteries at a rate of 2 amperes, regula-

B 11

tion for the different output voltages  
being obtained by small series resistances.  
The manufacturers state that for 100  
hours' running the energy consumed is  
between 3 and 4 units.

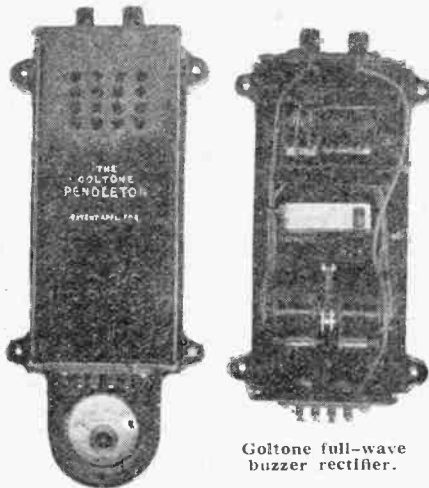

Goltone full-wave  
buzzer rectifier.

**FULL-WAVE H.T. BATTERY  
ELIMINATOR.**

The Goltone H.T. battery eliminator  
is a full-wave rectifying set employing an  
Osram U5-type valve. As the output  
obtained with this valve is far in excess  
of requirements, the shunt potentiometer  
method of potential dividing may safely  
be adopted for giving several output vol-  
tages. A good feature is the provision of  
a double row of output sockets, so that  
more than one plug can be inserted at a  
particular tapping on the potentiometer.  
A metal screening box encloses the ap-  
paratus.

Ward and Goldstone, Ltd., Frederick  
Road, near Manchester.

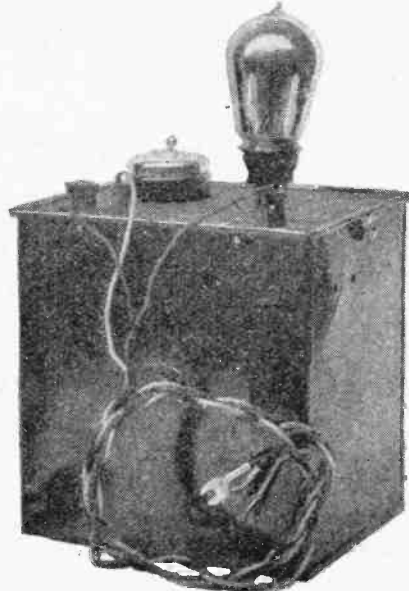

The Goltone A.C. high tension battery  
eliminator is a full-wave rectifier em-  
ploying the potentiometer method for  
providing several output voltages.

**THE CARBORUNDUM DETECTOR.**

Long before the invention of the three-  
electrode valve, carborundum was in  
general use as a rectifier, and it was, in  
fact, one of the earliest forms of crystal  
detector. Although not considered as the  
most sensitive of detectors, it possessed  
the important merit of stability. Develop-  
ment of the carborundum detector has not  
ceased, for the Carborundum Company  
have now produced a new form, which is  
undoubtedly sensitive and is sufficiently  
robust to abandon the fitting of an ad-  
justing screw.

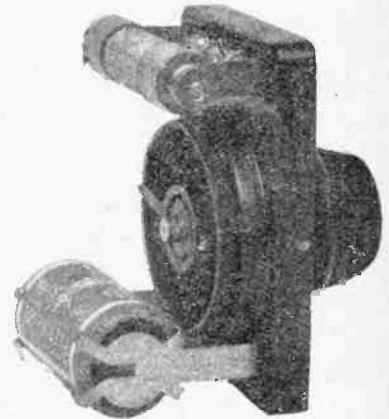

Carborundum high resistance detector  
with potentiometer and battery unit.

The efficiency of a crystal is usually  
gauged by comparing its conductivity in  
one direction with that in the other. This  
detector is demonstrated with an applied  
potential of 3 volts, the current in one  
direction being about 20 mA, while in the  
other no deflection can be discerned on a  
low reading meter. Being a high-resist-  
ance detector, it is more suited for con-  
necting across the entire tuning induct-  
ance, for although this is the usual prac-  
tice, many of the low-resistance detectors  
give rise to very considerable damping.

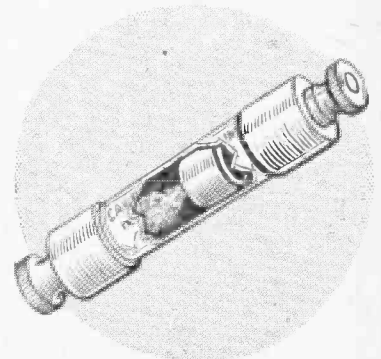

Internal construction of the Carborun-  
dum detector. The specimen of crystal,  
although possessing the iridescence of  
carborundum, is actually transparent.

Another important point is that, as the  
adjustment is fixed, the damping pro-  
duced across a tuned circuit is always  
constant — an important consideration  
when reaction is used to nullify the effects  
of resistance.



**Manchester Show Report.—**

The detector is of heavy construction, and it is interesting to observe that the specimen of crystal fitted is in the form of an iridescent transparent plate. As carborundum works best with an applied potential, a unit is available comprising a single-cell battery, centre tapped potentiometer, detector clips, and shunt condenser. A useful booklet is obtainable from the Carborundum Company showing how the detector can be substituted in a number of circuits in place of the detector valve.

**The Carborundum Company, Ltd., Trafford Park, Manchester.**

o o o o

**NEW LAMPLUGH CONDENSER.**

A departure from the usual form of bevelled scale has been made in the new Lamplugh condenser by way of adopting a chemically engraved dial with silvered finish and black lettering and a unique form of pointer

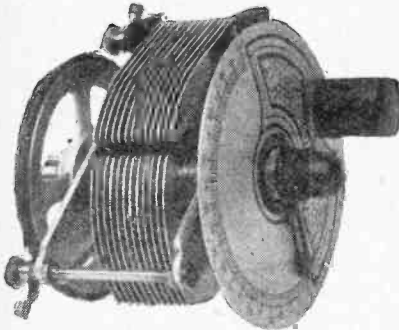

New type Lamplugh condenser. The adoption of chemically engraved dials is a feature of Lamplugh components.

The condenser is operated through an auxiliary shaft, which drives a large-diameter cast aluminium wheel giving the necessary reduction for critical control. This wheel has a turned rim to accommodate a rubber band for the reducing gear, and, being polished and fitted with a smooth nickelled centre, gives the condenser a workmanlike appearance. Polished aluminium is also used for the construction of the end plates. Fixed and

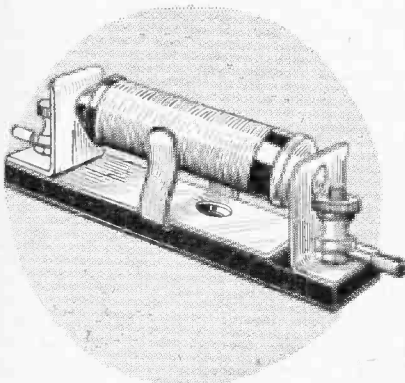

A "fixed" resistance that can be varied. The resistance spoils of the Lamplugh baseboard rheostats are interchangeable and adjustable.

moving plates are spade-shaped, like earlier Lamplugh condensers. End thrust is adjusted by a conical bearing and split spring washer.

o o o o

**VARIABLE "FIXED" RESISTANCE.**

So that fixed valve filament resistances can be adjusted in the first instance to the most suitable value, the Lamplugh resistance spool is fitted with a sliding contact. It is designed for baseboard mounting and is obtainable wound to resistances of 6, 15, and 30 ohms. The resistance spool is interchangeable in the mounting clip.

**S. A. Lamplugh, Ltd., King's Road, Tyseley, Birmingham.**

o o o o

**FUSES IN BATTERY CORDS.**

The best position to insert protecting fuses in the current supply to a receiver is as near as possible to battery terminals. Short circuits, apart from those arising from errors in wiring, generally occur at the terminals of the set, and therefore fuses are not really effective when enclosed in the receiver. To meet this requirement the Standard Insulator Co. have introduced a battery cord with fuses permanently connected in the leads. The fuses, which are mounted between clips so as to be easily replaceable, are contained under a moulded bakelite cover, and are connected in the positive L.T. and the negative H.T. leads. As soon as the current in the H.T. lead exceeds 0.18 amperes the fuse breaks the circuit, so that filament burn-outs by

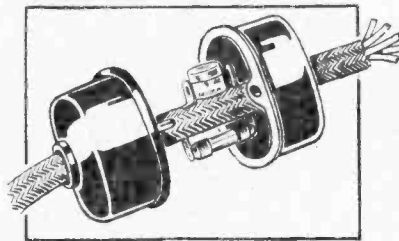

Belden battery cord fitted with replaceable H.T. and L.T. fuses, protected under a moulded cover.

contact with the H.T. supply are prevented in all cases where current taken is greater than that required to run two valves of the .06 type.

Cords are available containing five or seven connectors.

o o o o

**LIQUID SOLDER.**

The convenience of using a combined solder and flux is not appreciated by many amateurs. Such a mixture in the form of a paste can be applied and will adhere to the joint, while after the solder has run no excess of flux remains. The finely divided solder is, of course, perfectly clean, and the small particles are easily melted.

One must be satisfied, however, that a corrosive flux has not been used in the making up of such liquid soldering compounds. That "Flusoid," a product of the Northern Steel and Hardware Co., does not contain acid is re-

vealed by the absence of pungent fumes when heated, and, on the other hand, there is evidence of burning resin, which is the safest flux for use in wireless set construction.

This soldering compound "runs" at a low temperature, yet it contains only tin and lead, and the introduction of low melting point metal has been avoided. Even an end-to-end joint between two pieces of No. 16 wire soldered with the compound is strong enough for ordinary wiring.

**The Northern Steel and Hardware Co., Ltd., 9, South Parade, Manchester.**

o o o o

**THE "DIALOG" DIAL.**

Friction wheels are now generally employed in the design of reduction geared dials. The system in which three floating wheels engage on a centre spindle

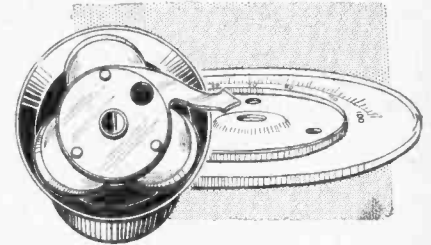

Simplicity of construction with absence of loose parts is a feature of the "Dialog" dial. The reduction gearing is driven through friction wheels.

and a stationary plate on the instrument panel has become almost standard practice. In applying the principle in the "Dialog" dial a remarkably simple form of construction has been adopted. Few parts are used, there are no loose rings or screws, and yet the action is entirely reliable and robust.

The knob is a clean moulding of pleasing shape, and the 4in. dial, which is of brass, has a silvered finish and black scale, and is slightly lifted above the surface of the panel by a raised rim.

**The Standard Insulator Co., Ltd., Winsley House, Wells Street, Oxford Street, London, W.1.**

o o o o

**NOVEL REDUCTION GEAR.**

It is usually less expensive to incorporate the reduction gearing for giving critical control in the variable condenser itself than to fit a geared dial. In the "Simplicon" condenser a very compact action for giving fine adjustment is contained in the top bearing, and occupies very little space. The main spindle is hollow, and the operating knob is locked on to a centre shaft. This shaft engages on the faces of three 3/8in. steel balls which protrude through holes in the spindle, and in turn make friction contact on the walls of a stationary hollow cup. The balls are rotated by the centre shaft, and in moving on the face of the cup impart a drive to the spindle. The reduction ratio is dependent upon the relative diameters of the centre shaft and the inside of cup, and is about 10 to 1. It is doubtful if a greater reduction ratio

**Manchester Show Report.**— is ever needed, while rapid search over the entire tuning range is obtainable.

The fixed plates are bolted together at three points, and secured to the frame by three ebonite bars, which is a reasonable modification of the two or four bars usually employed, the former in some cases giving rise to mechanical and the latter electrical defects.

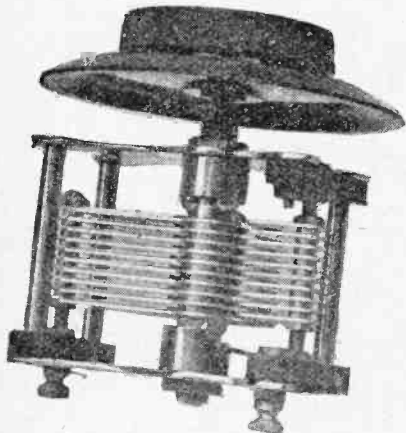

A self-contained reduction gear is incorporated in the top bearing of the Simpicon condenser and occupies very little space.

The end plates are of nickel plated brass, and a strip pig-tail connector is fitted. The knobs and dial are of bakelite. Evidence of absence of slip in the gear is obtained by rotating the moving plates and observing that the centre operating knob revolves at a rate several times faster.

Williams & Moffat, Ltd., Grange Road, Small Heath, Birmingham.

**P.O. PATTERN EARTHING CLIP.**

There is little doubt that the form of earthing clip used by the Post Office affords one of the most effective means of producing a reliable earth connection.

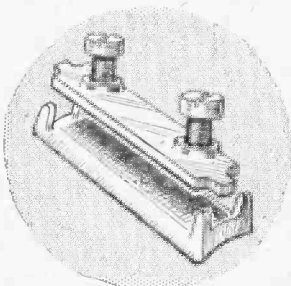

The P.O. form of earthing clip. It is secured to a pipe with binding wire, and by driving the screws home the wire is tightened and pulled up into firm contact with the pipe.

It consists of two cast brass pieces, one of which is curved on the underside to fit to the surface of a pipe, and the other bar with a pair of screws. After scraping the surface of the pipe quite clean, the clip, with one piece resting on the other, is bound tightly in position, using hard copper or bronze wire of not less

than No. 18 S.W.G. By tightening the screws the wire binding is pulled up firmly into contact with pipe.

Being of brass, the clip will not rust or corrode. The tightening screws are of iron, so that rusting of the threads will prevent them from becoming loose. Spring Washers, Ltd., Eagle Works, Alexandra Street, Wolverhampton.

**THE PHILIPS BATTERY CHARGER.**

When a battery charger working from A.C. supply is required that can be safely left unattended, the "arc" form of rectifier is recommended. The Philips rectifier of this type is capable of charging one to seven cells, and has three outputs, 6 volts at 3 amperes, 6 volts at 6 amperes, and 12 volts at 3 amperes. No adjustment is required for the varying load.

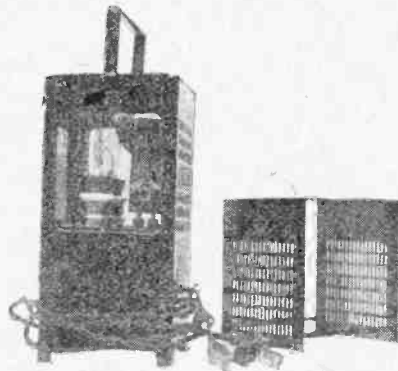

The Philips gas discharge (or arc) rectifier. This form of battery charger can be left running unattended.

The valve form of arc rectifier which is fitted has two plates, so that full-wave rectification can be obtained. The valve is "soft," and contains a small quantity of residual gas. The filament is heated by a current of roughly 14 amperes at 3 volts. The anode current is regulated by two resistance lamps.

For battery charging during the night this form of rectifier can be adopted, being reliable and safe. The efficiency is good, and only a small current is consumed from the mains.

**WANDER PLUG FUSE.**

Wander plugs fitted with fuses not only protect the high tension battery against overload, but if suitably constructed will prevent the burning out of valve filaments should they come accidentally into contact with H.T. potential.

The Philips wander plug contains a

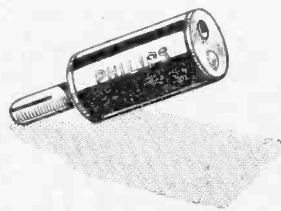

The Philips wander plug is fitted with a fuse capable of preventing damage to valves should the filaments come into contact with the H.T. potential.

sealed-in fuse wire carried in a glass tube. It is carefully adjusted to burn out almost instantaneously with a lower current than is required for filament heating.

Philips Lamp, Limited, 145, Charing Cross Road, London, W.C.2.

**TRADE NOTES.**

**A Circuit Guide.**

An ingenious idea on the part of the Igranic Electric Co., Ltd., has resulted in the production of a "Multi-Circuit Folder," which should prove of some assistance to beginners. By altering the folds of the card, which is divided into several sections, various pictorial and theoretical circuits are shown, ranging from a simple crystal to a four valve receiver.

**Echo of the Dempsey-Tunney Fight.**

A Clapham listener has written an interesting letter to Messrs. The Igranic Electric Co., Ltd., relating his experiences in picking up the broadcast of the World's Heavyweight Championship Fight on September 24th.

"The efficiency of your short wave coils," he writes, "tempted me to rise at 2.30 this morning in the hope of hearing the fight broadcast. I tuned in within two minutes to 2NAF on 32.79 metres and held it without a break till 4 a.m., when I had to close down. There was a certain amount of fading, but not enough to prevent me hearing practically every word from the ringside, and the progress of the whole ten rounds was followed with intense interest. The set used was a three-valve (0-v-2), and the circuit similar to the one you publish in the pamphlet describing the coils."

**Monomarked Wireless Apparatus.**

A single piece of crystal, eleven pounds in weight, is to be seen in one of the windows at Monomark House, High Holborn. This gigantic specimen is flanked by piles of small pieces arranged to form the Monomark of the exhibitor — BCM/JR, to which members of the public are invited to write for information. BCM/JR is the monomark of Mr. J. Rigant, of 108, Euston Road.

**The Dublin Wireless Exhibition.**

At the Irish Wireless Exhibition now being held at the Mansion House, Dublin, the General Electric Co., Ltd., Magnet House, Kingsway, W.C., are exhibiting a comprehensive range of "Gecophone" sets besides a variety of "Gecophone" components such as high tension battery eliminators, loud-speakers, variable condensers, transformers and chokes.

**Interesting Price Reduction.**

Messrs. Radio Instruments Limited, have reduced the price of the R.I. Multi Ratio Transformer to 25s.

# INVENTIONS OF WIRELESS INTEREST

The following abstracts are prepared, with the permission of the Controller of H.M. Stationery Office, from Specifications obtainable at the Patent Office, 25, Southampton Buildings, London, W.C.2, price 1s. each.

**H.T. from the Mains.**  
(No. 247,213.)

Convention date (U.S.A.), February 6th, 1925.

One of the greatest troubles in the utilisation of valve rectifiers for obtaining high tension from the mains lies in the regulation of the voltage. For example, when a somewhat considerable load is put upon the rectifier and its associated smoothing circuit, considerable voltage drop results, which makes the adjustment of the receiving system with which it is used somewhat difficult. A

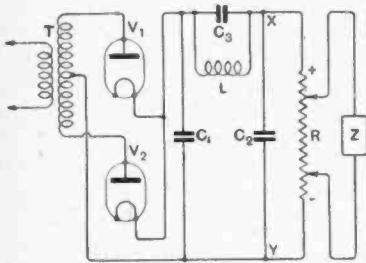

Rectifying unit with constant load. (No. 247,213)

method of overcoming this trouble is claimed in the above British patent by Marconi's Wireless Telegraph Company, Limited, and F. H. Kroger. Essentially, the invention consists in placing a steady load in the form of a resistance across the output of the rectifier and its filter circuit. The accompanying illustration shows one form of the invention. A transformer T supplies the high tension voltage to two rectifying valves  $V_1$  and  $V_2$ , the usual filament supply not being shown. The output from the rectifier is taken through a smoothing circuit consisting of condensers  $C_1$  and  $C_2$  on each side of a circuit  $LC_1$ . Across the output, i.e., at XY, is connected a resistance R. The load which, for example, may consist of the current taken by a receiving set, is shown as Z, and it is connected across the resistance R. The value of

the resistance R is such that the current flowing through it is very considerably greater than that taken by the load circuit Z. Thus, as soon as the resistance R is connected across the output of the filter a somewhat heavy current will flow through it, and will be accompanied by a certain volt drop. Obviously, then, when the load circuit is connected across the resistance R the amount of current which it takes will be very small compared with that flowing through the resistance, and accordingly there will be no potential change across the resistance R. In other words, the voltage regulation of the whole system will be practically constant, and any variation in the load circuit, such as might be caused by switching on another valve, will tend to lower the voltage which is applied to all the valves in the load circuit, i.e., the receiving system which is being employed.

o o o o

**Stabilised Amplifier.**  
(No. 257,122.)

Application date, October 20th, 1925. This form of stabilised amplifier is claimed in the above British patent by L. L. Jones. The patent specification is rather detailed and lengthy, and several alternative modifications and arrangements are shown. Essentially, the invention consists in providing a valve with a critically

tuned input circuit, and arranging a non-tunable output circuit, the natural frequency of which is greater than the highest frequency to which the input circuit will be tuned. The accompanying illustration shows one form of the invention, as applied to a six-valve receiver, five high-frequency valves, and one detector being employed. The first valve  $V_1$  has connected between the grid and the filament a critically tuned circuit in the form of a frame aerial  $L_1$ , tuned by a condenser  $C_1$ . The anode circuit contains a resistance  $R_1$  of about 1,000 ohms, in series with an inductance  $L_2$ , the natural frequency of which is greater than the highest frequency to which the input circuit can be tuned. This is coupled to another tuned circuit  $L_3 C_2$ , connected between the grid and filament of the second valve, the anode circuit being similar to that of the first valve, except in the value of the resistance  $R_2$ , which is of the order of three to five thousand ohms. The anode inductance  $L_4$  is coupled to another inductance  $L_5$ , which, in this case, is not tuned. The remaining valves  $V_3, V_4$  and  $V_5$  are coupled to the detector valve  $V_6$  by inductive impedances  $L_6, L_7$  and  $L_8$  in series with the resistances  $R_3$  and  $R_4$ , the anode circuit of the valve  $V_4$ , however, containing only an inductive impedance  $L_7$ . The last valve,  $V_6$ , is used as an ordinary detector, and contains the telephones T.

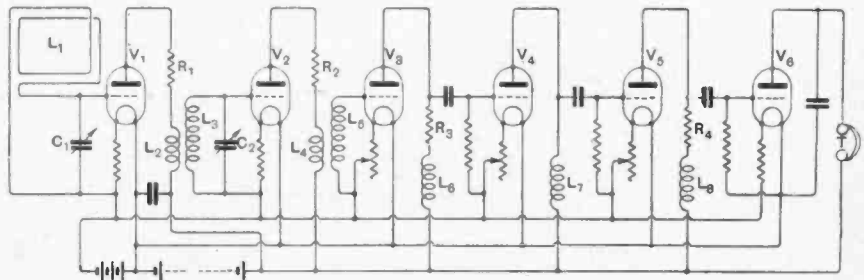

Stabilised H.F. amplifier circuit. (No. 257 122)

# THERMIONIC AERIAL AMMETER.

An Accurate Method of Measuring small H.F. Currents suitable for Low-power Transmitters.

By G2AB.

THE method about to be described may be recommended in any case where currents to the order of milliamps have to be considered. This condition may arise in the measurement of the current in an aerial when supplied with very low inputs. A typical example will be found in the forthcoming low-power 5-watt tests on short waves.

The method requires a thermionic valve, preferably of rather special construction, although any thermionic valve may be used for the purpose.

### Type of Filament Required.

The particular characteristics required for the best results with the foregoing scheme are as follow:—

The filament must have a fairly even filament watt emission ratio throughout, with a fairly considerable range of filament current. That is to say, if the filament current be increased from some definite value by a few milliamps, a correspondingly large increase must take place in the plate current. This can only be obtained when using a very thick, short filament having a low resistance, taking a relatively high current (0.3-0.5 amps) at a potential of 0.7-0.9 volts.

This fact may be made use of to measure small high-frequency currents, or, for that matter, quite large ones, provided that the filament of the valve is shunted by a suitable radio-frequency shunt, or that the filament is sufficiently large to carry the requisite extra current to be measured. However, for our purpose a valve capable of dealing with 50 to 100 milliamps of extra current would be sufficiently large. The A.C.1 fulfils this range of measurement.

### Suitable Valves.

It is suggested that if the A.C.1 valve is not used, a valve should be selected having a filament current consumption of not less than  $\frac{1}{2}$  amp., such as the D.F.A.4, P.M.254, P.M.256, or P.M.2. Of these last four valves the P.M.254 or P.M.256 are probably the best.



The Mullard A.C.1 valve.

The arrangement shown in Fig. 1 is suitable for measuring a current of 5 milliamps.

Z is the ordinary 5-watt transmitter.

$L_1$  is the ordinary coupling coil of perhaps two turns, which is used to transfer energy from the transmitter to the aerial-counterpoise system.

$L_2$  and  $L_3$  are two radio-frequency chokes capable of carrying the maximum current that the filament will stand, and having sufficient inductance to prevent leakage of radio-frequency currents from the aerial-counterpoise system.

R is a resistance of, say, 5 ohms.

$A_1$  is an ammeter with a fairly open scale reading up to 0.75 amps, while B is the filament accumulator of suitable voltage for the valve employed.

$L_4$  is the radio-frequency choke serving the same purpose as  $L_2$  and  $L_3$ , the constructional difference being that it is only required to carry the anode current of the valve and may consist of No. 36 S.W.G. wire.

$A_2$  is a milliammeter of suitable range for the anode current of the valve employed, a convenient value being 0-15 mA.

If, then, the filament current is fixed at a known value, and the high-frequency alternating current which is generated in the aerial-counterpoise system is passed through the heated filament, an increase of temperature will take place.

### The Filament Characteristic.

If, now, with everything in place, as in Fig. 1, a curve is plotted showing filament current against emission, a curve similar to Fig. 2 will be the result. It should be noted that in the case of the particular valve

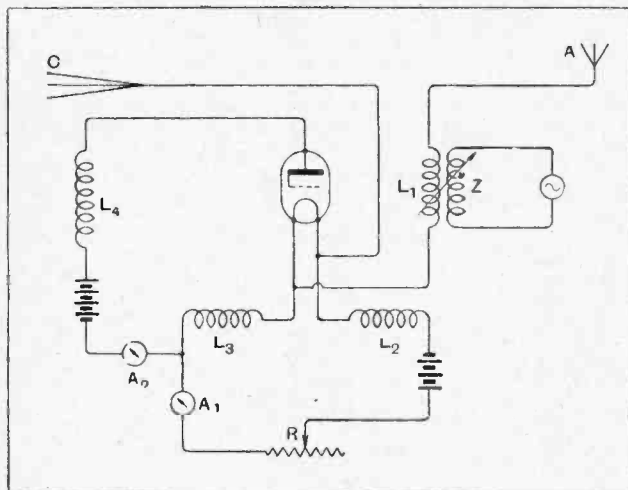

Fig. 1.—Circuit diagram of thermionic ammeter connected in aerial system of low-power transmitter.

If a filament of this description is supplied with a biasing current—that is, if a certain value of current is passed through it—then the increase of anode current due to any extra heating of the filament will bear a fairly definite ratio to the amount of such extra current which may pass through the filament, provided that both anode and grid are at a constant potential with respect to the filament and are also in close proximity to the emitting surface.

**Thermionic Aerial Ammeter.—**

A.C.1 with which this curve was made, the really useful portion of the curve starts when the filament current is 0.425 amps, giving a corresponding emission of 3 milliamps, up to a filament current of 0.5 amps with corresponding anode current of 15 milliamps. This may be regarded as more or less straight. To use the device it

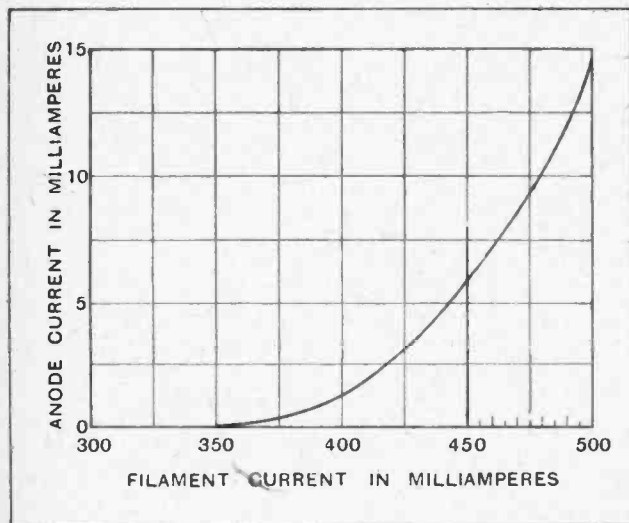

Fig. 2.—Filament characteristic of the A.C.1 valve

is only necessary to draw a line at right angles to the filament current ordinate at some convenient point, say, 450 milliamps, when we see that the anode current of 6 milliamps will flow.

The key to the transmitter is now pressed, causing a small current to be induced in the aerial which has to pass through the filament, thus causing some heating effect.

We will say, for the sake of argument, that 5 milliamps current are passed through the filament. This results in an increase of from 6 to 6½ milliamps. Conversely, if the aerial current be unknown, we will assume that the anode current rises from 6 to 9 milliamps. On looking at the point of intersection on the curve we find that an increase of 23 milliamps has taken place in order to produce this extra emission. Therefore we are safe in assuming that the value of the anode current is 23 milliamps.

Entire originality is not claimed for this method of measuring these currents, but it is suggested that the method is probably known to few people, and will, therefore, be of great use in the low-power tests which are now taking place under the auspices of the T. and R. section of the Radio Society of Great Britain.

**Advantages over Thermoammeters.**

The arrangement shows three distinct advantages over the usual method of multi-junction thermocouple instruments:—

1. It is cheap.
2. The resistance of this filament is in the neighbourhood of 2 ohms as compared with 12-14 ohms in the case of the thermocouple instruments.

3. The thermocouple instruments can usually be supplied only in the current-squared calibration, whereas the instrument above described can be calibrated for direct reading.

As a last point, the best and most sensitive arrangements depend upon a low filament resistance, and the author has found that the A.C.1 Mullard valve is particularly suitable in these measurements. These are available from Messrs. The Mullard Radio Valve Co., Ltd., price 30s.

**WIRELESS IN THE DESERT.**

SITUATED between Damascus and Baghdad, this station is 150 miles from the nearest habitation. The building is the recently erected Police Post at Rutbah, which also serves as a rest house and depot for the desert motor transport and mail services.

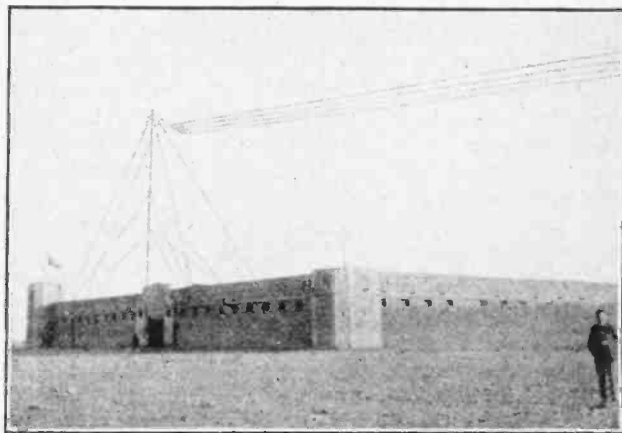

The Iraq Government Wireless Station at Rutbah.

It is understood that the station will be largely used in connection with the projected Imperial Airways Mail Service to India.

The station commenced working on September 11th, and operates on a wavelength of 850 metres, the call sign being RTB.

**"Let Your Friends Listen"** during National Wireless Week, November 7th to 13th, and having listened tell them that a Buyer's Guide to Complete Sets will be included in *The Wireless World* of November 10th, so that if they prefer to buy rather than make a set they will find the information to assist them in their choice contained in that issue.

**Our Buyer's Guide**, which was included in an issue early this year, was regarded as such a valuable innovation that we have decided to repeat it, and have chosen National Wireless Week as an opportune moment for its appearance.



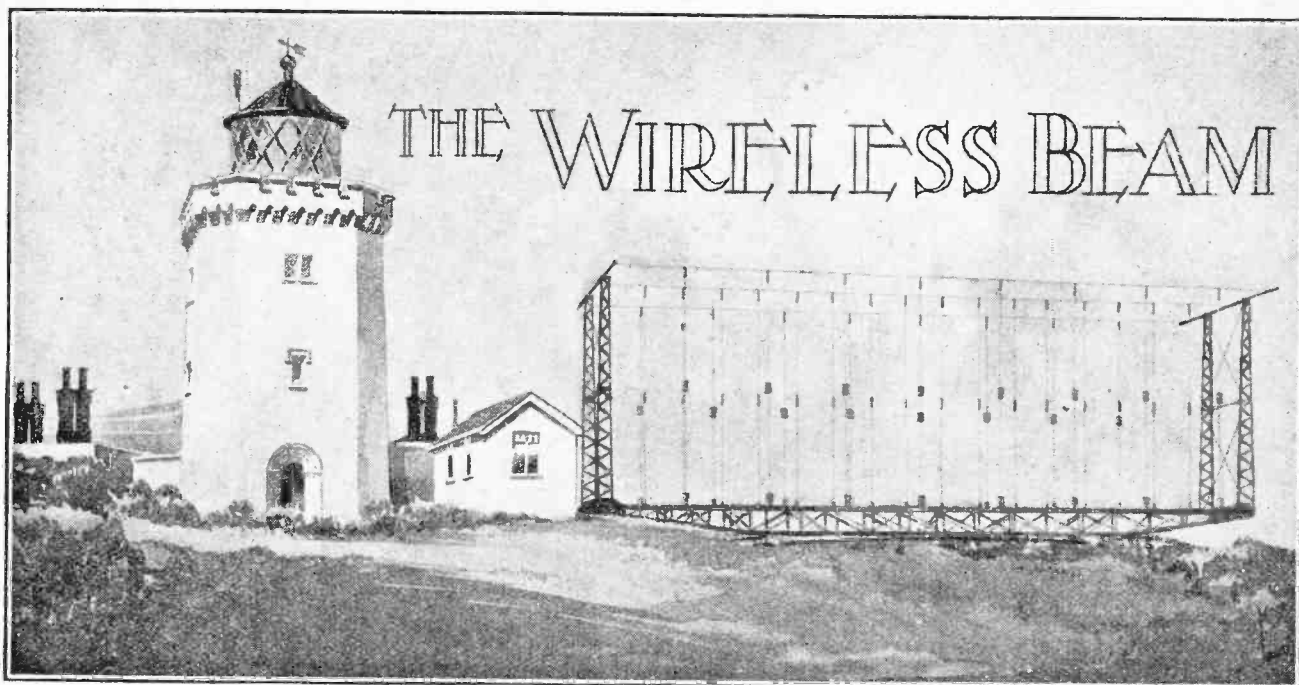

## A Description of the "Canadian" and "South African" Short-wave Transmitters at Bodmin, Cornwall.

THE Bodmin transmitting station is built upon a strip of land, partly downland and partly farmland, bordering the main Bodmin-Truro road, four and a half miles south-west of the town from which the station takes its name.

The main buildings, which are steel-framed with concrete walls, are divided into three sections: (1) the power house, battery room, and offices; (2) the transmitter room; and (3) the absorber house. The largest building, containing the power house and offices, is connected with the transmitter room by a short covered passage, and the absorber house stands in the angle made by these two buildings.

### Power Supply.

The main power supply is provided by three Ruston and Hornsby three-cylinder vertical four-cycle, solid injection, heavy oil, cold-starting engines, each giving 165 brake-horse-power at 300 revolutions per minute. Each of the engines is directly coupled by a flexible coupling to a 92-kilowatt compound-wound dynamo, by Newtons, of Taunton, delivering direct current to the main switch-board at 440 volts. These generators can be run singly or in parallel as required.

The following auxiliary generators, driven in each case by 440-volt D.C. motors, supply power for the various circuits:—

Three "main power" alternators, by the Lancashire Dynamo Company, each having an output of 50 KVA single-phase A.C. at 1,000 volts 300 cycles.

Three "drive power" alternators, by the Electric Construction Company, each having an output of 1.2 KVA single-phase at 220 volts 500 cycles.

Two "rectifier filament" alternators, by the Lancashire Dynamo Company, each having an output of 20 KVA single-phase A.C. at 500 volts 300 cycles, for heating the filaments of the main and drive rectifying valves at 11 to 12 volts through step-down transformers.

Two "magnifier filament" generators, by Newton's, of Taunton, each having an output of 18 kW. direct current at 24 volts.

Two oil engines and 440-volt generators, paralleled, will carry the full load of the two transmitters quite comfortably, leaving one in reserve.

### Rectifiers.

Two sets of valve rectifiers are used to provide the high-tension D.C. anode supplies for each of the valve transmitters. There is one main rectifier and one drive rectifier for each set. Each main rectifier carries a bank of sixteen Marconi MR7a valves, and each drive rectifier is a self-contained unit carrying two Marconi MR7a valves and condensers.

### Transmitters.

The "drive," or master oscillator, which is the most important unit for maintaining constancy of wavelength, is entirely screened from the rest of the circuits. The transmitter is controlled by the "drive," which maintains the intermediate and main oscillatory circuits on the "drive" frequency.

The oscillatory circuit of the "drive" or master oscillator is coupled to another oscillatory circuit known as No. 3 magnifier. This is in part an amplifying circuit, and in part a stabilising circuit, which, by acting as a buffer between the drive and power circuits proper,

**The Wireless Beam.—**

helps to maintain the constancy of the drive wavelength when keying. As in the case of the drive, the No. 3 magnifier is completely screened. No. 3 magnifier is coupled to still another oscillatory circuit known as No. 2 magnifier, which, in turn, is coupled to the grid circuits of No. 1 magnifier, the main power oscillator of the transmitter, in which oil-cooled valves are employed.

Oil-cooling for the valve anodes is used in the main power circuits in preference to water-cooling, because in short-wave work valve capacity and resistance losses must be reduced to a minimum, and this is obtained more effectively with an oil than a water-circulating system, as oil is in itself a good insulator.

The transmitter may consist of three or four panels, according to whether one or two distinct wavelengths are to be used. In the stations now being erected for communication between Great Britain and the Dominions two wavelengths may be used, and each transmitter has four panels.

Starting from the left, Panel A contains No. 1 magnifier, or the power oscillator, and the H.F. coupling circuit to the feeders, which convey the H.F. energy to the aerials. The valves used are two Marconi type CAT2

oil-cooled valves. The filament, grid, and anode seals are cooled by air blast. The high-tension D.C. anode supply is available at approximately 8,000 to 10,000 volts, and the grid negative biasing voltage when working is approximately 400. During normal working on test the total anode input to the two valves has been approximately 18 kilowatts at a feed of 1.1 amp. per valve. The high-frequency circuits of this panel can be changed quickly from the shorter to the longer wavelength, or *vice versa*.

Panel B contains No. 2 magnifier in the upper half. This magnifier supplies power to the grids of No. 1 magnifier. It has two Marconi MT9F air-cooled valves with a filament voltage of approximately 19 and a current of  $12\frac{1}{2}$  amps. per valve. The anode supply to these valves is taken from the 10,000 v. D.C. main *via* the absorbing resistances and also certain breaking down resistances. In the "marking" condition the high-tension anode voltage is about 5,000 and the feed 150 milliamps. In the "spacing" condition these valves oscillate so weakly that No. 1 magnifier fails to oscillate at all. The magnifier grid negative biasing voltage when the set is working is approximately 300.

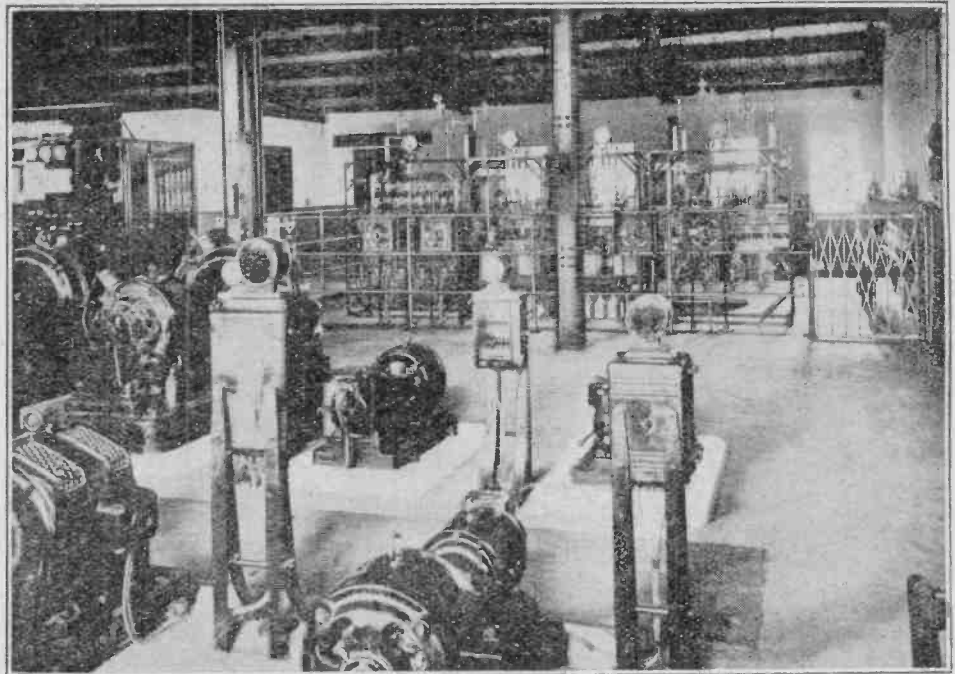

Fig. 1.—A corner of the power house showing rectifier panels in the background.

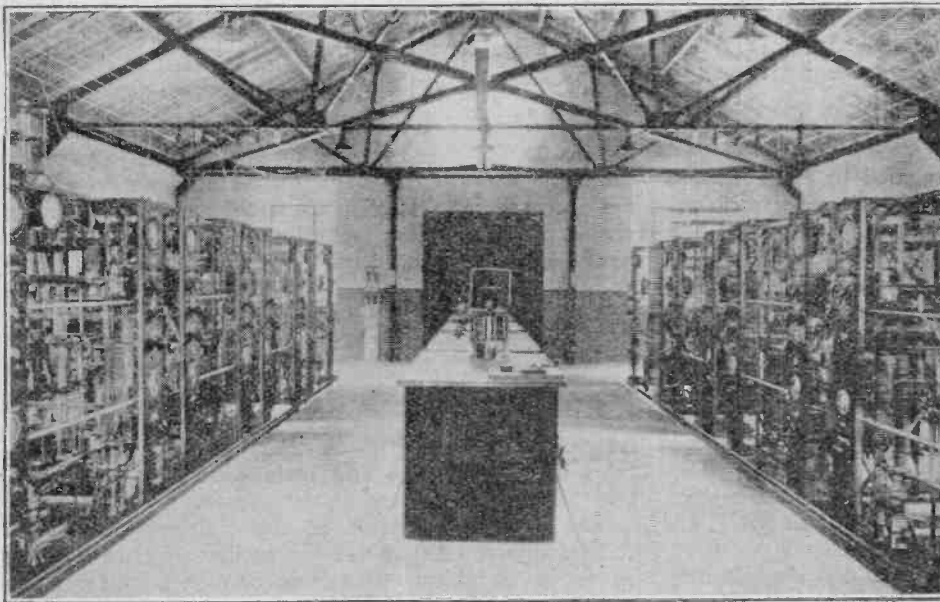

Fig. 2.—General view of the transmitter room.

**The Wireless Beam.—**

The filaments are supplied from the same motor generator as for Panel A. The No. 3 magnifier occupies the left-hand compartment of the screening box in Panel B, and drives the grids of No. 2 magnifier. The H.F. circuit is the same as in No. 1 and No. 2 magnifiers, except that one valve is replaced by a condenser. The valve is a Marconi MT10 air-cooled valve, which takes 7.5 amps. filament current and requires a voltage of approximately 12.5. The normal high-tension supply is 1,900 or 2,000 volts, and the feed about 80 to 90 milliamps. The drive, which occupies the lower right-hand compartment of the screening box in this panel, has the same high-tension and filament lighting supply as for No. 3 magnifier, the anode voltage and feed current being approximately the same as that of

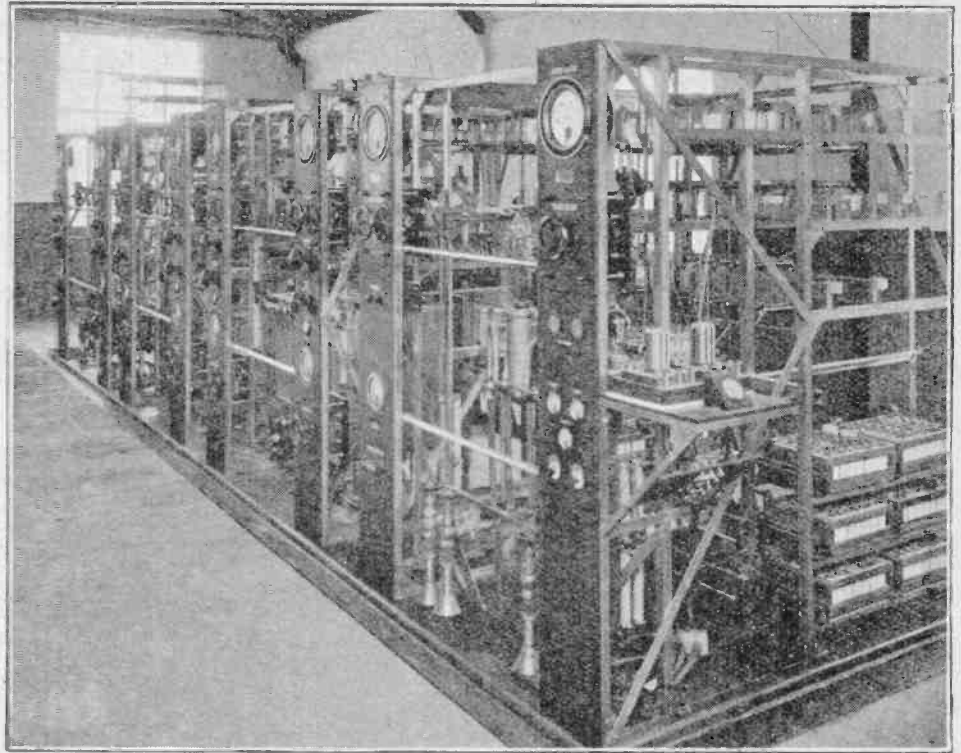

Fig. 3.—The Canadian beam transmitter.

No. 3 magnifier. The valve is an air-cooled MT10, as in No. 3 magnifier, and the circuit, which is self-oscillating, drives the grid circuit of No. 3 magnifier.

Panel C is identical with Panel B, except that it is designed for working on a different wavelength.

Panel D contains the main and sub-absorbing and keying circuits which divert the high-tension supply by means of two Marconi type CAM2 oil-cooled valves in parallel, through resistances during the spacing periods, and so keep a constant load on the generators. Simultaneously with the shunting of the supply through the absorbing circuits, the voltage on No. 2 magnifier anodes is dropped to about 600. The keying current from the high-speed signalling relay fitted on this panel is stepped up to the grids of the CAM2 valves through two Marconi type DET1 valves in parallel. The CAM2 valves take a filament current of 25 amps. at 18 volts.

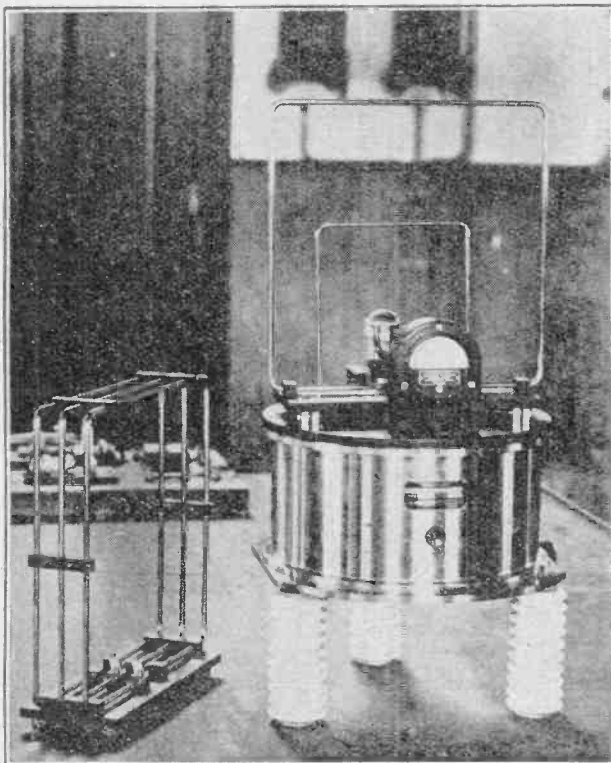

Fig. 4.—Standard wavemeter for checking transmitted wave.

A 41

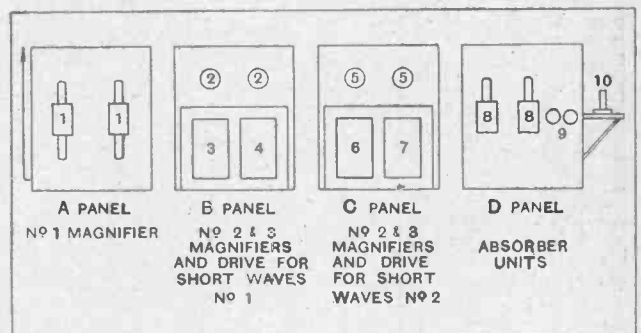

Fig. 5.—Schematic diagram showing layout of transmitter panel.

**The Wireless Beam.—**

The transmitter is operated through an A.T.M. relay to which is connected an adjustable condenser and adjustable resistance for balancing purposes, a spare relay being also provided to which connection can be made by means of a change-over switch.

Each transmitter is mounted on a concrete raft floated on Coresil cork pads to prevent mechanical vibration being transmitted to the high-frequency circuits and valves on the panels.

**Keying.**

The method of keying is so arranged as to keep the load on the power supply constant. During "marking" the high-tension power is thrown on to the main magnifiers, but during spacing the power is shunted through an equivalent load by means of the panel containing the absorbing valves and resistances. These valves are made conductive or non-conductive as their grids are thrown positive or negative by the keying relays, the effects of which are stepped up through a small circuit known as the sub-absorber directly influenced in its turn by a low-current land line relay. In their conducting state the energy is mainly absorbed by the mat resistances which are contained in the absorber house, the small building near the transmitting room. This method of keying has the great advantage that there is only one small relay between the land line and the transmitter, which means only one small mechanical motion. The land line controlling apparatus and a beat note amplifier and loud-speaker for checking outgoing signals are mounted on a separate table.

**Call Letters and Wavelengths.**

The Canadian transmitter at the Bodmin Station is arranged for transmission of signals to Canada on just over 26 metres, which was the wavelength used during the official test. As an alternative, the transmitter has

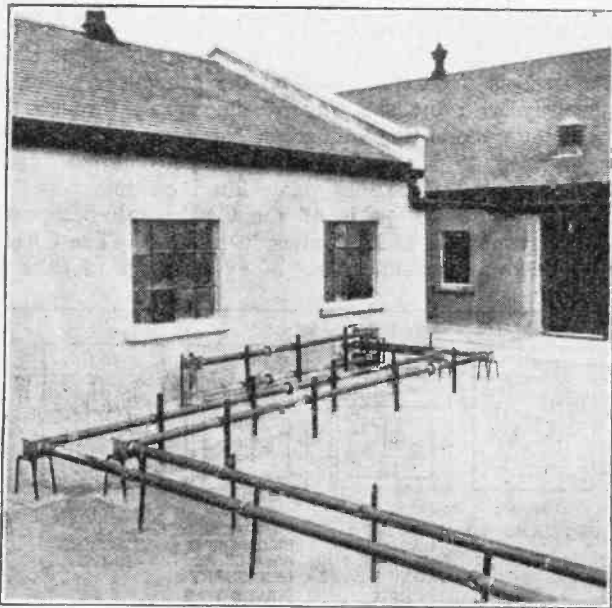

Fig. 6.—Exterior of transmitter house showing feeders to "South African" aerial system.

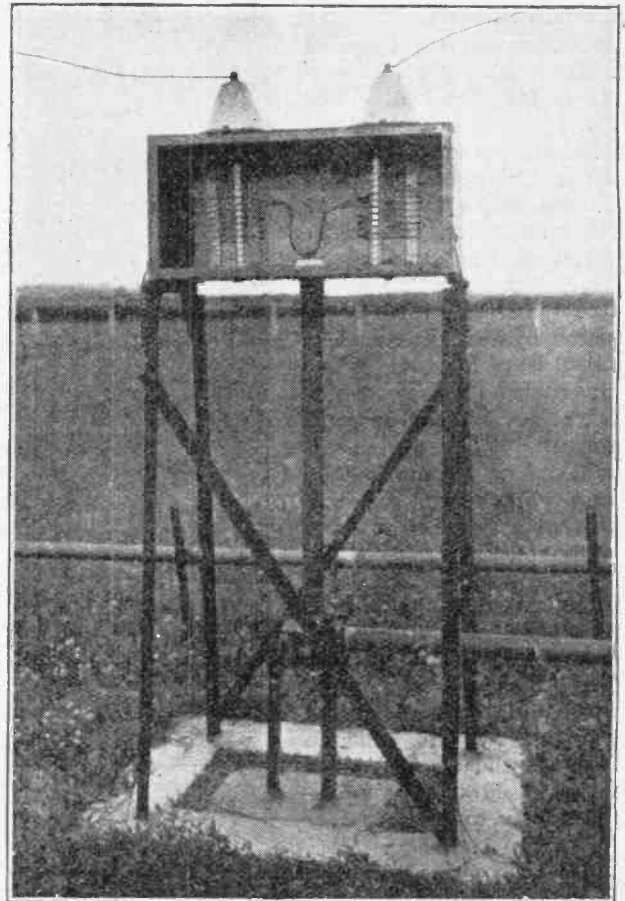

Fig. 7.—Interior view of aerial coupling box with side removed showing balancing coils.

been arranged to be able to work on a second wavelength from the other aerial bay. The call letters of the England-Canada service are GBK.

**Feeder System.**

Very careful attention has been paid to the design and construction of the feeder system through which the aerials are fed with high-frequency current from the transmitter house. The feeder must be air-insulated to avoid loss, and for this purpose it is made of two concentric copper tubes. The outer tube is earthed and carried on iron standards driven into the ground. The inner tube is insulated from the outer tube by porcelain spacing insulators. This arrangement ensures the feeder being both mechanically and electrically symmetrical within fine limits throughout its length.

The length of feeder tube from the transmitter to each individual aerial wire of that particular aerial system is exactly the same. Two feeders for each service, *i.e.*, Canada and South Africa,—one for each wave band—run from the transmitter building along the front of the aerial system at about one hundred feet from the centre line of the masts. As there are five masts for each service, forming four bays, two of which are allocated to the aerial system for each wave band, one feeder runs from the feeder ammeter box in the transmitter room to the centre point of each pair of bays. At this point



**The Wireless Beam.—**

there is a junction box which divides into two branches, one going to the centre of each bay. Here there is another junction box, and the feeder is again divided equally and branched as before, the process being continued until there is one branch for each pair of aerial wires. At this point there is an aerial coupling box in which the feeder is again split up, so that there is an individual feed to each aerial wire. It is arranged that a transformer may be placed in each feeder junction box to assist in balancing the feeder system so as to ensure the equal distribution and correct phase relation of the currents to each aerial wire. In addition to these coils, condenser tubes, consisting of short lengths of feeder tubing, may be fitted at the coupling boxes for the same purpose.

In each aerial coupling box (see Fig. 7) there are two coils, mounted on porcelain insulators. Both coils are connected at the bottom to the casing of the box, which is earthed, and tapings from the feeder tube and aeri- als are connected to suitable points on each coil which then act as auto-transformers. The lead-in from each aerial is brought through a porcelain insulator at the top of the box. These coils may also be employed as series inductance if required. It should be noted that the aeri- als and feeders are so adjusted that the sum of the system acts as a pure resistance load on the transmitter so that there is no reflected wave up and down the feeder system.

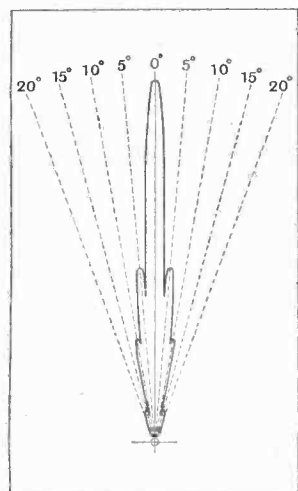

Fig. 9.—Polar curve of beam aerial at Bodmin, taken at 6217 ft. radius with two bays working on 26.086 metres.

of something having gone out of adjustment, are immediately indicated by different readings on the three ammeters. By keeping a watch on these ammeters the correctness of the adjustment of the whole feeder system can be observed and maintained.

**Masts and Aerials.**

The layout of each row of five masts is arranged so that the great circle bearing on the distant station with

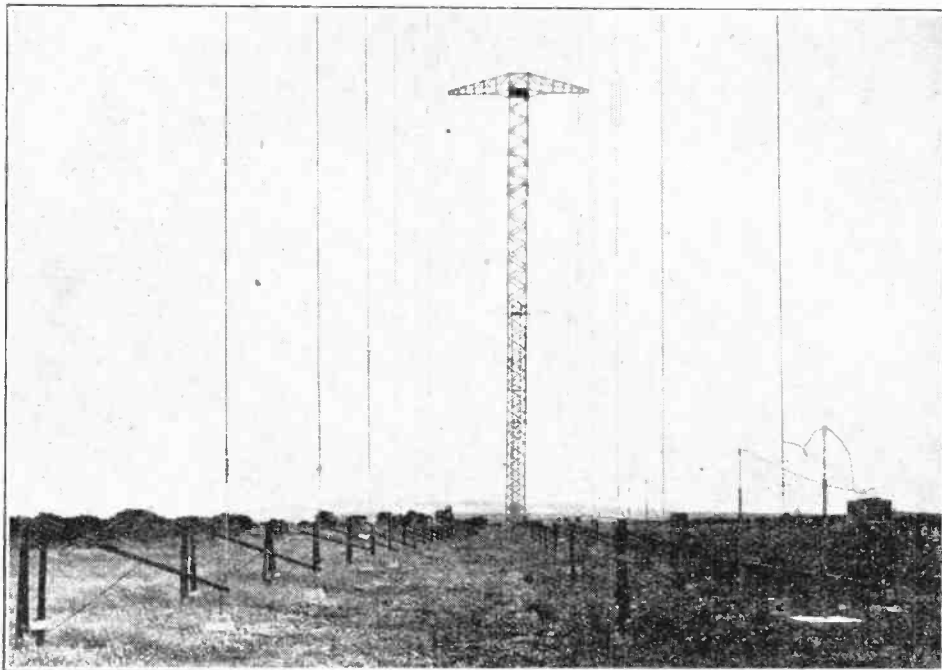

Fig. 8.—Canadian transmitter aerial system showing balance weights. The aerial wires are on the right and reflectors on the left.

At the point where the feeder system for each service leaves the transmitter house there is an ammeter box containing a change-over link which can be connected to either feeder. On the internal side of the link two loops of feeder tube are so arranged that three high-frequency thermoammeters come into proximity although actually situated equally at distances of 32 feet apart along the feeder. Any reflected waves in the feeder system, as the result

which that particular system is designed to communicate is at right angles to the line of masts. As the beam leaves the aerial system at right angles to the plane of the masts and necessarily follows the shortest, or great-circle track, the distant station must be in the centre of the beam, and will therefore receive the maximum strength of signals. The exact orientation is as follows:—Canadian line of masts, 157° 52in. W. of true North; South African line of masts, 70° 47in. E. of true North

The details of aerial construction have a definite relation to the wavelength used. In the case of Bodmin there are two different wavelengths to be radiated. The one now in operation is 11,500 kilocycles, approximately 26 metres; the other is not yet fixed. The aerial used for the 26 metres wavelength occupies two bays. With this wavelength there are 32 aerial wires in all, 16 in each bay, and 64 reflecting wires.

Each short-wave aerial wire consists of three sections linked by inductances, or phasing coils, the whole unit being attached, top and bottom, by means of insulators fitted with corona rings. The short-wave reflector wire consists of five lengths of wire separated by insulators between each section.

The design of the aerial and reflector system is identical at both the transmitting and receiving stations.





# Broadcast Brevities

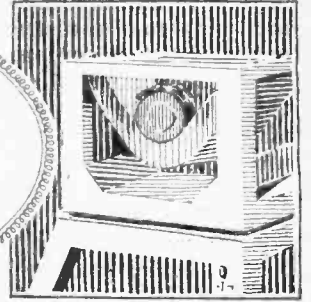

News from All Quarters: By Our Special Correspondent.

## Date of Geneva Scheme—The New Commission—Waiting for the Charter—Oscillators' Night.

### The Great Shuffle.

From a reliable source I hear that the wavelength changes under the Geneva scheme may be expected to occur on or about Sunday, November 14th.

o o o o

### The Commission.

What is going to happen to British Broadcasting? The Postmaster General has at last divulged information, which had already leaked out, concerning appointments to the Broadcasting Commission. The new board will consist of:

- The Earl of Clarendon (chairman).
- Lord Gainford (vice-chairman).
- Sir Gordon Nairne, Bart.
- Dr. Montague Rendall.
- Mrs. Philip Snowden.

These members will be known as Governors of the British Broadcasting Commission, while Mr. J. C. W. Reith, the present managing director of the B.B.C., will be appointed Director-General.

o o o o

### Who's Who.

Lord Clarendon, whose age is 49, is an Under-Secretary of State for Foreign Affairs, while Lord Gainford, the only governor whose name has been associated with broadcasting since its early days, is chairman of the County of London Electricity Supply Co. Mrs. Philip Snowden is well known, not only as the wife of a former Chancellor of the Exchequer, but as a prominent worker in the feminist cause, and an advocate of temperance. Dr. Montague Rendall was headmaster of Winchester School from 1911 to 1924, and Sir Gordon Nairne is a director and late comptroller of the Bank of England.

o o o o

### Waiting for the Charter.

This is all fairly interesting, but I do not think that the appointment of such a board means that we can fold our arms and shut our eyes in the sure and certain hope that "all will be well." We must first see the charter.

o o o o

### Pertinent Questions.

Will the charter retain the licence fee at 10s.? Will it place any limit on the revenue of the corporation in the same

manner as the P.M.G. has circumscribed the activities of the Broadcasting Company?

Will the new Corporation be granted any freedom respecting alterations in wavelength and power, the erection of new stations, or the closing of existing ones?

Will the coming charter make it a condition that any scheme respecting a "Wireless University" will be conducted independently of the normal programmes, and that such a scheme will hurry the development of the regional stations about which we heard so much a little while ago?

o o o o

### The Regional Scheme.

These are just a few of the questions which await answers. With regard to the first query, I hear that any change in the licence fee is extremely improbable. As for the regional stations, we shall be lucky, I think, if they are in operation before Christmas, 1928.

### A Thought for the Week.

The British Broadcasting Company seems to spend its declining years in declining to spend.

o o o o

### Cutting Costs.

Despite the complaints of several well-known artists that the B.B.C. is offering paltry fees, certain rumours ought to be contradicted. There is no truth, for instance, in the base assertion that fees will shortly be suspended, and that, as a substitute, the B.B.C. will offer free cups of hot coffee.

"Morphia would be better," a learned doctor is said to have remarked.

o o o o

### Broadcasting in Denmark.

Attempts are being made to broadcast the Copenhagen programmes in Denmark and Sweden. During the past month the performances from the Royal Opera House at Copenhagen as well as from the Opera House at Stockholm, have been simultaneously broadcast from all the Danish and

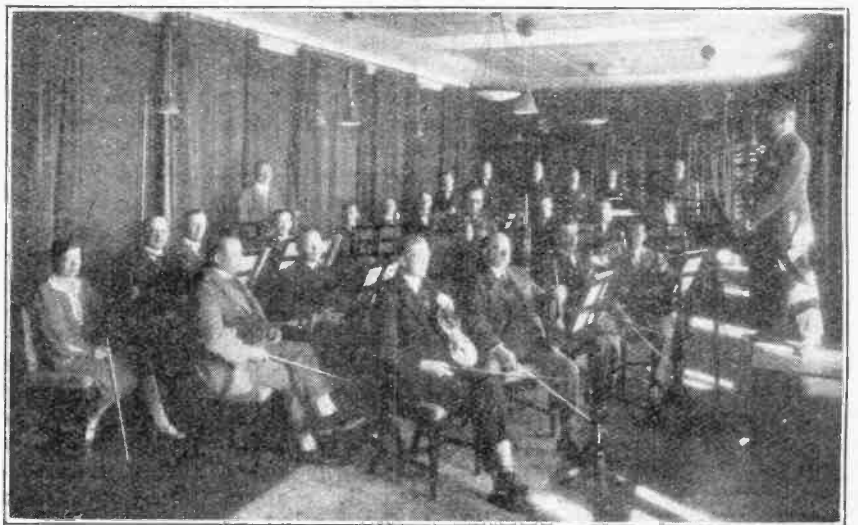

DENMARK'S NEW STATION. A view in the studio at Copenhagen, showing the station orchestra. Arrangements have been made for the simultaneous broadcasting of certain Copenhagen programmes throughout Denmark and Sweden.

Swedish stations. The broadcasting authorities of the three Scandinavian countries have some ambitious plans in view for interlay work during the coming winter.

o o o o

#### A George Grossmith Programme.

"My Programme," prepared by Mr. George Grossmith, is to be one of 2LO's features in a few weeks' time.

o o o o

#### "Let Your Friends Listen."

The number of receiving licences now issued is 2,105,000. It seems a little doubtful whether the 2½ million mark will be reached this year, though there is no knowing what National Wireless Week will accomplish. "Let your friends listen"—and bring the figure to three million!

o o o o

#### Dilemma in South London.

"All is not static that twitters," Shakespeare might say if he were writing a modern drama with scenes laid in Coulsdon, Norbury, Hayes and other backwoods of South London.

Residents in these districts are complaining bitterly of atmospherics, but as the trouble appears to be practically absent in other parts, we can make the deduction that atmospherics are not responsible. What seems probable is that the cause is the newly electrified portion of the Southern Railway, with its overhead conduit system. To ask the railway company to shield their track might cause still further disturbance by the creation of an electrical atmosphere in the S.R. board room. So what can South London do about it?

o o o o

#### "My Programme."

Among the prominent people whose names have been mentioned in connection with the "My Programme" series, for which *The Man in the Street* and Mr. Pat Hendren have already provided broadcasts, are Mr. Bernard Shaw and Mr. J. L. Garvin. A programme by a woman will also be arranged.

o o o o

#### Germ Barrage at 2LO.

Visitors to Savoy Hill should be prepared for shocks. At the present moment anybody may be subject to a gas attack without warning.

Entering the building last week, I found myself confronted by a youth who had sprung from nowhere, brandishing a disinfectant spray. Recovering from the effects of the inoculation, I ascended in the lift, to receive another dose of disinfectant as I alighted. This sort of anti-germ barrage goes on all day, because, I hear, an epidemic of influenza is threatened. It seems a pity that the spray cannot be broadcast.

o o o o

#### Famous Pianist at Belfast.

Laffitte, the well-known pianist, is to visit Belfast this evening for the first time. He will play the Cesar Franck Symphonic Variations.

#### Fireworks?

The variety programme on Friday next is to have a Guy Fawkes flavour.

o o o o

#### Oscillators' Night.

Saturday is to be "Oscillators' Night" this winter. Whisht! Do not misunderstand me. Remove your hand from that coil holder. Thank you.

#### FUTURE FEATURES.

##### Sunday, November 7th.

LONDON.—Special relay of Huguenot Service from Crypt of Canterbury Cathedral; Star Ballad Concert.

BIRMINGHAM.—First Concert of Beethoven Centenary Series.

NEWCASTLE.—Symphony Concert.

##### Monday, November 8th.

LONDON.—All British Programme by Massed Military Bands.

GLASGOW.—Scottish Towns Series—Motherwell Programme.

EDINBURGH.—Station Pianoforte Quartet.

##### Tuesday, November 9th.

LONDON.—Variety Programme.

MANCHESTER.—Tuesday Mid-day Society's Concert from Houldsworth Hall.

BELFAST.—Variety Programme.

##### Wednesday, November 10th.

LONDON.—Chambers Chamber Orchestra.

BOURNEMOUTH.—Wynne Ajello (soprano); Walter Glynn (tenor).

MANCHESTER.—Besses o' th' Barn Band.

##### Thursday, November 11th.

LONDON.—Armistice Day Service from Canterbury Cathedral.

CARDIFF.—War Memorial Service from the Cenotaph.

MANCHESTER.—Armistice Day Service and Ceremony relayed from Albert Square.

NEWCASTLE.—Armistice Day Service relayed from Newcastle Cathedral.

GLASGOW.—Armistice Ceremony relayed from the Cenotaph, George Square.

ABERDEEN.—Armistice Day Service relayed from West U.F. Church.

BELFAST.—Armistice Day Service relayed from the City Hall Grounds.

##### Friday, November 12th.

LONDON.—"The Yellow Jacket," Chinese Play in three acts.

GLASGOW.—Post Armistice Songs.

BELFAST.—Concert by Belfast Philharmonic Society.

##### Saturday, November 13th.

LONDON.—Star Revue by Graham John.

MANCHESTER.—Grand Orchestral Concert.

DUNDEE.—"The Glass Panel," one-act play by Arthur Black.

Every Saturday night the B.B.C. will broadcast a tactful little announcement drawing attention to those districts which are feeling the effects of oscillation. Fatherly cautions will be administered together with a little sound advice.

Very wisely the B.B.C. has decided that six complaints must be received from any one locality before it can enjoy the distinction of being named.

o o o o

#### Comfort for Comedians.

What percentage of the total number of broadcast receivers are actually in use on a normal evening? This question is raised not by battery manufacturers but by several music-hall comedians who contend that payment for broadcast "turns" should be proportionate to the size of the audience.

The B.B.C. is beginning to recognise that a comedian who scatters all his brightest gems to the listening world is spoiling his chances of securing audiences in the theatres he may subsequently visit. Period contracts are now being signed whereby comedians will be able to tour the provincial stations one at a time, instead of by "S.B.," with a corresponding increase in their fee covering a period of a week or more.

o o o o

#### An Impossible Census.

If entertainers persisted in the demand for fees commensurate with the size of their audience, and if such a census were possible, it would be only fair to the B.B.C. if the figures were taken towards the end of the comic "turns." But would that be fair to the comedians?

o o o o

#### A German View.

The supposed conflict between broadcasting and the entertainment industry formed the topic of some interesting remarks made recently by Herr Sachse, of Berlin, at an extraordinary general meeting of the International Music Hall Managers' Association held at Dusseldorf.

"Broadcasting," said Herr Sachse, "appeals to a much more numerous public than that which we have ever been able to gather in the total number of our establishments. Among its public there are truly masses which have never hitherto taken any interest in the stage, music-hall and cabaret shows, and which, having made the acquaintance of our productions through the intermediary of broadcasting, have been won over to us as an entirely new public."

o o o o

#### The Queen's Hall Conundrum.

The remarks of Herr Sachse are in violent contrast to those of Mr. William Boosey, who asserts that the future of the Queen's Hall as the home of classical music is jeopardised by the "subsidised concerts of the B.B.C."

It seems to me that Mr. Boosey has probably to thank broadcasting for the advent of a good many patrons whose enthusiasm for classical music is directly due to the efforts of the B.B.C.

## TRANSMITTERS' NOTES AND QUERIES

### General Notes.

Mr. A. J. Baker (G 6QH), 23, Third Avenue, Bush Hill Park, Enfield, informs us that on October 11th he altered his transmitting aerial to a single-wire down-lead 33 feet high with a single-wire counterpoise 30 feet long and 5 feet high, and, with a power of 6 watts, obtained from a hand generator to a Marconi DE4 valve. He worked the following stations, all on about 45 metres, within a period of seven days:—

LA 1A, Arctic Circle, on two evenings, R3 and R4, 1,400 miles.  
SMWR, Stockholm, R6, 900 miles.  
LIDO, Rome, R5, 900 miles.  
OFZ, Austria, R5.  
PIAE, Portugal, R4, 1,000 miles.  
FABSSR, French Algiers, R5, 1,000 miles.  
YS7XX, Yugo-Slavia, R5.  
D7MT, Copenhagen, R6, 700 miles.  
S2GO, Helsinki, R6, 1,100 metres.

Mr. K. J. Morée, chief of the Tjililin Radio, Tjimahi, Java, sends the following particulars about these stations:—  
ANB, 6,600 and 10,000 metres, 100 kW. Telefunken alternator.

ANF and AND, 30-50 metres, 3 kW. valve, Mesny-Eccles-Jordan system.

Mr. J. A. Partridge (G 2KF) sends in an interesting communication from Mr. T. H. Harris, of Ecfield, near Sydney, N.S.W., on the subject of reception of British stations in Australia. He states that signals come through best on the 30-34 metre band, where statics are seldom troublesome. On the 42-45 metre band many signals, of R4-5 strength and under, are lost owing to atmospheric. Between November and March is the best season for the reception of telephony. Mr. Harris, who listens regularly between 4 a.m. and 6 a.m., Sydney time (6.0 p.m. to 8.0 p.m. G.M.T.), says that the two wave-bands seem rather peculiar in their receptability. Sometimes he gets good signals on the 45-metre wavelength, while those on 32 metres are weak, so he advises British transmitters to try both wavelengths. He specially reports good telephony from G 2NM, G 5NJ, and G 6AH.

Incidentally, he mentions that Mr. D. B. Knock (A2NO) is constantly on the look-out for two-way communication with his old friends in Great Britain, especially by telephony, that he (Mr. Harris) has already heard 200 European amateurs since August, 1925, and that he greatly prefers the European broadcast programmes to those from the United States.

Mr. A. C. de Groot (EI PK1), Rongga, Java, is transmitting on 33 to 34 metres, using the Mesny circuit published in our issue of May, 1924, and has been in two-

way communication with many stations in Australia, New Zealand, U.S.A., Japan, and would like to get into touch with British amateurs.

### Reception of American Broadcasting.

We are able to give below an illustration of the receiver used by Mr. A. E. Davis, which is the Reinartz set recently described in *The Wireless World*, but modified by making interchangeable coils, adding a potentiometer and two stages of L.F., making, he says, "as good a three-valve set as I have ever handled." He also reports the reception of U 2XAD on September 27th and 28th and October 1st, 4th, 5th, 8th, 11th and 12th, the transmissions being from 1 to 5 p.m., Eastern standard time, on Mondays, Thursdays, and Fridays. One was exactly the description of a baseball match in which the cheering of the crowd could be plainly heard.

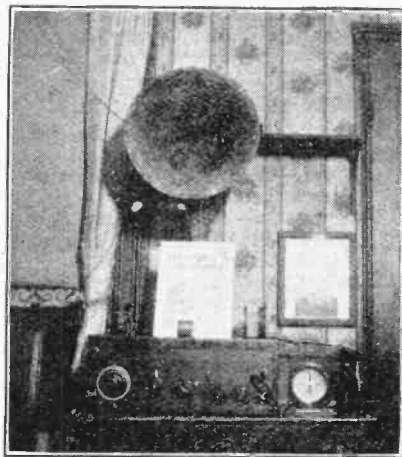

The three-valve receiver with which Mr. A. E. Davis heard U 2XAD at Oxford, as recorded above.

A correspondent from Shrewsbury has followed the working of U 2XAF for many months since it was operating from above 40 metres down to its present wavelength of 32.79 metres. Reception is carried out on 0-v-1 for headphones with one additional L.F. stage for loud-speaker, the aerial being 35 feet span flat top inverted L, 35 feet high, and earth to a waterpipe. During the past summer he has heard the station at times when three-quarters or more of the distance would have been in full daylight. He gives the following list of

stations heard:—October 4th, U 2XAD, on 26.8 metres, 8.50-10 p.m., G.M.T.; October 9th, U 2XAF, on 32.79 metres, 11.25-12.30 p.m., G.M.T.; October 12th, U 2XAD, 9.35-10 p.m., and U 2XAF, 11.15 p.m.-12.30 a.m., G.M.T.

Another correspondent, in Keut, finds that transmission on 22 and 26 metres from U 2XAE gets weaker as darkness increases over the Atlantic, in contrast to U 2XAF, which becomes much stronger. During the past month he has generally had no difficulty in getting 2XAF on the loud-speaker with three valves.

U 2XAF sends out a complete schedule of the week's work at 23.40 G.M.T. on Saturdays (in Morse), and usually transmits the WGY programme from 23.30 G.M.T. His experimental transmissions from 19.00 to 22.00 G.M.T. are irregular.

### New Call-signs Allotted and Stations Identified.

- D 7XU H. Norgaard, 33, Livjærgsgade, Copenhagen.  
D 7ZG H. T. Petersen, "Fribro," Østergade, Nørresundby, Denmark.  
EAR 26 E. Estalella, Avenue del Puerto 66, Valencia.  
EAR 28 J. B. Novo, Patio de Madres 13, Santiago.  
G 2AO O. H. Rely, "Gavinwood," Willingden Rd. Eastbourne. Transmits on 23 and 45 metres. (Change of address.)  
G 2AOZ (Art. A.) (Ex 615). P. R. Solder, 76, Albert Rd., Alexandra Park, N.J.I.  
G 2BDI (Art. A.) T. E. G. Black, 2a, Watson's Road, South Shore, Blackpool (change of address).  
G 2BTL (Ex 5WH) A. J. Goodwin, Scotswood, Hale Lane, Mill Hill, N. 7.  
G 2BYN H. D. Price, 12, Hillcrest Rd., Sydenham, S.E.26.  
G 2BZC (Art. A.) M. W. Pålpe, 38, Purley Ave., Cricklewood, N.W.2. (Change of address.)  
G 2BZH (Ex 5SQ.) A. P. McGroarty, 58, Kirk St., Campbelltown, N.B.  
G 2GF P. E. A. Griffiths, 12, Glencoe Mansions, Chapel St., Brixton, S.W.9. Transmits on 23, 45 and 90 metres.  
G 5AA W. A. Read, Westmead, Ashurst Rd., North Finchley. (Replacing G 5XH, now held by L. W. Hooke, Balham, S.W.12.)  
G 5BI Birchall Bros., 35, Bradshawgate, Leigh, Lancs. Transmits on 45 metres.  
G 5OK (Ex 2AYP) W. J. Coyle, 134, London Road, Southend-on-Sea. Transmits on 150-200 metres.  
G 5UD W. Driver, 3, The Crescent, Walthamstow, Transmits on 23 and 45 metres.  
G 5WH W. D. Horuman, Virginia Water Cottage, Sunninghill, Berks.  
G 6FZ H. E. P. Taylor, Warkworth, Onslow Crescent, Woking (change of address).  
G 6QW (Ex 2AZP) W. B. Weber, 2, Balmoral Rd., St. Andrews, Bristol. Transmits on 8 to 440 metres.  
G 6RO (Portable) O. H. Rely, 29, Ocklynge Rd., Eastbourne.  
G 6WA E. M. Withers, "Greycoke," Winchester Road, Basingstoke, Transmits on 45 metres.  
G 6YA Bradford-on-Avon District Radio Society.  
GI2AFD (Art. A.) R. S. Holden, 110, Glenwood St., Belfast.  
GW 14C D. G. Kennedy, 21, Morehampton Rd., Dublin.  
I 1RG Ernesto Montu, Viale Bianca Maria 24, Milan. (Change of address.)  
LA 1E Lorentz Johnson, Vårvaslingen paa Vestlandet, Bergen.  
LIT 1B W. Hlentalis, Aukst, Karin, Kursai, Kaunas, Lithuania.  
R 2WP W. N. Paramonow, Neglimmy pr. 14, Moscow.

# NEWS FROM THE CLUBS.

Secretaries of Local Clubs are invited to send in for publication club news of general interest. All photographs published will be paid for.

## Open Night at Bristol.

Mr. Oswald Carpenter gave an interesting impromptu talk on various wireless topics at the Bristol and District Radio Society's meeting on October 22nd. Among the subjects touched upon were modern microphones and cone type loud-speakers. Amusement was caused later when the weekly ballot was won by the visitor, Mr. Carpenter himself!

The society will hold an open night on November 5th, when members are invited to bring sets and components for demonstration.

Hon. secretary: Mr. S. J. Hurley, 46, Cotswold Road, Bedminster, Bristol.

## Tottenham Exhibition Triumph.

Over sixteen hundred people attended the Tottenham Wireless Society's Exhibition and Demonstration, which was held on Thursday, October 21st, and proved a tremendous success. Owing to the huge crowd a great many persons were unable to take advantage of services offered by the test stands, and the committee are arranging for an ordinary meeting night to be set aside for this purpose in the near future.

The exhibition was formally opened with an interesting speech by Prof. A. M. Low, who subsequently gave a fascinating demonstration of the audio-meter.

Numerous visitors were supplied with membership application forms, and several new members were enlisted.

Some noteworthy points concerning the history of this live society were men-

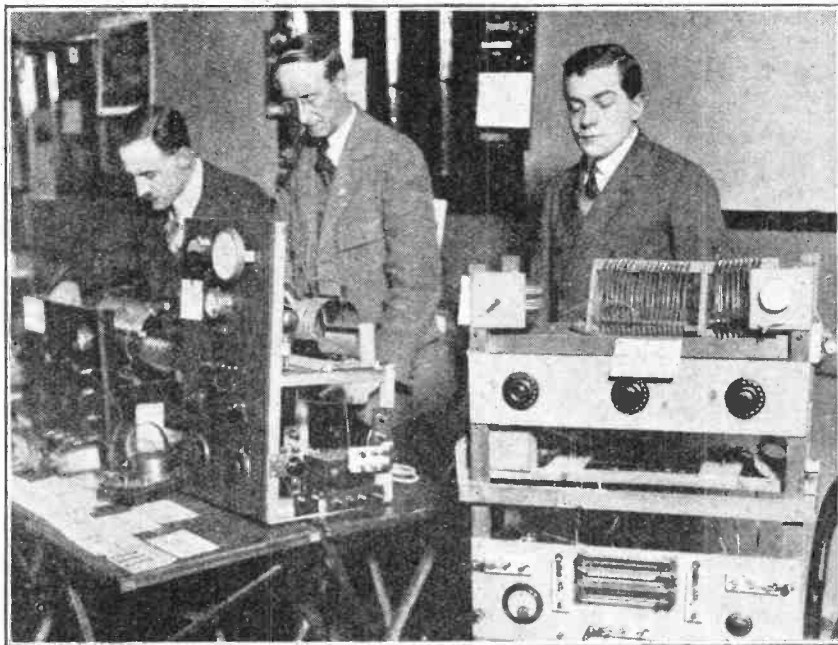

AT THE TOTTENHAM SHOW. Apparatus on view on the short wave transmission stand at the Tottenham Wireless Society's Exhibition. The event was a huge success, being attended by more than sixteen hundred visitors.

tioned in the exhibition programme. Founded in September, 1922, the society now possesses a varied and valuable collection of sets, measuring instruments, and components available on loan to members. Free technical advice is provided on all radio matters, and instruction is given in transmission and long distance reception. The Society maintains its activities throughout the year.

Hon. secretary: Mr. A. G. Tucker, 42, Drayton Road, Tottenham, N.15.

## Constructing Loud-speakers.

Loud-speakers of the paper cone type formed the subject of an interesting demonstration at the Muswell Hill and District Radio Society's meeting on October 20th. Mr. Cauldwell exhibited and described the construction of a number of pleated speakers, and was followed by Mr. Anderson, who demonstrated a cone loud-speaker built to fit inside the boss of an aeroplane propeller. This instrument gave particularly good reproduction of low tones.

Hon. secretary: Mr. Gerald S. Sessions, 20, Grasmere Road, Muswell Hill, N.10.

## Is H.F. Amplification Worth While?

"Is one stage of high frequency amplification worth while?" was the question debated at an enthusiastic meeting of the North Middlesex Wireless Club on October 13th. Speaking in favour of H.F. amplification, Mr. Forbes admitted

that in London, and on wavelengths below 200 metres, there was not much advantage to be gained, but he considered that the general improvement in efficiency justified the small extra outlay. Mr. Gartland, who answered the question in the negative, maintained that as much advantage could be obtained from the judicious use of reaction, properly controlled so as to be smooth in action, as from the addition of one H.F. valve with its necessary damping devices. Mr. F. T. Chapple, the chairman, in summing up, said that the keenness of the debate indicated that the best course would be for the two protagonists to bring their apparatus to the club!

Prior to the debate Mr. Laister demonstrated a one-valve portable receiver, using only a frame aerial 8in. x 12in., which gave excellent results, although the instrument was operated in a corrugated iron building.

Hon. secretary: Mr. H. A. Green, 100, Pellatt Grove, Wood Green, London, N.22.

## Transmission on Five Metres.

At the Streatham Radio Society's meeting on October 7th Mr. F. L. Hogg gave an interesting description of transmission tests carried out during the summer on wavelengths of the order of five metres.

A number of interesting fixtures have been arranged for the winter session.

Hon. secretary: Mr. H. Bevan Swift, 49, Kingsmead Rd., Tulse Hill, S.W.2.

## FORTHCOMING EVENTS.

### WEDNESDAY, NOVEMBER 3rd.

Institution of Electrical Engineers. Wireless Section.—At 6 p.m. (Light refreshments at 5.30.) At the Institution, Savoy Place, W.C.2. Inaugural Address by the Chairman, Prof. C. L. Fortescue, O.B.E.

Wireless and Experimental Association.—At 8 p.m. At the Camberwell Central Library, Peckham. Lecture: "Submarine Telephony," by Mr. Ricketts, of Niche Gorman and Co.

Barnsley and District Wireless Association.—At 8 p.m. At 22, Market Street. Simple Elements of Wireless and Demonstration on Transmitter. (Lecturer, Mr. G. W. Wigglesworth.)

Edinburgh and District Radio Society.—At 8 p.m. At 117, George Street. Business Meeting and Visit to Telephone House.

Muswell Hill and District Radio Society.—At 8 p.m. At Tollington School, Tetherdown, N.10. Demonstration of a German 6-valve Uni-Control Receiver by Messrs. Richard and James Garvey.

North London Experimental Radio Society.—Lecture: "Thermionic Valves," by Mr. L. H. Bedford.

### THURSDAY, NOVEMBER 4th.

Golders Green and Hendon Radio Society.—At 8 p.m. At the Club House, Willifield Way, Golders Green, N.W.11. Lecture: "The Development of Valves in Broadcasting," by Mr. F. E. Henderson (of the General Electric Co., Ltd.).

### MONDAY, NOVEMBER 8th.

Southport and District Radio Society.—Open Night at St. Morca's Hall, Part Street.



# READERS' PROBLEMS

"The Wireless World" Information Department Conducts a Free Service of Replies to Readers' Queries.

Questions should be concisely worded, and headed "Information Department." Each separate question must be accompanied by a stamped addressed envelope for postal reply.

## Using the Electric Light Mains as an Aerial.

Some time ago adapters were advertised for connecting to any electric light socket in order to use the house wiring system in place of the aerial and earth. Is it possible to experiment with this method without going to the expense of purchasing one of these adapters, as I understand that the method is not always successful?

H. M. B.

These adapters consist of an ordinary electric light adapter and a fixed condenser, the condenser serving the purpose of readily by-passing all H.F. currents picked up by the mains to the lead coming from the aerial terminal of the receiver, which of course is connected to the other side of the condenser. Usually this method was only satisfactory on the local station, and even then success could not be assured. A test is really the only reliable method of determining whether this system would be successful in any particular locality.

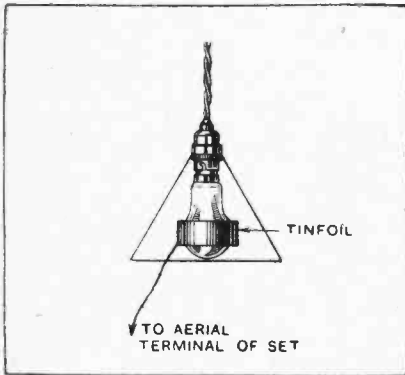

Fig. 1.—Method of fixing tin foil band for using mains as aerial.

A rough test can easily be made by wrapping a piece of tin foil round the electric light globe, a wire being attached to the tin foil and led down to the aerial terminal of the set. The system then operated by virtue of the capacity existing between the tin foil and filament through the glass globe, which acted as

a dielectric. This method usually gave reasonably good results on the normal broadcasting wavelengths, but poor results on the Daventry wavelength owing to the higher impedance which it offered to the lower frequency corresponding to the Daventry wavelength. There was, however, not the slightest danger of shock, of damage to set, or of blowing of fuses, using this method.

A more reliable method is to use an ordinary adapter from which a wire is led to one side of an ordinary fixed condenser of 0.001 mfd. capacity, the other side of this condenser going to the aerial terminal of the set. There is obviously some danger of shock using this method, and at the same time it would be well to see that the fixed condenser used was capable of withstanding the mains' voltage, otherwise blowing of fuses and damage to set might occur.

o o o

## The Simplest H.T. Battery Eliminator.

I am in possession of a crystal receiver which gives good results on headphones both from the London and Daventry stations. I desire to add a two-stage L.F. amplifier to this instrument for the purpose of operating a large loud-speaker. I intend to use two six-volt power valves. The question of L.T. supply does not worry, as I already have a number of six-volt accumulators for other purposes. The question of plate current supply will be a problem, however. I want a reliable and trouble-free supply which is at the same time inexpensive both in initial cost and in upkeep. H.T. batteries of the dry type are ruled out, since they are by no means trouble-free, nor are they inexpensive. H.T. accumulators are prohibitive in initial cost. I have 110-volt D.C. mains, but most of the apparatus for obtaining H.T. supply from the mains appears to be complicated and expensive. Can you suggest a solution to my problem?

C. D.

Undoubtedly the ideal solution of your problem lies in the intelligent use of the electric light mains. The only apparatus which you will require is a suitable choke and two fixed condensers. It is only when complications are introduced, such as the necessity for a separate value of

H.T. to each valve in the receiver, that the initial cost of the apparatus becomes expensive and its installation complicated, because not only are lamps or a tapped resistance necessary as potential dividers, but separate chokes and condensers must be used for each H.T. tapping. In your case, however, both valves require the same value of H.T., and since practically all of these valves operate on 100 to 120 volts H.T. your mains' voltage is ideal. You will require no complicated apparatus, and need not bother about lamps or resistances, and, moreover, the current consumed from the mains will be very small indeed, since it will only be equal to the current actually flowing in the plate circuit of the valves, no energy having to be supplied for the wasteful purpose of heating up lamps or resistance potential dividers. Using two low impedance valves, the total current drawn from the mains will be about 10 milli-

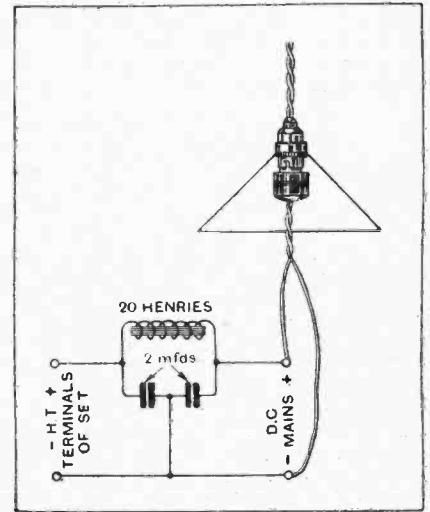

Fig. 2.—Simple H.T. eliminator circuit.

amperes, which at the rate of 6d. per unit would work out at about one penny for six weeks' use, allowing an operating period of four hours every night, which compares favourably not only with the cost of batteries of all types, but also with the running cost of most mains' units. A complete circuit diagram of this unit is given in Fig. 2.

With regard to the choke, a value of 20 henries is usually quite sufficient, whilst on most mains a value of 2 mfd. for the two fixed condensers is adequate, but at the same time it must be admitted that the commutator ripple on many sources of supply is so great that the value must be considerably increased. Usually, however, 4 mfd. is ample, and this may either consist of two 2 mfd. or four 1 mfd. condensers connected in parallel, or actual 4 mfd. condensers may be purchased at a cost of 9s. each. It is as well, also, that a similar condenser be placed in the earth lead of the receiver as a measure of absolute safety, irrespective of which main is earthed.



# The Wireless World

AND  
RADIO REVIEW  
(14<sup>th</sup> Year of Publication)

No. 376.

WEDNESDAY, NOVEMBER 10TH, 1926.

VOL. XIX. No. 19.

Assistant Editor:  
F. H. HAYNES.

Editor:  
HUGH S. POCOCK.

Assistant Editor:  
W. JAMES.

Editorial Offices: 139-40, FLEET STREET, LONDON, E.C.4

Telephone: City 4011 (3 lines).

Advertising and Publishing Offices: DORSET HOUSE, TUDOR STREET, LONDON, E.C.4

Telephone: City 2847 (13 lines).

Telegrams: "Ethaworld, Fleet, London."

COVENTRY: Hertford Street.

BIRMINGHAM: Guildhall Buildings, Navigation Street.

MANCHESTER: 199, Deansgate.

Telegrams: "Cyclist Coventry."  
Telephone: 5210 Coventry.

Telegrams: "Autopress, Birmingham."  
Telephone: 2970 and 2971 Midland.

Telegrams: "Hiffe, Manchester."  
Telephone: 8070 and 8071 City.

Subscription Rates: Home, 17s. 4d.; Canada, 17s. 4d.; other countries abroad, 19s. 6d. per annum.

As many of the circuits and apparatus described in these pages are covered by patents, readers are advised, before making use of them, to satisfy themselves that they would not be infringing patents.

## THE RECRUITING CAMPAIGN.



At the time these lines appear in print, "National Wireless Week"—if it is to achieve the object for which it was promoted—should be in full swing, and it is to be hoped that the army of wireless listeners will have been greatly extended by an influx of new recruits. We would like to feel that every reader is taking some part in furthering this desirable object, and, even if he is successful in adding only one recruit, it is still worth while.

"National Wireless Week" coincides with the fourth birthday celebrations of the B.B.C., and we understand that the B.B.C. are sparing no pains to make the programmes during the week of special interest.

In giving demonstrations to our friends during "National Wireless Week," we undertake a certain responsibility, for the results will depend very largely on the quality of reproduction which we set forth as a standard, but in this respect we have every confidence in our readers, and believe that a very high standard is attained by them which should do full justice to the quality put out by the stations of the B.B.C. But let us see to it that we are quite satisfied with the performance which we can give at a demonstration before we invite our friends to listen, because a bad demonstration may be much more disastrous in its effect than no demonstration at all, and we believe that there is a very large proportion of the public to-day which would have joined

the ranks of wireless listeners long ago if it had not been for the fact that what experiences they have had of listening to broadcasting have been disappointing from the view of quality.

There is another aspect of recruiting also which calls for consideration.

It should be remembered that the primary object of "National Wireless Week" is to bring wireless into every home, and, if we are only successful in so far as we induce our friends to install a cheap crystal set, we shall still achieve a good deal. The new recruit should learn to walk before he attempts to run, and a crystal set is a very good beginning which will serve to start him off. We need have little fear that once started he will ever go back. We must not expect a ready response in all directions to a suggestion to the novice to build his own set, because in many cases it will take time to acquire sufficient interest in the practical side of wireless for such a task to be undertaken, and we should remember that to-day there is a wide selection of efficient receivers on the market at reasonable prices. This is where we believe that *The Wireless World* Buyer's Guide" incorporated in this issue will be of service, not only to the

### CONTENTS.

	PAGE
EDITORIAL VIEWS ... ..	623
LOUD-SPEAKER FOR HOME CONSTRUCTION ... ..	624
By A. P. Castellain.	
READERS' NOVELTIES ... ..	628
PRACTICAL HINTS AND TIPS ... ..	629
SUPERSONIC TRANSFORMERS. PART 1 ... ..	631
By N. W. McLachlan.	
CURRENT TOPICS ... ..	635
THE CHOICE OF A WIRELESS SET ... ..	637
NEWS FROM THE CLUBS ... ..	640
BUYER'S GUIDE TO WIRELESS SETS ... ..	641
BROADCAST BREVITIES ... ..	659

new recruits, but also to our readers, in assisting the novice in the choice of a set if he prefers to buy rather than to make one. We have so constantly received enquiries from our readers for particulars of manufacturers' sets in order to assist them in advising their friends that we feel more than ever that our "Buyer's Guide" will be a book of reference during "National Wireless Week."

## LOUD-SPEAKER FOR HOME CONSTRUCTION

An Economical Design Giving  
Good Quality Reproduction.

By A. P. CASTELLAIN, B.Sc., A.C.G.I., D.I.C.

**T**HE loud-speaker is a part of the set which is usually considered outside the scope of the average amateur constructor, who perhaps has felt that anything he can make in this line will not compare favourably with existing commercial articles, so that this component has been left severely alone.

Loud-speakers may, in general, be divided into three main classes: (a) the horn type, (b) the large diaphragm with *fixed edge*, and (c) the large diaphragm, or cone, with *free edge*. The horn type is generally regarded as the most efficient, but its efficiency too frequently depends on resonance effects in the diaphragm and in the

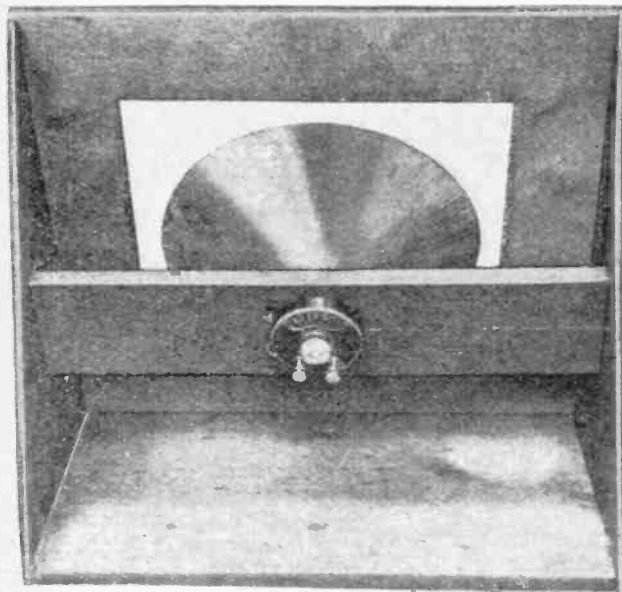

View of the speaker with back removed to show the cone and method of mounting.

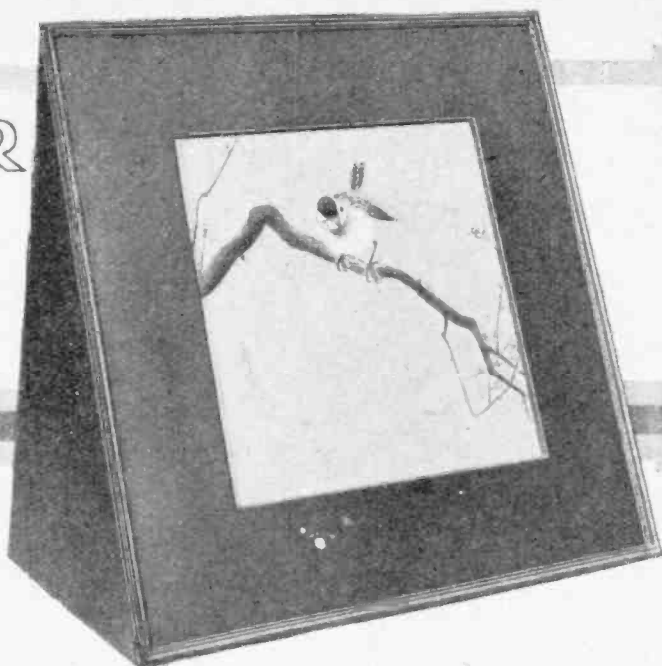

horn, and therefore there is bound to be distortion (*i.e.*, unequal response for different frequencies or notes), since the particular frequencies corresponding to horn or diaphragm resonance periods will be amplified more than the others.

For the man who wants a cheap loud-speaker, which, although low in cost, yet gives good quality output, there is nothing to beat the cone type. In any case, the horn of the more usual type is quite outside the capabilities of the tools possessed by the average home constructor, quite apart from the fact that the design of such a horn is a highly skilled piece of work.

The choice of a home-constructed speaker therefore lies between the "fixed edge" and the "free edge" cone or diaphragm, and it would be as well first to discuss the relative merits of each. First of all, by "fixed edge" diaphragm is meant a diaphragm clamped round the edges, as is the diaphragm in the ordinary telephone earpiece, and with the movement imparted at the middle; while the "free edge" diaphragm is fixed at its centre to the moving mechanism, but is quite free at its edge.

The two types behave quite differently in operation, the "fixed edge" being so clamped that only the centre part moves, while the "free edge" type moves, or should move, as a whole.

Owing to the clamping of the fixed edge type, there are bound to be resonance effects, but not so pronounced as in the case of the horn loud-speaker. These effects may be minimised by pleating the diaphragm—as is done in the Sterling Primax—or by using a double elliptical cone, as in the case of the Standard Telephones "Kone" loud-speaker; but even so, there are plenty of snags for the home constructor to run up against.

The last class—the free edge diaphragm—is by far the easiest to construct—as witness the details given in this article—and can be made to give really good quality speech and music.

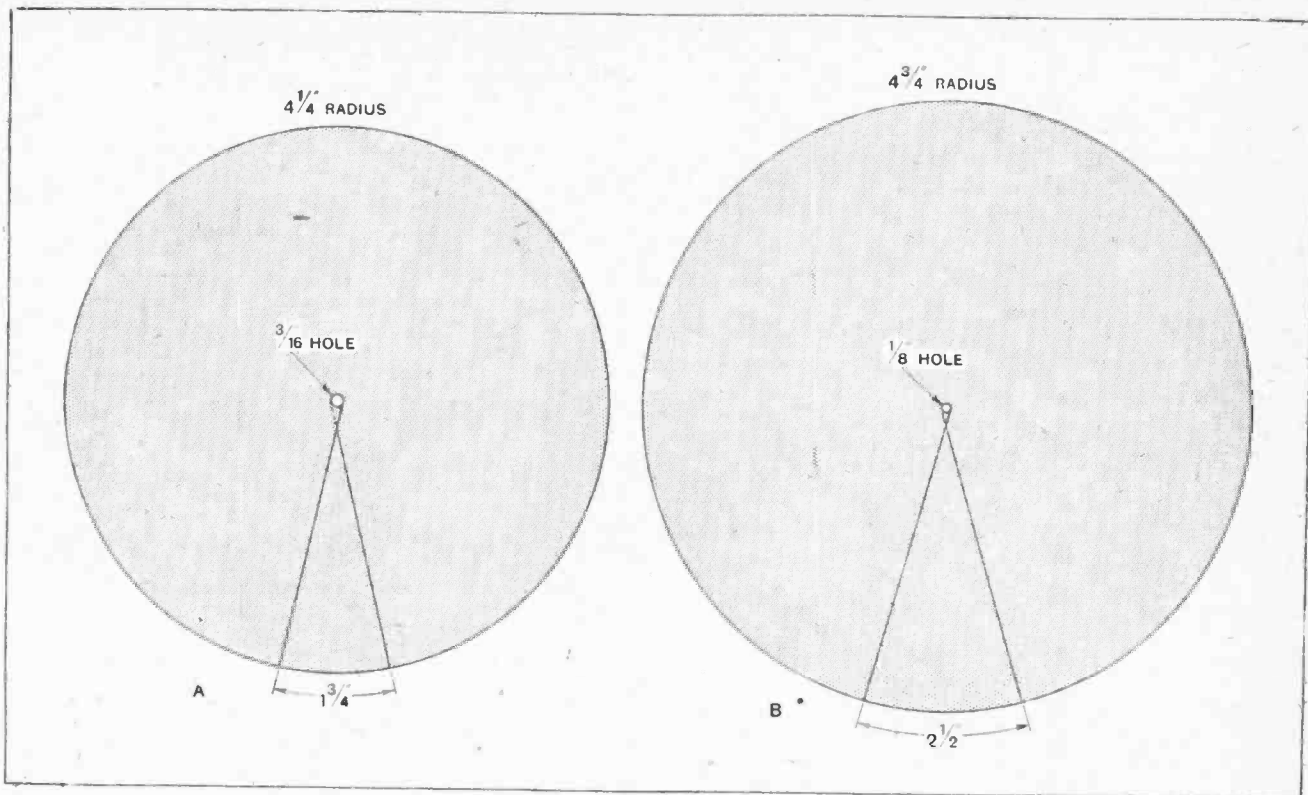

Fig. 1.—Dimensions of the paper circles from which the cones are made. Note carefully that the apex of the sector which must be cut out from each circle does not coincide with the centre of the circle.

Since the diaphragm is to move as a whole it must be extremely rigid so as not to buckle when dealing with rapid vibrations, but at the same time it must be extremely light so as not to waste more power supplied to it than is absolutely necessary in moving itself, or its efficiency will be very low as compared with other types.

A cone of thin material is a rigid arrangement to use, and the double cone construction is extremely rigid, while being very light, if drawing paper is used.

**Construction of the Cone.**

Two circles should be cut out of drawing paper to the dimensions shown in Fig. 1, and the lines there shown drawn in pencil. Note carefully that the apex of the sectors which must be cut out from each circle does *not* coincide with the centre of the circle.

These circles are now given two coats of *thin* shellac varnish, about half an hour elapsing between the coats to allow for drying. It is best to make up the shellac varnish at home by dissolving solid shellac flakes in methylated spirits in a clean bottle and stirring well until the flakes are dissolved. Plenty of spirits should be used to give a thin coating, but it is usually more convenient to make up the shellac varnish fairly thick, and then to add more methylated to a small quantity as required.

When shellacking the paper, use a large brush and work quickly and evenly over the whole surface, and if the paper tries to curl up, let it do so, as it can easily be straightened out afterwards by careful rolling in the opposite direction to the curl. While waiting for the circles to dry, the paper tube by which the cone is fixed to the

movement may be constructed. It consists of a strip of paper about 2 1/2 in. long and about 2 in. wide rolled up and stuck with seccotine.

The movement chosen for this loud-speaker is known

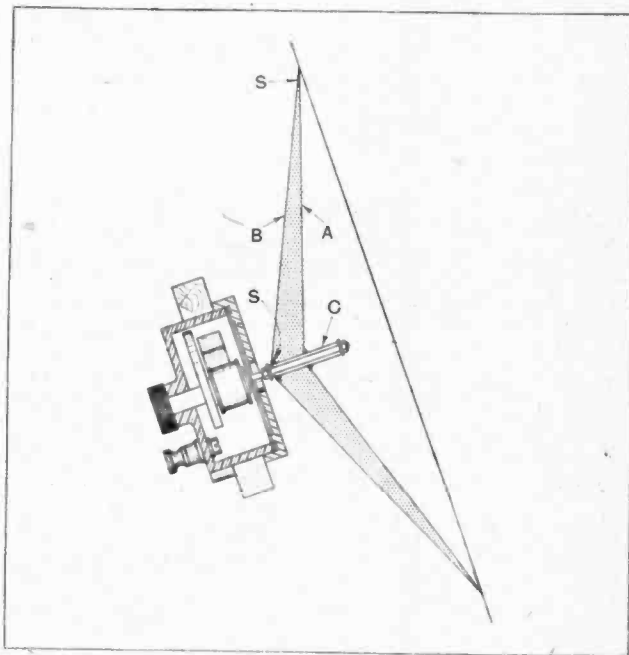

Fig. 2.—A section through the loud-speaker showing how the cones are fixed to the reed. A and B are the two cones C, paper tube; S, seccotine.

**Loud-speaker for Home Construction.—**

as the Lissenola, with reed attachment. The writer would have preferred a larger movement so as to obtain greater volume, but there is not one obtainable at anything like a comparative price.

The Lissenola with the cone described gives very good quality indeed both for speech and for music, but the volume does not compare with that of larger cone speakers, such as the "Kone."

joins in the cones are setting; otherwise, a long narrow box is useful to press the join flat on to a table while setting.

When the cones are ready, cut a small shoulder in one end of the paper tube with an old razor blade; the paper will peel away all right if a cut is made all round about  $\frac{1}{8}$  in. from the end of the tube.

The paper should be removed until the tube will just push through the hole in the bottom of the larger cone,

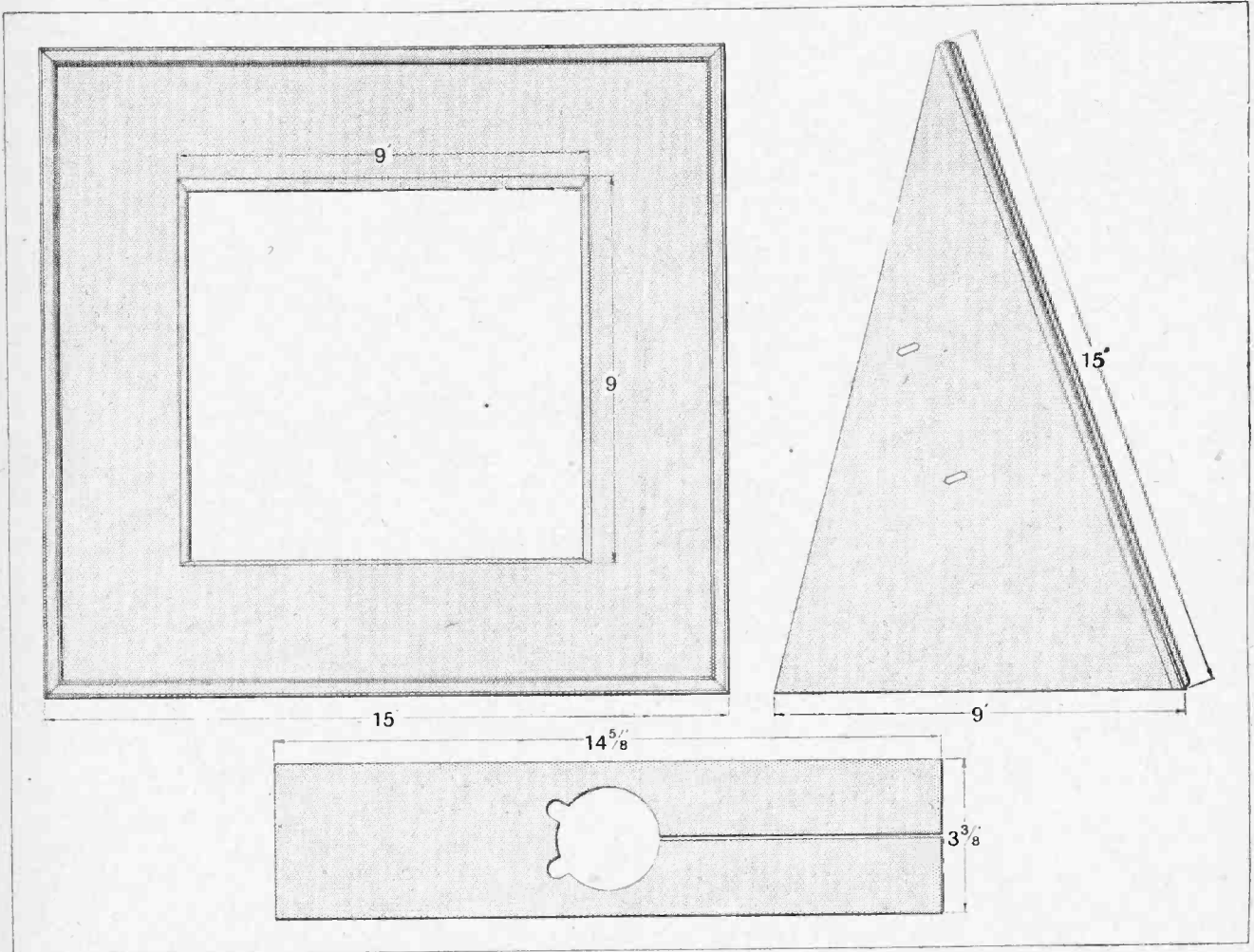

Fig. 3.—Dimensions of the 3-ply-wood case, and of the clamp for the unit, made of half-inch wood.

However, it is not really fair to compare the output of one of these home-built speakers with a "Kone," as one can make half a dozen for less than the price of a "Kone," and two for less than the price of a cheaper type—the Sterling "Mellovox."

**Assembling the Cone.**

To return to the construction, the triangles and centre holes should be cut out from the circles, and the remaining sectors bent up to form two cones, the join being stuck with seccotine. If there is a bench vice handy it comes in very useful to clamp the paper while the

and then the tube is cut to length at the other end until just enough room is left on the reed for a nut and washer top and bottom. It is advised that the spindle of the reed be threaded (No. 7 BA) right to the bottom so as to obtain a long bearing surface for the cone, and the projection on the cap of the Lissenola unit cut or filed away.

The tube is pushed through the larger cone until the latter comes up against the shoulder, and then all is made firm with seccotine. While waiting for this to dry, the smaller cone may be threaded over the tube and the outer edge fixed to the other cone with seccotine.

When the seccotine has set, put some more where

**Loud-speaker for Home Construction.—**

the smaller cone passes round the tube and stretch this cone by putting a cotton reel over the tube with a suitable weight—such as a book—on top of it, so that the seccotine may set with the inner cone in tension. Fig. 2 shows a section of the finished cone when mounted on the Lissenola unit.

So much for the cone. The unit needs no alterations beyond those suggested, and the method of mounting it can be seen from the photograph and from Fig. 3. Briefly, it consists in drilling or cutting a suitably shaped hole for the unit in a wooden bar and then cutting a slit in the bar so that the hole may be sprung out a little. A screw is used to clamp the two slit portions when the unit is in place.

The case of the loud-speaker may be left to the individual tastes of the reader; but the general design given in this article (dimensions in Fig. 3) is to be recommended as providing an unusual and pleasing form.

The picture used by the writer is a real Japanese print, which may be obtained from Ken Hoshino & Co., 19, Sicilian Avenue, Southampton Row, Holborn, London,

W.C.1—who, by the way, have a large selection from which to choose—for the modest sum of 1s. 6d.

The adjustments provided on this loud-speaker are two in number—the usual magnet one on the unit itself, and an adjustment formed by slots in the casing for the screws which hold the wooden clamp for the unit, so that the cone may be moved right up to, or away from, the back of the picture. The writer found it advisable, in order to get over the difficulty of reed resonance on large inputs, to put three little pads of cotton wool between the edge of the cone and the back of the picture and to adjust the cone to press on these.

In this way the reed was damped sufficiently to eliminate objectionable effects.

The total cost of the loud-speaker is 18s., including Lissenola unit and reed, paper, shellac and spirits, wood, screws, and the picture, so that even if the reader has a loud-speaker already, he will not be much out of pocket for another of the type described with which to experiment, and he will probably find, as the writer has found, that the unusual design combined with the good quality reproduction is much appreciated.

**General Notes.**

Mr. E. Willis Stratton, Jun. (U 8DDL), 95, Aberdeen Street, Rochester, New York, will be testing every Sunday morning from 0330 to 0400 G.M.T. and will welcome reports. He will call GLB, GLB, GLB — GC — 8DDL. These tests will take place between the "FNB" tests noted on page 379 of our issue of September 15th.

o o o o

Mr. F. R. Neill (GI 5NJ), Chesterfield, Whitehead, Co. Antrim, was in communication, on October 24th, at 7.0 p.m. G.M.T., with a station in Hong Kong. He was working with an input of 75 watts to an Osram D.E.T.1 valve, and his signals were reported R6. This is believed to be the first two-way working between amateurs in Northern Ireland and China.

o o o o

A Spanish contemporary, to whom we referred under "Current Topics" of our issue of September 1st, continues its glossary of "Radiese" for the benefit of Spanish amateurs. Among the definitions in a recent number we find "OW"—Old Woman (dangerous to use!)—vieja amiga (de empleo peligroso).

o o o o

Mr. L. J. Fuller, hon. sec., Q.R.P. Transmitters' Society, sends us the following account of recent tests on low power with and without aerials:—

"Mr. Guy, of Pinner (ZCS), has worked 450 miles on 45 metres on 1.8 watts with no aerial attached to the set, but using the usual single wire counterpoise. Mr. Fynn, of Woodford (6 TX), has successfully transmitted telephony over short distances with no aerial or counterpoise, using 1 watt on 45 metres. The carrier wave was modulated 90 per cent. by using 1 turn of wire attached to the microphone and coupled to the plate end of the Hartley coil. Mr. Fynn has also perfected the twin feed Hertz aerial. Using this attached to the transmitter, and still on

**TRANSMITTERS' NOTES AND QUERIES.**

1 watt, telephony has been received R5 in Rome and Madrid, employing the same method of modulation. On 150 metres. 6LL is received, with no change in signal strength, with or without an aerial, by 6HY, 2½ miles distant."

"It is thought that these tests may open up another channel for amateur investigation."

o o o o

We are frequently asked to interpret the International "Z" code used in Transoceanic Traffic, and are now able to give particulars, for which we acknowledge indebtedness to "Q.S.T. Francais."

- ZHC How are you receiving?
- ZAN We can receive absolutely nothing.
- ZSU Your signals are unreadable.
- ZWR Your signals are weak but readable.
- ZMR Your signals are moderately strong and readable.
- ZSR Your signals are strong and readable.
- ZGS Your signals are stronger.
- ZGW Your signals are weaker.
- ZVS Your signals are variable.
- ZSH Strong atmospherics here.
- ZLS We are disturbed by a storm.
- ZWC Crackling atmospherics here.
- ZVP Please send V's.
- ZWO Send each word once.
- ZWT Send each word twice.
- ZCO Send by code, each group once.
- ZCT Send by code, each group twice.
- ZPO Send text in plain language once.
- ZPT Send text in plain language twice.
- ZTF Send twice, quickly.
- ZSF Send quicker.
- ZSS Send slower.
- ZRO Are you receiving at maximum speed?
- ZOK We are receiving at maximum speed.
- ZNG Conditions unfavourable for reception by code.
- ZNN Everything stopped, provisionally.
- ZHY We have your . . .
- ZCS Hold up your transmission.
- ZHA What are the conditions for automatic reception?

- ZUA Conditions unfavourable for automatic reception.
- ZTA Send automatically.
- ZPP Send text only, in plain language.
- ZPE Send everything.
- ZFA Automatic system out of order.
- ZSA Stop automatic traffic.
- ZSW Stop automatic traffic because signals are too weak.
- ZSJ Stop automatic traffic because of jamming.
- ZSG Stop automatic traffic and examine transmitter.
- ZSV Your speed is variable.
- ZSB Your signals are not clear (sharp).
- ZDM We are missing your dots.
- ZTV Send by the rapid automatic.
- ZTH Send by hand.
- ZHS Send at the rate of . . . words per minute.
- ZDD Make your dots and dashes thus . . . . .
- ZLB Make long intervals.
- ZUB We cannot interpolate (break in upon) you.
- ZNB We are not receiving your interpolations; we will send twice.
- ZMQ Wait.
- ZMO Wait a minute.
- ZKQ Let us know when you are ready to begin again.
- ZDU Our Duplex is out of order.
- ZFT What are the conditions for Triplex?

**Reception of American Broadcasting.**

A correspondent in Glasgow writes that he constantly receives U 2XAF on 32.79 metres, and U 2XG on 35.45 to 42 metres, at signal strength varying between R5 and R9 on an 0-v-2 receiver. Both have been received as early as 6.15 p.m. B.S.T., and, on the morning of Sunday, October 24th, 2XAF came in strongly at R7/8 at 9.15 a.m. G.M.T. He also asks if anyone has lately heard U 2XG on 22.5 metres telephony.

o o o o

Another correspondent, at Worcester, picked up U 2XAF on October 30th at 10.10 a.m. G.M.T., when it was daylight over practically the whole of the Atlantic. The receiver used was a modified Reinartz 0-v-1 with a 40ft. aerial 30ft. in height, and with no counterpoise or earth.

o o o o

**A Correction.**

In our issue of October 20th (page 550), Mr. N. E. Haigh's call-sign was given as G 6NC; this should have read G 6NG.





# READERS' NOVELTIES

A Section Devoted to New Ideas and Practical Devices.

## LEAD-IN IMPROVEMENT.

Breakage of the down-lead at the point where it is attached to the lead-in tube terminal is a frequent source of trouble, and may be overcome in the following manner.

The end of the lead-in tube is recessed to take an ordinary rubber bung of the type used in chemical apparatus. The down-lead is passed through the centre hole in the rubber bung and soldered to the rod passing through the lead-in tube, which has been shortened to an appropriate length. The rubber bung gives

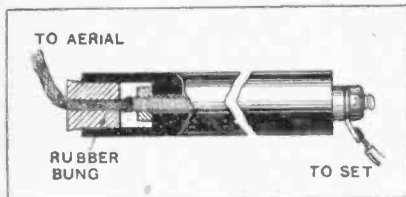

Improved lead-in tube.

slightly to the strains imposed by the swaying of the down-lead, and any bending of the wire is distributed instead of being concentrated at the joint.—W. H. G.

## ADJUSTABLE FILAMENT RESISTANCE.

Many receivers are being designed which derive grid bias from a tapping on the filament resistance, and for this purpose a semi-variable resistance element is desirable.

The diagram shows a resistance of this type in practical form.

The resistance wire is wound on a

piece of ebonite rod,  $\frac{3}{8}$  in. in diameter, in the lower end of which is fixed an ordinary valve pin. This is plugged into a valve socket mounted on a short ebonite base, which also carries a

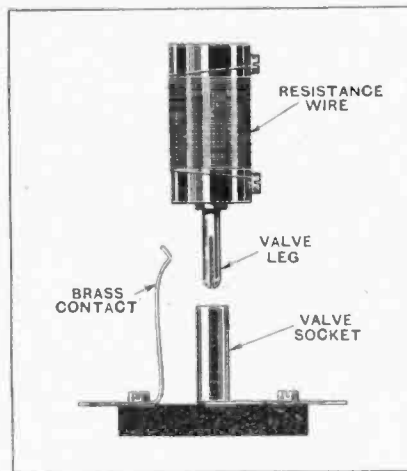

Adjustable filament resistance.

springy brass contact strip. The value of the resistance in circuit is adjusted by raising or lowering the valve leg in the socket, fine adjustment being obtained by rotation of the ebonite former.

Normally, the lower end of the resistance coil is connected to the valve leg, but a potentiometer effect can be obtained by connecting the filament

## VALVES FOR IDEAS.

Readers are invited to submit brief details, with rough sketches, where necessary, of devices of experimental interest for inclusion in this section. A dull emitter receiving valve will be despatched to every reader whose idea is accepted for publication.

Letters should be addressed to the Editor, "Wireless World and Radio Review," Dorset House, Tudor St., London, E.C.4, and marked "Ideas."

leads to the two grub screws on the ebonite former, using the brass strip to make contact at a suitable point on the coil.—P. J. W.

## BACK-OF-PANEL COIL HOLDER.

Although extremely simple in design and construction, the coil holder illustrated in the diagram operates on a perfectly sound principle, and can be thoroughly recommended where fine adjustment is required without backlash.

Two ordinary coil plugs are employed, the fixed plug being screwed to the panel with countersunk screws passing through from the front. The moving coil holder is supported by an ordinary cabinet-maker's hinge. This hinge should be of good quality and free from play in the joint. The coupling between the coils is varied by means of a screw adjustment passing through a brass bush in the panel

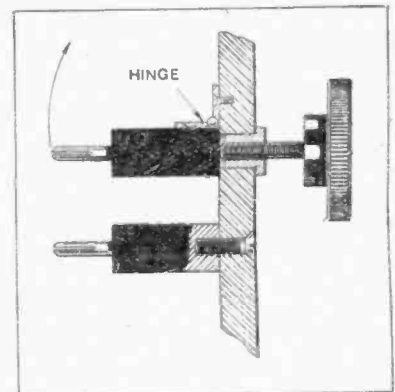

Simple adjustable coil holder.

As the adjusting knob is screwed forward, the moving coil moves upwards in the direction of the arrow. The device is gravity controlled, and is consequently free from backlash.—W. H. G.

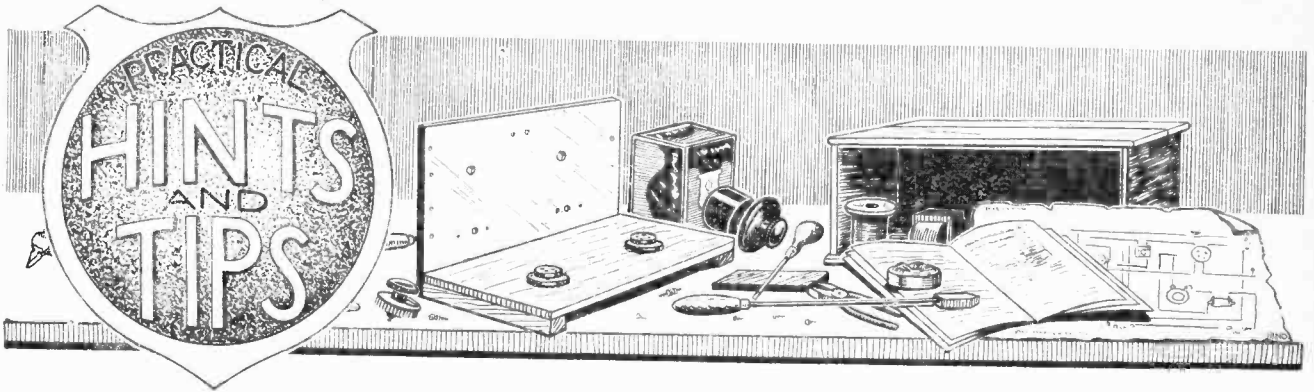

A Section Mainly for the New Reader.

**MOUNTING A VOLTMETER.**

The majority of small moving-coil meters, suitable for measuring H.T., L.T., and grid bias voltages, are supplied with a flange for mounting flush with the panel. Another type, sometimes with terminals at the side, is fitted in such a way that it pro-

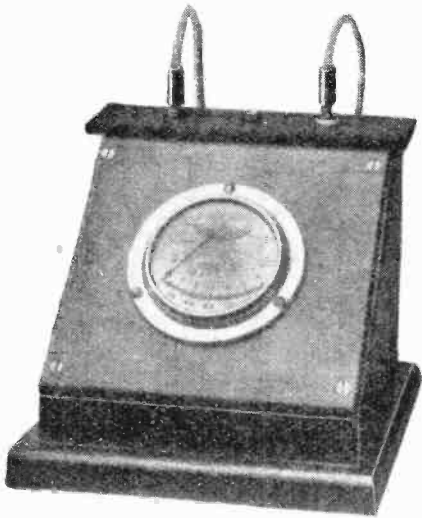

A two-range voltmeter mounted in a case with sloping panel.

jects from the panel. The majority of amateurs will naturally prefer the "two-range" type, by means of which readings may be obtained over a wide range of voltages; these instruments are much cheaper than the two voltmeters which would otherwise be necessary.

When the meter is included in the set, some form of switching is necessary if the fullest possible use is to be made of it; suitable arrangements were shown in this section of *The Wireless World* in the issues

dated August 11th and August 25th, 1926. As the connections are somewhat complicated and an appreciable amount of panel space is required, many amateurs will prefer not to incorporate the meter in their sets; in such cases it is advisable to mount it in some form of box with insulated sockets for picking up connection with the terminals. This, of course, only applies to the less expensive instruments, as the higher-priced ones are usually enclosed in a case with a solid base.

It will be found convenient to mount the panel carrying the meter at an angle of about 45 degrees, as the scale is more easily readable in this position.

A suitable form of mounting is shown in the accompanying illustra-

tion. A small box, as sold by some dealers for containing a variable condenser, may be cut down to the required size without any very great difficulty.

o o o o

**MODIFYING THE "ECONOMY TWO."**

The most obvious method of increasing the range of the simple two-valve loud-speaker set, described in the issue of this journal dated October 27th, 1926, is to add a stage of high-frequency amplification. There are, however, other and simpler means of obtaining adequate signal strength at distances from the transmitting station greater than those for which the set was originally designed.

The addition of a "reactor" valve, as shown in Fig. 1, is prob-

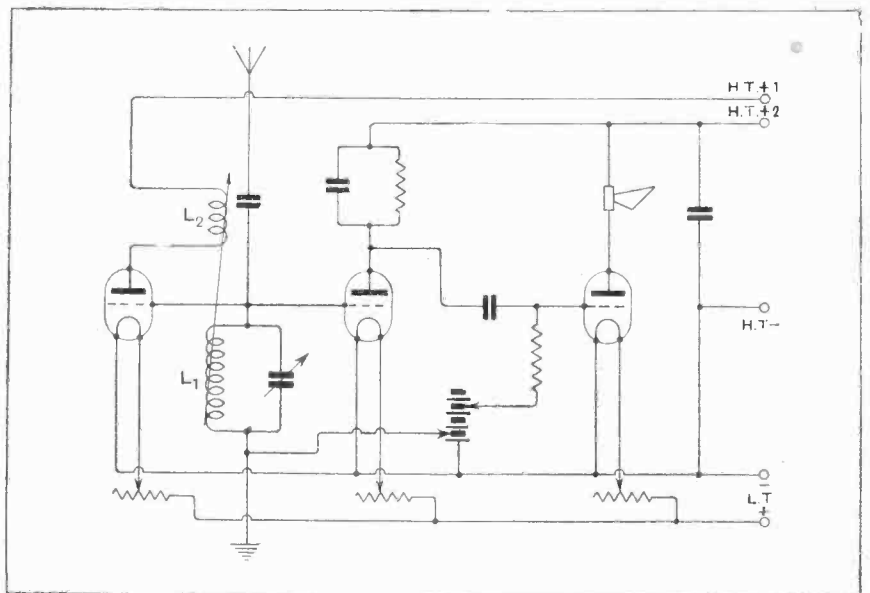

Fig. 1.—A detector L.F. combination with reacting valve.

ably the easiest and most certain way of making a great increase in the overall sensitivity of the receiver. While not giving results equal to a modern H.F. amplifying stage with a well-designed transformer, this simple arrangement is probably as effective as an ordinary "tuned anode" H.F. amplifier, and does not involve an extra tuning control. The coils  $L_1$  (the aerial tuning inductance) and  $L_2$  (the reaction coil) can be mounted on an ordinary two-coil holder with adjustable coupling.

A consideration of the circuit diagram will show that the grids of the reaction and detecting valves are joined together, and thus the bias ap-

plied to both of them is the same. As it is, of course, necessary that the detector should be working on the bend of its characteristic curve, while the reactor should be on the straight portion for smooth control of regeneration, it will be obvious that a valve of considerably lower impedance is necessary for the satisfactory performance of the latter function. If, however, it is desired to use a high-impedance valve with a low anode voltage, the difficulty of a common grid bias voltage may be overcome by inserting a small fixed condenser between the junction with the aerial lead and the reaction valve grid, and connecting a leak resist-

ance between this grid and the negative side of the filament.

The sensitivity and selectivity of the set may also be improved by substituting a loose-coupled aerial arrangement for the direct connection which was primarily adopted for the sake of simplicity. It will depend largely on the resistance of the aerial-earth system as to whether this alteration results in a very considerable increase in volume, but in the majority of cases there will be a very noticeable improvement. It is suggested that, to avoid the necessity of a separate tuning control for the aerial circuit, a "fixed tune" coupler should be used.

DISSECTED DIAGRAMS.

Step-by-step Wiring in Theory and Practice.

No. 48 (b).—A Single-stage H.F. Amplifier with Anode Detector.

(Concluded from last week's issue).

*In this series of diagrams it is hoped to make clear the steps to be taken in converting theory into practice in the construction of various typical wireless receivers. The arrangement shown below represents good modern practice, and may be followed by an L.F. amplifier, the first stage of which should generally be resistance-coupled.*

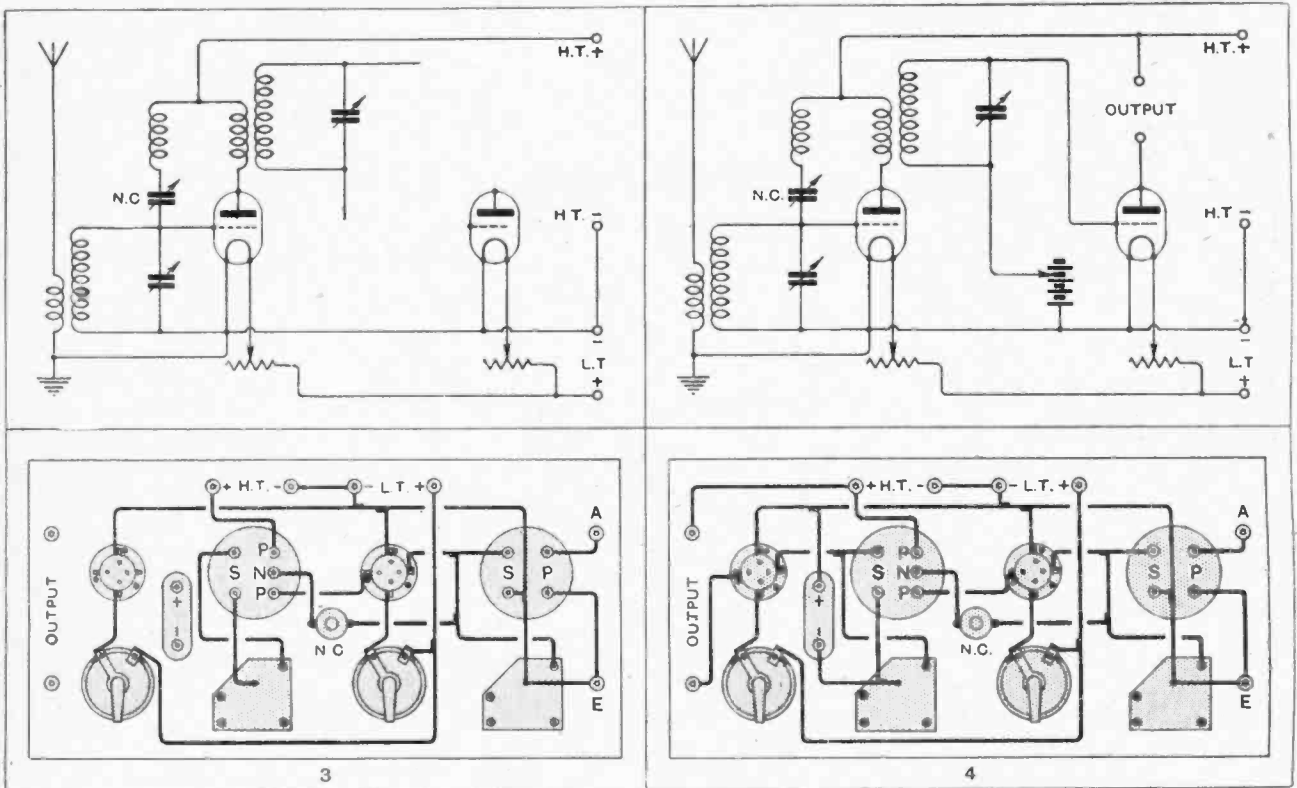

The anode circuit of the H.F. valve is completed through the primary winding of the tuned H.F. transformer and the H.T. battery. The parallel balancing winding is connected back to the grid through a neutralising condenser.

The secondary is connected across grid and filament of the detector valve, through a battery which imposes the necessary negative bias for rectification. The output terminals in the plate circuit are for connection to phones or amplifier.

# SUPERSONIC TRANSFORMERS.

## PART I.

### Notes on Design and Performance of Iron-cored Types.

By N. W. McLACHLAN, D.Sc., M.I.E.E., F.Inst.P.

THE use of iron in the intermediate stage of a supersonic heterodyne amplifier has had little attention in this country, although it has been studied to a certain extent in America. This is doubtless due to two salient factors—(a) the prevalent use of the supersonic system in the U.S.A., and (b) the ability to obtain suitable iron for constructing the transformers. There are various sides to the problem, and it is often the conditions of service which are responsible for the design to be adopted. For instance, if we have a good transformer which gives a ratio approaching that of the turns and a fairly flat tuning, and if we also have another transformer at slightly less cost whose performance is not far short, although the turn ratio is markedly greater than the step, which type will be chosen? I think such a question requires no answer. This is to an extent the problem in a nutshell. By using iron 1.5 mil thick I have been able to construct various types of transformer giving a step almost equal to the turn ratio with a valve of fairly low internal resistance and having a flat-topped magnification curve. But the cost of manufacture is probably just in excess of those in which the construction lends itself more to automatic machine work. Although it would be possible with high-grade thin silicon iron to get a ratio of nearly 5 : 1 or 6 : 1, with an optimum wavelength of 10,000 metres or less, it will be realised that a large magnification per stage is often accompanied by instability, or at any rate by sufficient reaction to cause poor quality, unless the neutrodyne principle is adopted. For instance, three 4 : 1 transformers with D.E.5B valves would almost certainly be accompanied by oscillation. This is almost to be expected when we compute the total magnification at  $27 \times 27 \times 27 = 20,000$ , taking the effective magnification to be 27 per stage.

#### Magnetic Condition of Iron.

The object of this article is to give results obtained with various designs of thin iron-cored transformers at wavelengths from 5,000 to 28,000 metres. Alongside these the results of an American transformer with practically no iron will be given. The reader must judge for himself which is the better practical proposition. The final form of the iron-cored instrument is not stated, but suggestions for improvements on the experimental models are offered to facilitate design.

Before describing the transformers and the experimental work associated therewith, it is advisable to say a word about the iron. As everyone knows, the permeability of iron varies with (a) the magnitude of the magnetisation, (b) the nature of the magnetisation. Taking case (b), the magnetisation may be either pure A.C. of single or poly-frequency or this may be superposed on a steady current. The latter condition is fulfilled in a valve circuit, where the A.C. is superposed on the magnetisation

due to the anode feed. There are then three factors which modify the permeability, and, therefore, the primary inductance of the transformer in which the iron is used. These factors are (1) the degree of steady magnetisation, or it may be termed the "polarisation," (2) the magnitude of the alternating magnetisation, (3) the frequency of the current. At any frequency and polarisation it is usual for the inductance (associated with permeability) to increase with the current up to a point, after which it decreases as saturation is approached. With given polarisation and constant A.C., the inductance decreases with increase in frequency. At constant frequency and low A.C. magnetisation the inductance increases with the polarisation up to a point, after which it decreases as saturation approaches. Thus the inductance with a reasonable polarising current will be greater than that obtained solely with a very small A.C. This is due to the characteristics of the magnetisation curves.

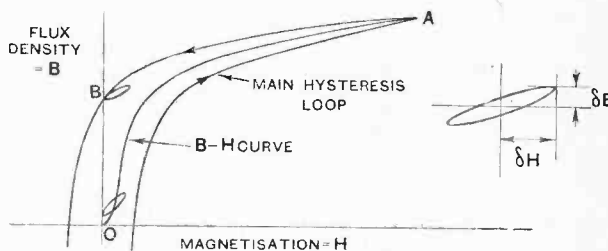

Fig. 1.—Differential permeability of iron (O) under normal conditions and (B) after saturation by current from H.T. battery.

The state of affairs which prevails in an intervalve transformer is illustrated in Fig. 1. The iron does not traverse a main hysteresis loop, but a subsidiary one, which is inclined at an angle to the B-H curve. Definitions of inductance are usually a trifle ambiguous when applied to iron-cored circuits. However, if we take a broad view of the matter and waive the academic attitude, the situation becomes quite easy. The inductance will, therefore, be defined as the change in line turns corresponding to a maximum alternating current of unit value. If  $n$  = primary turns,  $\phi$  = total sine flux change either positive or negative due to max. A.C.,  $I$  = current producing this change, we have by hypothesis  $L = \frac{n\phi}{I}$ .

It will be seen that  $\phi/I$  is proportional to the slope of the subsidiary loop considered as a straight line. Thus the inductance is in reality a differential quantity, and will vary with conditions as indicated previously. Similarly, the ratio is—

$$\frac{\text{Change in flux density}}{\text{Change in magnetising force}} = \frac{\delta B}{\delta H} = \text{differential permeability.}$$

**Supersonic Transformers.—**

Now, the values of  $\phi$  and  $I$  in interval transformers are usually very small and awkward to measure. It is precisely the inductance likely to be obtained in a valve circuit which one desires to know in order to get a starting point for the design. Experimental evidence shows that the differential permeability for small polarisation and small alternating magnetisation is of a similar order to that obtained by a bridge method of measurement using pure A.C. Accepting this, it is possible by the aid of a series of permeability and other curves associated with the iron to find a rough approximation to the permeability of the iron which may be expected. Thus when the dimensions of the transformer are fixed, the inductance could be calculated, *if the wavelength were known*. But this is where the argument breaks down, for without previous experience the wavelength cannot be ascertained. Even if we knew the self and mutual capacities, which are hardly calculable, the solution of the problem would be indeterminate without information regarding permeability. A first approximation can be made by finding the inductance at various frequencies, using the values of permeability obtained by experiment. The effective primary capacity is then found from trial coils. This enables the optimum wavelength to be computed from the equation  $\lambda = 1885\sqrt{LC}$ . The effective primary capacity is, of course, rather a difficulty, and its value may be larger than one might anticipate. This, however, is treated in a subsequent section. The alternative and perhaps safer method is to construct a transformer and take various measurements from which data for future designs can be formulated; but there must be some scientific mode of attack even here.

**Details of Transformers.**

By manipulating matters on the broad lines described above, the sizes of the stampings, etc., were made as shown in Fig. 2. In a transformer there are from 180

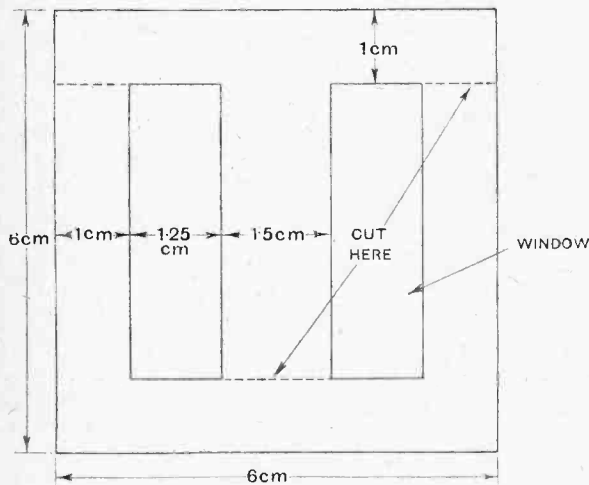

Fig. 2.—Dimensions of core stampings. The iron is 1.5 mils thick with 0.25 mil insulation on each side.

to 200 "E" pieces, and the same number of pieces shaped thus, [ ]. The size of the stampings was made liberal to

facilitate assembly, since they are only 2 mils thick over the insulation. The hole in the bobbin carrying the primary winding was also made fairly large for the same reason. To reduce self-capacity to a minimum, the primary was wound in a series of grooves. For simple mechanical construction the secondary was wound on a bobbin, which fitted comfortably over the primary. The general arrangement is shown in Fig. 3.

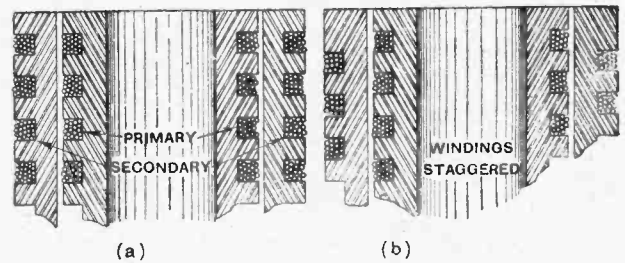

Fig. 3.—Disposition of primary and secondary winding slots in the ebonite formers; (a) ordinary windings, (b) staggered windings to reduce mutual capacity. The radial thickness of tube insulation is less than that shown here.

As an alternative, some transformers were made up with interleaved primary and secondary sections with spacing washers. Little was gained in performance, the assembly was more tedious, and the mechanical construction weak, there being many soldered joints and greater winding difficulties.

All the experiments were made on the same size of core, different optimum wavelengths being obtained by merely altering the number of turns on the primary and secondary windings.

Some additional experiments were made with ordinary 12 mil stalloy, but, as was expected from theoretical considerations, the results fell far short of those obtained with the 1.5 mil iron. The thicker material gives greater loss and smaller primary inductance, i.e., reduced  $\frac{L_1}{r_c}$ .

We have already shown in connection with audio-frequency transformers<sup>1</sup> that the internal resistance of the valve plays an important part. A high resistance sharpens up the peak of the amplification curve, whilst a low resistance broadens it out. Moreover, with a transformer of relatively low primary inductance, a low-resistance valve will give better results. The selection of valves now available is such that no difficulty is experienced in getting high or low magnification and good or poor selectivity. Thus there can be considerable flexibility in the design of the transformer, whilst obtaining a desired performance. This is seen in the design of the American transformer to be discussed later. The primary inductance is greater than that in the author's transformers of like wavelength. The iron is merely three thin strips of nickel-chrome alloy with a  $\frac{1}{16}$  in. air gap. Consequently, the greater part of the inductance is due to the coil *per se*. The result is a high effective resistance, large leakage, and a flat topped curve. The leakage in this transformer is considerable, for the coils are merely placed side by side, not being interleaved.

<sup>1</sup> *The Wireless World*, January 20th and 27th, 1926.



**Supersonic Transformers.**—

Full particulars of some of the transformers used in the experimental work are set forth in Table I.

TABLE I.  
CONSTRUCTIONAL DATA FOR IRON-CORED TRANSFORMERS.

Transformer.	Windings.		Turns Ratio.
	Primary (Inner).	Secondary (Outer).	
No. 1	6 sections each 50 turns, 42 D.S.C.	6 sections each 150 turns, 42 D.S.C.	3 : 1
No. 2	6 sections each 50 turns, 42 D.S.C.	6 sections each 200 turns, 42 D.S.C.	4 : 1
No. 3	6 sections each 150 turns, 46 D.S.C.	6 sections each 660 turns, 46 D.S.C.	4.4 : 1

Details of Core. { Thickness of pure iron sheet = 1.5 mils.  
Effective mean length = 12.5 cm.  
Cross-sectional area = 1 sq. cm.

**Theoretical Considerations.**

In all matters pertaining to electrical apparatus, it is advisable to ascertain whether the experimental results are in agreement with theoretical considerations. If theory and practice are in harmony, there is a nucleus for design, provided, of course, no radical departure is made from the conditions under which the data was secured. Fig. 4 (a) illustrates the original valve circuit with supersonic transformer, whilst Fig. 4 (b) shows an equivalent arrangement. Again, Fig. 4 (c) shows a simplification of the latter arrangement at the resonance frequency. Taking Fig. 4 (b), the valve and H.T. battery are replaced by an alternator and an inductionless resistance  $\rho$  equal in magnitude to the internal resistance of the valve. The transformer is replaced by an inductance  $L_1$  equal to the effective inductance of the primary under

resistance valve. The equivalent capacity  $C_s$  is chiefly due to the necessity for a current in the primary winding required to balance the magnetisation owing to capacity currents arising from the self-capacity of the secondary and the mutual capacity between primary and secondary.

It can be shown that, at resonance, since  $\rho$  is virtually in parallel with the  $L_1 C_s$  combination, its effect is approximately equivalent to that of a resistance of magnitude  $\frac{L_1}{C_s \rho}$  in series with  $L_1$ . Hence at resonance, neglecting the leakage  $L_2$ , the circuits of Figs. 4 (b) and 4 (c) are equivalent.

$$\text{The value of } R \text{ is the sum of } r_e \text{ and } \frac{L_1}{C_s \rho} = \left[ r_e + \frac{L_1}{C_s \rho} \right].$$

$r_e$  is measured, of course, under operating conditions, as will be shown in a subsequent section. The class of circuit illustrated in Fig. 4 (c) is well known to everyone. Taken by itself, the selectivity curve has the familiar inverted "v" form, as shown by the various amplification curves which will be given in Part II.

In computing the amplification curves from known data, it is preferable to use the circuit of Fig. 4 (b), especially for frequencies remote from the resonance point, in order to attain a higher degree of accuracy. The theory of this circuit need not be discussed here. It will be sufficient to deal with the formula for amplification at the optimum wavelength. This is, as follows:—

$$\text{Combined magnification of valve and trans-} \left. \begin{array}{l} \text{former at optimum wavelength} \end{array} \right\} = \frac{Sm}{1 + \frac{\rho C_s r_e}{L_1}}$$

where  $S = \frac{n_2}{n_1}$  = ratio of turns.

$m$  = magnification factor of valve, as measured with transformer.

$\rho$  = internal resistance of valve, as measured with transformer.

$r_e$  = effective resistance of primary, as measured in valve circuit.

$C_s$  = effective capacity of primary, as measured in valve circuit.

Clearly the effective step of the transformer is:

$$\frac{S}{1 + \frac{\rho C_s r_e}{L_1}}$$

so that the combined influence of valve resistance and iron loss (chiefly) is to reduce the step in the ratio  $\frac{r}{1 + \frac{\rho C_s r_e}{L_1}}$ . Thus either a valve of high internal re-

sistance or a transformer of large effective resistance will have a profound influence in reducing the step, especially if the primary inductance  $L_1$  is small. Moreover, to attain high amplification with a valve of large internal resist-

ance, the ratio  $\frac{C_s r_e}{L_1}$  must be kept low. Now, for any

given optimum wavelength, the values of  $C_s$  and  $r_e$  are reduced by using thin iron of high resistivity and high differential permeability, since these give low loss and large inductance. Although the results attained with 1.5 mil iron are quite satisfactory and in accordance with

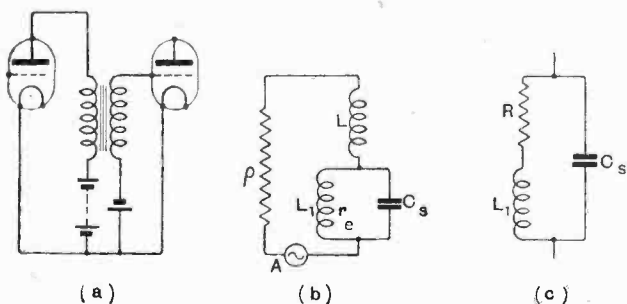

Fig. 4.—Equivalent circuits of iron-cored H.F. transformer.

operating conditions, shunted by a condenser  $C_s$  equal to the effective primary capacity. The inductance  $L_1$  possesses an effective resistance  $r_e$  at the resonant frequency. External to these there is an auxiliary inductance  $L$  equal in value to the equivalent leakage of the transformer. In the neighbourhood of the optimum wavelength,  $L$  may be left out of account, since it is only about 4 per cent. of the value of  $L_1$ . There is a resonance between  $L$  and  $C_s$  at a higher frequency, but, owing to resistance effects (valve partly), the peak is flattened out even with a low-

**Supersonic Transformers.**—

theory, it is possible to design superior transformers provided the materials just specified were available, say, with a differential permeability of eight to sixteen times that obtained in the tests described herein. For any given optimum wavelength the value of  $C_s$  would decrease substantially owing to the smaller windings necessitated in virtue of the greater inductance. If the value of  $\frac{r_e}{L_1}$  were smaller, or even of the same order as before, the effective step would be enhanced. In this argument we have overlooked one point, namely, the use to which these transformers is to be put. For telegraphy at moderate speeds of 250 words per minute, the necessary band frequencies are certainly not more than +600 to -600, so that the peak of the amplification curve can be relatively sharp. But in telephony there is a limit to the sharpness of the peak, and this imposes restrictions upon

possible, *i.e.*,  $\frac{C_s}{L_1}$  must be very small. This might be effected by the judicious use of "Mumetal," a material with high initial permeability, care being taken to avoid saturation.<sup>2</sup> Alternatively, the cross-section of the 1.5 mil iron could be increased. In this direction there is obviously a limit to avoid excessive bulk and D.C. resistance.

Another factor of importance associated with the flatness of the curve is the effective primary resistance  $r_e$ . A large value of  $r_e$  means a flat top, but this is secured at the expense of reduced amplification, since the alternating current through the primary which magnetises the core is reduced.

Moreover, at any given wavelength, when we have designed a transformer with the smallest possible  $\frac{C_s}{L_1}$ , and the curve does not possess the desired degree of flatness, it is necessary to compromise by using a valve of lower internal resistance. This is the presentation of the problem of the most efficient transformer.

The performance of a transformer depends on the load across the secondary due to the capacity of the next valve and the impedance in its anode circuit. The data which follow are not for the transformer *per se*, but for a "loaded" transformer. The result is an augmented  $C_s$ , an increased  $\lambda$  and an alteration in the amplification curve. This will be treated separately at a later date.

It is of interest to offer a simple explanation for the falling off in amplification on either side of the optimum wavelength, as shown in

some of the curves given hereafter. With a valve of high internal resistance and a transformer of *relatively* low inductance and moderate capacity, *e.g.*, the transformers described herein, at frequencies below resonance the inductive reactance is small, and at frequencies above resonance the capacity reactance is small compared with the valve resistance. Thus at such frequencies the greater part of the alternating voltage in the primary circuit is expended across the valve with a consequent diminution in magnification.<sup>3</sup> Hence the peak in the amplification curve.

<sup>2</sup> With a feed of 2 milliamperes the ampere turns per cm. in a transformer of present type with 100 turns primary is only 0.016.

<sup>3</sup> See "Speech Amplifier Design," *The Wireless World*, January 27th, 1926.

*Part II. will deal with the measurement of transformer magnification curves and valve coefficients.*

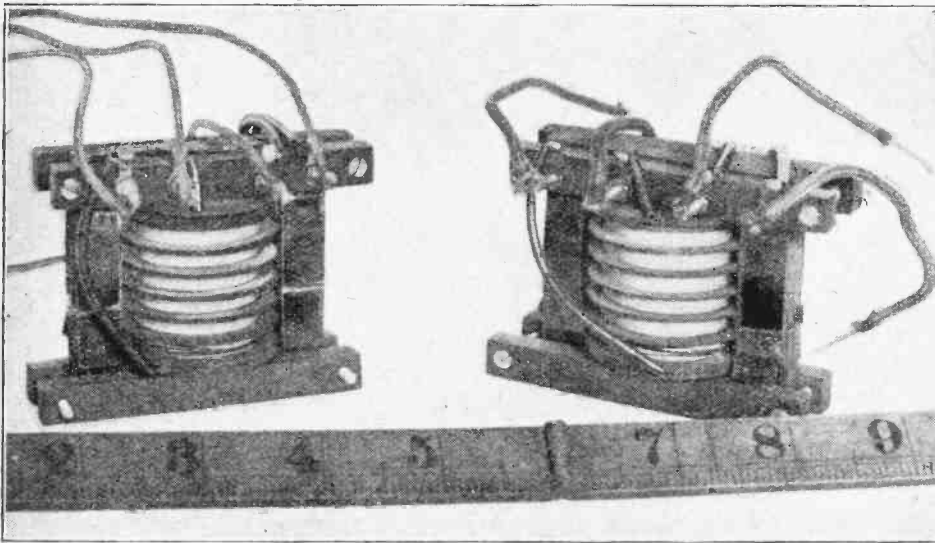

Experimental iron-cored supersonic transformers.

(a) the design of the transformer, (b) the internal resistance of the valve. The peakiness becomes more important when two or more transformers are valve-coupled in cascade. Now, with any valve the smaller the value of  $\frac{C_s}{L_1}$  the flatter the top of the amplification curve. Thus in order that an adequate band of side frequencies shall be amplified to a similar extent, the quantity  $\frac{C_s}{L_1}$  has an upper limit. The greater the internal resistance of the valve the smaller must be the value of  $\frac{C_s}{L_1}$  to give a desired degree of flatness to the amplification curve. This argument will be seen in concrete form by reference to the amplification curves taken with various valves and transformers.

The main issue, therefore, is identical with that in the design of audio-frequency transformers, namely, to secure as high an inductance and as low a capacity as

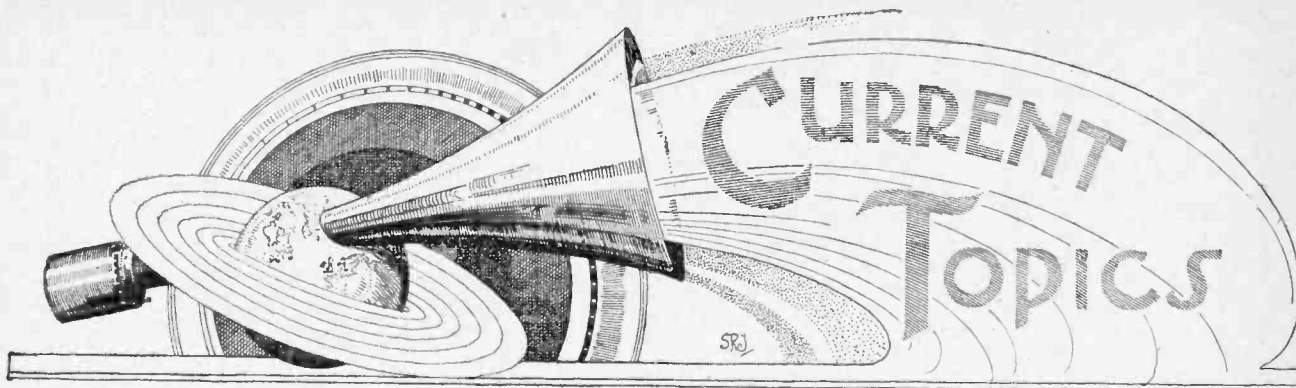

News of the Week in Brief Review.

**A MENTAL AMPLIFIER.**

"Radio is making the ten-year-old boy the intellectual superior of adults of other days."—Lt.-Gov. Fred A. Sterling, in opening the Chicago Radio Show.

o o o o

**BIRMINGHAM SHOW SUCCESS.**

The success of the Birmingham Wireless Exhibition was such that a similar show will probably be an annual event. Approximately 22,000 people passed through the turnstiles.

o o o o

**BRAVO, FREE STATE.**

Mr. J. Walsh, Free State Minister for Posts and Telegraphs, in opening the Dublin Wireless Exhibition last week, said that within fifteen months every home in the Free State would be brought within crystal range.

o o o o

**LET YOUR FRIENDS LISTEN—EARLY!**

Complaining that the acute shortage of gas in Lymm, Cheshire, is partly due to the popularity of broadcasting, Councillor R. Barker, chairman of the Urban District Council, has issued an appeal to local listeners-in to "deny themselves half an hour of broadcasting, and to go to bed at 10.30 p.m. instead of at 11 p.m."

o o o o

**WORSE THAN EUROPE?**

New York is suffering from a glut of interference on the broadcasting wavelengths. This is hardly surprising, considering that the N.Y. area contains at least 48 broadcasting stations. The confusion has increased since July, when a legal ruling deprived the Secretary of Commerce of any authority in regulating broadcast wavelengths.

o o o o

**WIRELESS ON FRENCH RAILWAYS.**

Once more in the matter of wireless communication British railways have been outstripped by foreign lines. The French Nord Railway has installed at Lille station a wireless transmitter and receiver which will enable communication to be maintained uninterruptedly with all the principal stations of the system at periods of telegraph breakdowns. Other French lines will probably follow suit.

**CABLES AND THE BEAM.**

The efficiency of the beam wireless service and of a new Atlantic cable have given rise to the rumour that in the near future Transatlantic cable rates will be reduced.

o o o o

**DANGEROUS GROUND.**

A Danish newspaper prints 5WA's programme under the heading "England." This is bound to annoy Cardiff, but one can be thankful that Aberdeen was omitted.

**AMERICAN GEAR IN DENMARK.**

Danish listeners are reported to be making extensive use of American receiving apparatus. The number of imported sets is increasing, but British and German receivers are stated to be distinctly in the minority. The neotrodyne is very popular.

o o o o

**WIRELESS OFFICER'S PROMOTION.**

Major B. C. Gardiner, C.B., who was Fleet Wireless Officer on the staffs of Admirals Jellicoe and Beatty during the war, has been promoted to Lieut.-Col. He was made a C.B. on the break-up of the Grand Fleet in 1919, and afterwards became head of the Wireless Telegraphy Board.

o o o o

**PRAISE FOR BELFAST STATION.**

Satisfaction with the services of the Belfast broadcasting station was expressed at the second annual dinner of the Ulster Wireless Traders' Association, held on October 27th. The president, Mr. L. Scop, who occupied the chair, said: "I feel sure that the Northern Government has done as much as any Government could in connection with broadcasting. We have certainly got a station as good as any in England."

o o o o

**NEWS FROM BOMBAY.**

General satisfaction is felt in India, writes a Bombay correspondent, over the appointment of Mr. Eric Dunstan as general manager of the Indian Broadcasting Company. In Calcutta the company plans to erect a station in the Cossipore-Chippori Park, while in Bombay the chosen site will probably be in the West India Turf Club Park. This is in a central position, and will probably permit of crystal reception in any part of the island of Bombay. Moreover, it is far removed from sources of disturbance such as electric railways and power stations.

o o o o

**COMPLETION OF HOSPITAL WIRELESS SCHEME.**

By invitation of the Lord Mayor, a luncheon was given at the Mansion House on Tuesday, November 2nd, to celebrate the completion of the equipment of Lon-



**THE IDEAL COMBINATION.** A side-car containing a multi-valve receiver, seen at the recent Berlin Motor Show. It would appear that the passenger has few opportunities of surveying the scenery.

**BROADCASTING ACTIVITY IN U.S.**

The United States still possess three-fifths of the world's broadcasting stations and five times the number of receiving sets in use in any other country, says the U.S. Department of Commerce, which adds that foreign countries are now waking up to the possibilities of radio. The United States is the only country in which the wireless enthusiast can listen in free of charge.

don hospitals with wireless through the fund raised by the *Daily News*.

Since the Fund was instituted in May, 1925, a total of 122 hospitals have been equipped with sets, together with 13,456 headphones and 479 loud-speakers. The total cost was just over £25,000.

The main purpose of the luncheon was to acknowledge the valuable assistance given by the *Daily News* in the organisation of the Fund by Lord Knutsford, the Advisory Council, the B.B.C. and its technical advisers.

Sir William Joynson-Hicks, proposing a vote of thanks to the *Daily News* and the Advisory Council, said that he had seen the joy and pleasure which had been given to unfortunate sufferers.

The proceedings closed with the presentation of a writing desk to Mr. Hugh Jones, of the *Daily News*, who originated the idea and was largely responsible for its development.

o o o o

#### SHIP'S WIRELESS RECORD.

What is probably a maritime wireless record has been made by the Australian steamer *Jervis Bay*, which has succeeded in maintaining wireless touch with the Penman Hill station, Sydney, throughout a 12,000-mile voyage from Australia to Plymouth.

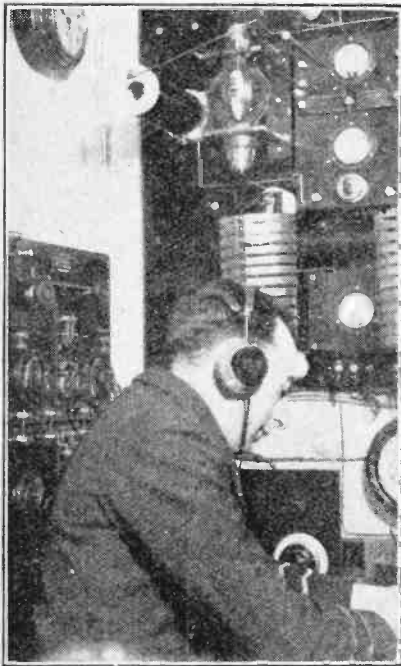

**SHIP'S WIRELESS RECORD.** Mr. Victor Brooker, chief wireless operator on the "Jervis Bay," which maintained communication with Sydney throughout its 12,000-mile voyage from Australia to England.

#### A PERUVIAN PUSH.

Peruvian wireless dealers and manufacturers are discovering that lowered prices are stimulating a boom in radio apparatus. An effort is being made to increase the sale of British-made sets.

#### THE WIRELESS UNIVERSITY.

"A Wireless University would in no sense be a rival of existing universities, competing with them for students. Broadcast education would aim first and foremost at meeting the needs of ordinary men and women who have had little time

#### WIRELESS PROGRESS "DOWN UNDER."

The Amalgamated Wireless Company of Australia announces that all should be ready for the opening of the beam system between Australia and Great Britain early in the New Year. The British Marconi

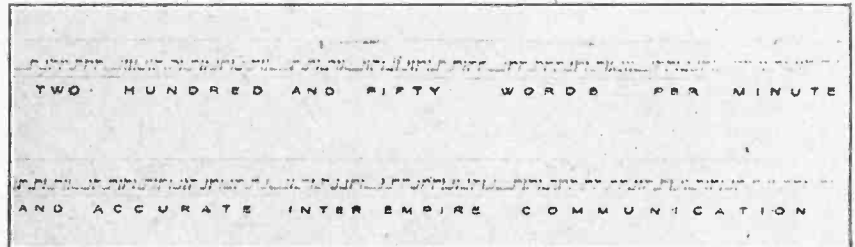

**250 WORDS PER MINUTE.** This photograph of a portion of a message received at high speed during the official tests of the beam wireless circuit between England and Canada shows the remarkable steadiness and accuracy achieved.

or opportunity to continue their education after they left school, and who feel a desire to know more about the world and the people in it."—Mr. J. C. W. Reith, managing director of the British Broadcasting Co., Ltd.

o o o o

#### A WORKING ARRANGEMENT.

Shareholders of the Marconi International Marine Communication Co., Ltd., have been informed that the company has recently come to a working arrangement with its principal competitor, the Radio Communication Company, whereby substantial reductions in expenditure are effected, together with an improvement in the service to ship-owners. The companies retain their separate entity in every way.

o o o o

#### ORPEN PORTRAIT OF PROF. FLEMING.

Dr. J. A. Fleming's distinguished services in the Chair of Electrical Engineering at University College for forty-two years are being recognised in signal fashion by the painting of a portrait, the artist being Sir William Orpen. The portrait will be placed in University College, a replica being given to Dr. Fleming himself, who wishes to offer it to the Institution of Electrical Engineers.

The Portrait Fund Committee is anxious to bring the Fund to a successful conclusion. Any gift, however small, will be acceptable. Subscriptions should be sent to Prof. W. C. Clinton, University College, London, W.C.1.

o o o o

#### SHORT-WAVE STATION AT ATHENS.

A wireless station with an all-European range is to be built near Athens for the Eastern Telegraph Company, who have entered into an agreement with the Marconi Company for the erection of the station. This move is the result of a special concession granted to the telegraph company by the Greek Government.

Using a power of 15 kilowatts, the station will operate on a wavelength slightly under 100 metres. Its average transmission speed will be between 60 and 70 words per minute.

Company's engineer, who superintended the erection of the Canadian beam stations, has arrived in Sydney.

After a period of successful working, the Amalgamated Wireless Company reports a net profit of £12,190 for the year ended June 30, as against £5,030 for the previous year. The company has recently assumed control of the Government coastal stations, and besides doing a big business with ships at sea, operates services to New Guinea and New Caledonia.

o o o o

#### ITALY'S PRIDE.

On the opening of the Canadian beam service Senatore Marconi received the following telegram from Signor Mussolini:—

"Permit me, in the name of the Fascist Government, to express to you, with the sentiments of the Italian people, my own feelings of profound and affectionate admiration upon your discovery, which will cause to shine throughout the world the fame of Italian genius and the honour of the Roman civilisation."

o o o o

#### WIRELESS WEEK AT MAIDSTONE.

All wireless enthusiasts in Kent should take note of the fact that next week is Maidstone's Radio Week. Under the auspices of the Maidstone and District Radio Society the town's Fourth Annual Wireless Exhibition will be held in the Concert Hall, Corn Exchange, from November 16th-20th.

A competition has been arranged, open to all without entrance fee, for the best home-constructed 1-, 2-, 3- and 4-valve sets. Entry forms may be obtained from Mr. H. T. Cogger, 44, Postley Road, Maidstone, the closing date for entries being Friday next, November 12th.

o o o o

#### A CORRECTION.

In the article describing the "Economy Two" receiver, in *The Wireless World* for October 27th, 1926, it was stated that a Cosmos D.E.55 Blue Spot valve was suitable. The correct designation of this valve is "S.P.55 Blue Spot." We may add that the corresponding valves in the Benjamin and Amplion ranges are equally suitable.

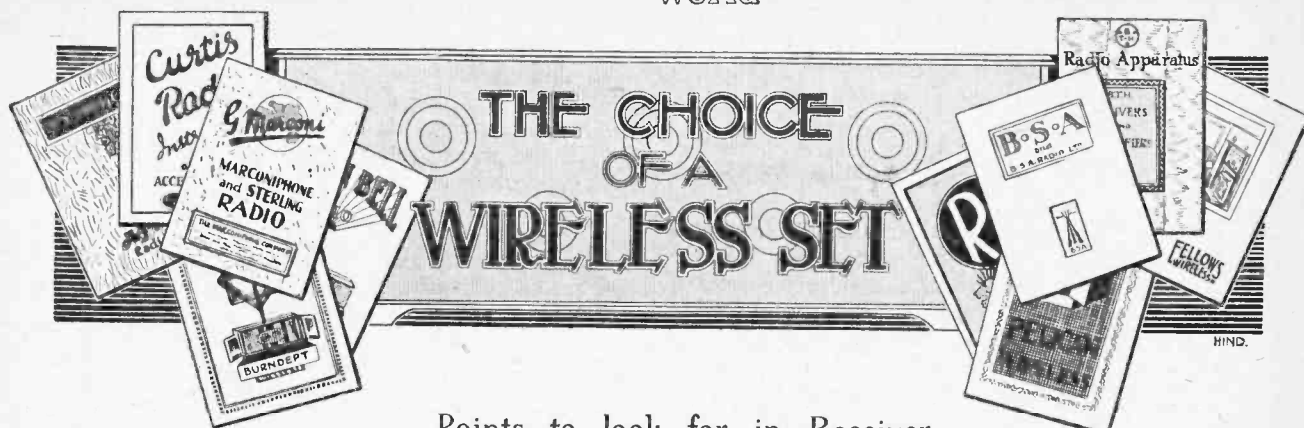

## Points to look for in Receiver Design, and a Preliminary Announcement regarding Forthcoming Tests.

TO give advice on the choice of a receiving set is impossible without exact knowledge of the conditions under which the receiver is to be used. There are so many incalculable factors influencing the final result. For instance, wireless waves do not radiate in concentric circles, with the transmitting station as centre, as the writers of simplified wireless theory would have us suppose; "blind spots" abound, and it is impossible to say how many stations may be heard at a given place and in what relative strength without actually listening-in at that place. Then there is the efficiency of the aerial to consider; however shrewdly one may attempt to estimate this from a sketch showing the height, length, and spacing from neighbouring objects, there is nearly always some unforeseen factor, moisture in the lead-in tube, a broken strand in the wire, or a bad earth, which will entirely upset the most careful estimate. Finally, there is the possibility of unexpected local interference.

Let the dealer view your premises and ask him to indicate the best type of aerial which it is possible to erect in the circumstances, taking special note of precautions he is sure to urge upon you regarding insulation and spacing of the down lead away from the wall. The aerial having been erected, you may invite him to test its efficiency with a standard receiver the performance of which, under normal conditions, is well known. From the results obtained it should not be difficult for him to specify the type of receiver required. The final choice among receivers in the class specified will naturally be decided according to cost and individual taste.

Not every potential buyer, however, can call upon the services of a competent dealer or the help of a friendly wireless enthusiast. It may, therefore, be worth while to indicate the natural groups into which receivers fall and to give some idea of the type of performance characteristic of each group.

### The Crystal Set.

The crystal set is representative of the simplest group of wireless receivers, viz., receivers in which the sole source of sound in the telephones is the energy collected by the aerial. The principal component is the detector or rectifier, which converts the energy from the aerial to a form suitable for creating sounds in the telephones. The detector either in the form of a crystal or valve is an essential of every receiving set, and forms the nucleus around which every receiver, of no matter what type, is built. The crystal set represents the irreducible minimum of the essentials necessary for wireless reception.

Since no means is employed of amplifying or supplementing the energy picked up on the aerial, it follows that the crystal set must necessarily be insensitive. With a good outdoor aerial satisfactory results may be expected within a radius of 10 miles of a B.B.C. main station or 50 miles of Daventry, provided that there are no nearby stations working on adjacent wavelengths. The crystal set is unselective in the extreme, and prone to interference unless the waves from the local station are far more vigorous than any others reaching the neighbourhood. It would be unfair to leave these indictments of the crystal set unbalanced by praise of the many good points in its favour; it is the cheapest set to buy in the

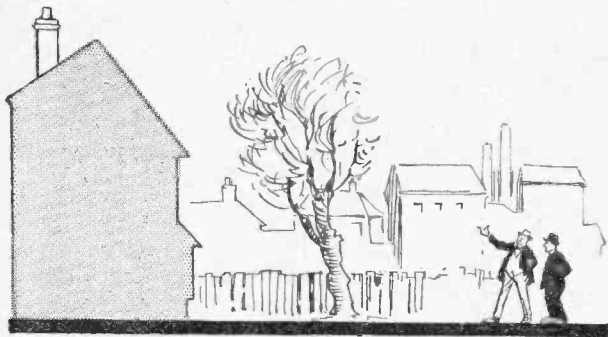

"Get expert advice on the erection of an efficient aerial."

The only safe thing to do is to consult the local wireless dealer—that is, assuming he has established a good reputation in the neighbourhood and has a high percentage of satisfied customers among his *clientèle*. His knowledge of local conditions, gained from installing numbers of sets under all sorts of circumstances, will enable him to tell you at once what you may reasonably expect to receive and how much it will cost.

After the preliminary talk and *before* buying your set get expert advice on the erection of an efficient aerial.



**The Choice of a Wireless Set.—**

first instance, costs nothing to maintain, and, with good headphones, gives reproduction of superlative quality.

**Valve Detectors.**

Although not strictly analogous, one may class with the crystal set the single valve set without reaction. The selectivity is slightly better, there is a slight amplification of energy during the detecting process, and it is not necessary to make frequent adjustments during reception. These qualities alone, however, do not justify the higher initial and maintenance costs of batteries, and consequently this type of receiver is not common; nearly all single-valve sets at the present time make use of reaction.

**Reaction.**

Like fire, reaction is a good servant but a bad master. By using it in a single-valve set not only can we increase the range on the local station and Daventry from 10 miles and 50 miles to at least 30 miles and 150 miles, respectively, but it will be found possible to cut out interference from other stations in a manner not possible with the plain valve detector. The handling of a reacting single-valve set requires some skill, however, if serious interference with neighbouring sets through oscillation is to be avoided. It takes about as long to get the feel of a reacting receiver as it does to learn the controls of a car, so there are no insuperable difficulties.

**H.F. Amplification.**

Oscillation sets the limit to the range-increasing powers of reaction, and the use of high-frequency amplifying valves before the detector is essential for further extension of the range and selectivity of a receiver. High-frequency valves can also be made to take the place of reaction, as in the case of "Neutrodyne" receivers, which are perfectly free from self-oscillation and cannot cause interference even when mishandled. Except in the case of "single-valvers," it is probable that reaction will be superseded in all broadcast receivers by the use of efficient H.F. amplifiers.

On an average aerial a detector valve, with or without reaction, preceded by a single high-frequency amplifying valve efficiently designed should bring in all the principal British and European broadcasting stations. Two stages of H.F. amplification should only be necessary when using an inferior aerial or when extreme selectivity is required to eliminate unusually severe interference.

**Low-frequency Amplification.**

It will be noticed that no mention has been made of loud-speakers. This is because we have so far been intent on getting the right kind of results at the detector valve with headphones. Having satisfied ourselves on this point it is quite a simple matter to increase the volume of sound to any required level by the addition of low-frequency amplifying valves. These valves do not affect the range and selectivity of a receiver; they merely increase volume.

A single L.F. valve will generally suffice to work a small table loud-speaker and two valves, transformer coupled, will give more than enough volume for all ordinary requirements.

**Super Sets.**

In this category we may place super-heterodynes and multi-stage H.F. amplifiers for use with frame aerials or for extreme ranges. It is not proposed to deal with this class in the present article, which is intended to deal only with the requirements of the average listener.

**Sundry Advice.**

The question of cost is bound to involve compromise and the sacrifice of some part of our programme. Listeners in Devon and Cornwall, Norfolk and Lincoln, North and Central Wales are advised to concentrate on Daventry.

In country districts it is asking for trouble to stint in the matter of batteries, particularly the H.T., which should be of large capacity—valves, too, should be of well-known and well-tried make.

Musicians with an appreciation of good quality reproduction should concentrate on headphone reception unless they are prepared to buy the best of everything in the matter of L.F. transformers, power valves, loud-speaker and a large capacity H.T. battery of not less than 120 volts. They should also concentrate on stations which are well above the atmospheric level in strength; long-distance reception is not much to listen to from a musical standpoint.

**—The Final Choice.**

The foregoing should enable the reader to decide for himself into which category his requirements may be placed and the type of receiver which will meet them, remembering that H.F. valves give range and selectivity, L.F. valves volume.

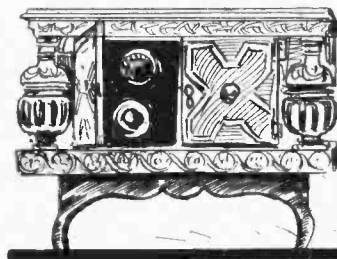

... "Would look out of place on the Chippendale."

All he has to do now is to pick out from the "Buyers' Guide" the odd dozen or so conforming to the required specification, make a selection of those falling within his price limit and write off to the makers for catalogues. A first glance will eliminate half of these; this one is "all knobs," that one would look out of place on the Chippendale table he has set aside for it, a third has no provision for Daventry—and so on.

The final and most difficult process is the elimination of those half-dozen makes which all appear to be equally suited to his needs. The only solution is a comparative test, but this is impracticable unless your dealer carries a sample of each make, which will be most unlikely unless he is in a very big way of business.

**"The Wireless World" Tests.**

To help the reader in this difficulty we are arranging to test examples of representative types of receiver and

**The Choice of a Wireless Set.—**

to review them in the pages of this journal in the same way that valves and other components are dealt with in their appropriate sections.

An appreciation or criticism will be made on each of the following points:—

(1) SENSITIVITY, i.e., overall amplification between aerial circuit and output to phones or loud-speaker.

The sensitivity of a receiver determines its range of



"The only solution is a comparative test."

reception, and a list of stations will be given indicating the range under normal conditions.

(2) SELECTIVITY, i.e., ability to separate stations adjacent in wavelength.

In order to get some idea of selectivity each receiver will be tested at two places, one in close proximity to a main broadcasting station and the other at a distance of about 15 miles.

There will also be a test to ascertain the amount of pick-up in coils and wiring; a factor directly influencing selectivity at close ranges.

(3) STABILITY, i.e., of tuning, reaction and neutralising adjustments with small changes of battery voltage, change of hand capacity, etc.

(4) COST OF RUNNING.

This is related to the H.T. and L.T. current and the number of valves (replacements).

(5) EASE OF OPERATION.

(6) EASE OF ERECTION.

Possibility of wrong connections and short circuits.

(7) WORKMANSHIP.

Mechanical strength of components, wiring joints, etc.

(8) FINISH AND APPEARANCE.

In addition there will be general comments on any unique features of design, quality of reproduction, probable reliability as inferred from (3), (6) and (7) and other features which it is difficult to classify.

**Bowyer Lowe "Radio News."**

The current number of the Bowyer Lowe "Radio News," besides containing prices and details of the firm's sets and components, includes an interesting article on the super-heterodyne and constructional hints on assembling a four-electrode valve portable receiver. Copies are obtainable from the Bowyer Lowe Co., Ltd., Radio Works, Letchworth.

**Off Duty.**

The doctor hurried into a restaurant and sat down at a side table. A languid waitress plumped down the menu in front of him and announced: "Boiled tongue, stewed kidneys, fried liver—"

The M.D. interrupted her. "Never mind your symptoms," he said. "Let's have something to eat."—Cossor's *Radio Mail*.

**Logging Distant Stations.**

The General Electric Co., Ltd., have produced a neat little folder (2½" x 2½") whereby the wireless user can record particulars of his distant stations. This is being enclosed in all 40-watt and 60-watt Osram Lamp cartons throughout the present lighting season. This folder also contains information on the correct Osram Valves to use, and gives valve combinations.

**Exide Expansion.**

The latest evidence of the expansion of the Exide business is the removal of the distributing depot in Manchester from No. 1 to No. 18, Bridge Street.

The main function of these depots, which exist now in London, Birmingham, Bristol, Manchester and Glasgow is the decentralisation of stores. Although the works at Clifton Junction has been in-

**TRADE NOTES.**

creased to many times its original size, it is impossible to carry out direct distribution of the small types of batteries without undue delay.

The new premises comprise showrooms, offices and storerooms, with a total floor space of over 400 square yards, and a window frontage of 74 feet. The storerooms are fitted with every modern equipment for the easy storage and rapid handling of batteries.

**Wireless Van Competition.**

The result of the Wireless Demonstration Van Competition, in which competitors had to estimate the number of miles covered by the van during its recent tour, is published by the promoters,

**"WIRELESS WORLD"  
CONSTRUCTIONAL ARTICLES**

To appear in early issues.

**Combined Loud-Speaker Receiver.**

A broadcast set where the loud-speaker is included in the receiver cabinet.

**General-Purpose Valve Wavemeter.**

An instrument indispensable in long range reception.

**"Everyman's 5-valve Receiver."**

A screened 2 H.F. set in this famous series.

**A Portable Frame-Aerial.**

A general purpose frame of simple construction.

Messrs. A. Graham, Ltd., Mullard Wireless Service, Ltd., and Automobile Accessories (Bristol), Ltd.

The van actually covered 4,342 miles, the figure of 4,346 being given by the first prize winner, Mr. N. Spence, of Honiton, who receives an A.R. 19 Amplion 5 gn. loud-speaker. Five second prizes of P.M. Mullard valves have been won and fifty third prizes consisting of P.D. lightning arresters.

**"Hart" Batteries for Beam Service.**

The Bodmin beam station for communication with Canada is equipped with Hart accumulators. It is interesting to note that batteries of this make were used in the earliest beam experiments, conducted by the Marconi Company at Hendon about six years ago.

**Houghtons' Radio News.**

This "live" little periodical, now published monthly, contains illustrated descriptions of newly introduced radio apparatus and accessories and other matters of assistance to the radio dealer. It is produced by Houghton-Butcher (Great Britain), Ltd., 88-89, High Holborn, W.C.1.

**A Royal Visit.**

Redfern's Rubber Works, Ltd., of Hyde, near Manchester, the makers of Ebonart radio panels, recently received the honour of a visit from H.R.H. Princess Helena Victoria, G.B.E., who inspected the company's products in the various stages of manufacture. Touring through the different departments, the Princess observed the mixing of the rubber and the ensuing operations in the manufacture of Ebonart panels and other ebonite goods.

# NEWS FROM THE CLUBS

Secretaries of Local Clubs are invited to send in for publication club news of general interest. All photographs published will be paid for.

## Brighter Wireless Theory.

The reading of a war-time treatise on "Theoretical Principles of Wireless Telegraphy" caused much amusement at the last meeting of the Bristol and District Radio Society. The work, which is a skit on certain official wireless manuals, includes many lurid circuits incorporating such unusual components as sewing machines, bedsteads, and water taps.

The weekly valve ballot was won by Mr. Bundy.

The hon. secretary is Mr. S. J. Hurley, 46, Cotswold Road, Bedminster, Bristol.

## Aircraft and Artillery Wireless.

Wartime wireless was dealt with in a fascinating manner by Mr. E. Beat, ex-R.A.F., in his lecture before the City of Belfast Y.M.C.A. Radio Club on October 22nd. Of special interest was the description of the systems employed by aircraft for signalling instructions and information to the artillery during bombardments.

The club's Morse class is now in full swing, nearly all the members taking part.

Hon. secretary: Mr. John J. Cowley, 4, St. Paul's Street, Belfast.

## Secretaries, Please Note.

Messrs. Siemens Brothers, of Woolwich, S.E.18, inform us that they have now arranged an attractive programme of lantern lectures dealing with the manufacture, choice, and care of dry batteries.

## Maidstone Radio Week.

Under the auspices of the Maidstone and District Radio Society the fourth annual wireless exhibition will be held in the Concert Hall, Corn Exchange, Maidstone, from November 16th to 20th inclusive. An open competition has been arranged, without entrance fee, for the best home-constructed 1-, 2-, 3- and 4-valve sets. Entry forms may be obtained from the hon. secretary. Closing date: Friday, November 12th.

The society holds weekly meetings at 8 p.m. on Fridays at the Oddfellows' Hall, King Street. An excellent programme has been prepared for the coming months, and full particulars are obtainable from the hon. secretary, Mr. H. T. Cogger, 44, Postley Road, Maidstone, Kent.

## A Tale of Two Sets.

Mr. J. E. Nickless, A.I.E.E. (2KT), presiding at the last meeting of the South Woodford and District Radio Society,

spoke in eulogistic terms of the "Grebe Synchrophase Five," which was demonstrated by Mr. Ostermeyer. This well-known American receiver employs a gang condenser and binocular coils wound with Litz. At South Woodford 2LO was tuned in on a 20 ft. ex-Government earth mat, without aerial connection, at overpowering strength. On the club's aerial English, French, German, Spanish, and other stations unidentified were put on the loud-speaker at unexpected strength despite atmospherics.

By way of variety Mr. Nickless demonstrated a three-valve, self-contained portable receiver, which gave good loud-speaker results on the local station. The latter receiver had worked well the same evening in the guard's van from Liverpool Street to Woodford, much to the delight of the passengers!

Hon. secretary: Mr. E. J. Turbyfield, 42, Alexandra Road, South Woodford, E.

## Gramophones and Loud-speakers.

By the courtesy of the directors of Edison Bell, Ltd., members of the Croydon Wireless and Physical Society recently paid a visit to the Edison Bell

factory at Glengall Road, London, S.E. After witnessing a demonstration of gramophone record manufacture, the party were conducted over the radio show-room, where they listened to broadcast reproduction on a loud-speaker designed by Mr. P. G. A. H. Voigt. This instrument greatly impressed the visitors by reason of its purity and richness of tone, particularly in the reproduction of organ pedal notes.

Particulars of the society will be gladly furnished by the hon. secretary, Mr. H. T. P. Gee, A.M.I.E.E., Staple House, 51 and 52, Chancery Lane, London, W.C.2.

## "Superhet" History and Development.

On October 21st Dr. Morgan lectured to the Golders Green and Hendon Radio Society on the super-heterodyne. He opened with a brief history of this type of receiver, and traced its development. Its chief advantages, he said, were sensitivity and selectivity, and he raised an interesting point when he claimed that the "mush" so often brought in by these sets was due to the frame aerial.

Hon. secretary: Lt.-Col. H. A. Scarlett, D.S.O., 357a, Finchley Road, N.W.11.

## Sheffield Society's New President.

The new president of the Sheffield and District Wireless Society, Mr. R. Jakeman, who has taken a keen interest in the society for many years, was hon. secretary during the period 1924-25.

New features are being introduced into this year's syllabus, one of which consists of a monthly review of the latest developments of wireless throughout the world. Papers on various aspects of radio engineering will be given fortnightly, and arrangements are being made for an exhibition of members' apparatus to be held early in the New Year.

Hon. secretary: Mr. T. A. W. Blower, 129, Ringinglow Road, Sheffield.

## Transmission Tips.

A mass of useful information on "Transmission" was provided by Mr. J. C. Bird, B.Sc. (G 2JB) in his lecture on the subject at the last meeting of the Muswell Hill and District Radio Society. Useful circuits, among which were the Colpitts and the Hartley, were drawn on the blackboard, and the lecturer supplied valuable data regarding coil dimensions, besides many useful tips on transmitter construction and operation.

Hon. secretary: Mr. Gerald S. Sessions, 20, Grasmere Road, Muswell Hill, N.10.

## FORTHCOMING EVENTS.

### WEDNESDAY, NOVEMBER 10th.

Muswell Hill and District Radio Society.—At 8 p.m. At Tollington School, Tetherdown. Demonstration of Peto-Scott 6-Valve Unit-Control (Screened Coil) Receiver.

Edinburgh and District Radio Society.—At 8 p.m. At 117, George Street. Short-wave Night.

Barnsley and District Wireless Association.—At 8 p.m. At 22, Market Street. Lecture: "Soldering, and Other Practical Hints," by Mr. G. W. Wigglesworth.

Wireless and Experimental Association.—At 8 p.m. At the Cumberwell Central Library. Lecture and demonstration on the Marconi "Straight Eight."

### FRIDAY, NOVEMBER 12th.

Leeds Radio Society.—At 8 p.m. At Colton's Cafe, Wellington Street. Lecture: "More About Electricity," by Mr. D. C. Field, B.A.

Radio Experimental Society of Manchester.—Lecture: "Neon Tubes and Their Various Uses," by Dr. Ramsden. Sheffield and District Wireless Society.—The Month's Wireless News, by E. W. Cross.

### MONDAY, NOVEMBER 15th.

Croydon Wireless and Physical Society.—At 8 p.m. At 128a, George Street. Lecture: "Elementary Wireless," by Mr. C. Creswick, Albinson, A.I.R.E. Southport and District Radio Society.—At St. Andrew's Hall, Part Street. Review of the Latest Components.

### THURSDAY, NOVEMBER 18th.

Golders Green and Hendon Radio Society.—At 8 p.m. At the Club House, Willisfield Way, N.W.11. Demonstration: "Wireless Picture Transmission," by Mr. F. H. Hayes, Assistant Editor, The Wireless World.

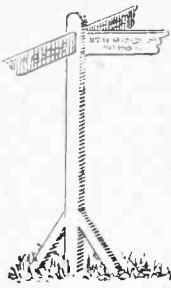

# The Wireless World BUYER'S GUIDE

## INDEX TO SETS ON THE MARKET



SO many developments have taken place in the manufacture of receivers since the publication of *The Wireless World Buyer's Guide* in our issue of February 10th, that, encouraged by the very favourable reception given to these lists by our readers, we are now bringing out a revised list grouped as before under the headings of Crystal Sets, Crystal Valve Sets, Valve Sets, Amplifiers and Portable Sets.

We feel that the present moment is particularly opportune for the publication of this "Buyer's Guide," since the date of the appearance of our issue is in the middle of National Wireless Week, which is attracting so much attention at present. The slogan of National Wireless Week is "Let Your Friends Listen," and the object is to endeavour to widen the circle of

wireless listeners so that there may be no home left without a wireless set as part of its equipment.

It is, of course, impracticable in compiling a list of this kind, where the space available for general descriptions and remarks is necessarily limited, to preserve absolute consistency throughout, especially as the information is derived from so many different sources, but we have endeavoured as far as possible to condense the description furnished by the manufacturers into a more or less stereotyped form so that a ready comparison may be made. We would, however, strongly urge upon our readers that, before selecting any receiver, they should obtain the full particulars which the manufacturers are always willing to supply.

### CRYSTAL SETS

Manufacturer.	Name of Set.	Type of Cabinet.	Price.	Description and Remarks.
British Thomson-Houston Co., Ltd., Crown House, Aldwych, London, W.C.2.	B.T.H. Bijou .....	Walnut box .....	£ s. d. 1 0 0	Set only. Loading device for 5XX, 3s. 6d. extra. Set only. Provided with alternative crystals and change-over switch. Loading device for 5XX, 3s. 6d. extra.
	B.T.H. Model A .....	Sloping panel .....	1 15 0	
Brownie Wireless Co. of Gr. Britain, Ltd., Nelson Street Works, Arlington Road, London, N.W.1.	Brownie .....	—	7 6	Complete with D.L.S. crystal.
	No. 2 .....	Solid moulding .....	10 6	
Climax Radio Electric, Ltd., Quill Works, Putney, London, S.W.15.	Climax Popular .....	—	12 6	Set only. Coil for 5XX, 3s. 6d. extra. Set only. Inclusive of 5XX range.
	Junior de Luxe .....	Mahogany case, ebonite panel.	1 1 0	
Hagle Engineering Co., Ltd., Warwick .....	Chakophone No. 4 .....	Mahogany box type ..	1 0 0	Set only. With aerial supplies and headphones. Set only.
	—	—	1 15 3	
	No. 3a .....	Hard wood box type with lid.	1 10 0	
Edison Bell, Ltd., 62, Glengall Road, Peckham, London, S.E.15.	Edison Bell .....	Oak, with closing lid ..	2 5 3	With aerial supplies and headphones. Set only. Variometer tuning, 280-1,600 metres. Nickel-plated fittings. Electric lighting under crystal twin detector with opal tubes.
	—	—	2 10 0	
Edison Swan Electric Co., Ltd., 123/125, Queen Victoria Street, London, E.C.4.	Ediswan W.L.1924 .....	Walnut, with moulded panel.	11 6	Set only. Tuned by variable condenser, with detachable loading coil, 280-500 metres. Nickel-plated fittings. Electric lighting under crystal twin detector with opal tubes. Set only.
	—	—	1 17 9	
	W.L.1924 L. ....	—	14 0	
	W.L.1924 P. ....	—	2 0 3	
Ericsson Telephones, Ltd., 67/73, Kingsway, London, W.C.2.	0/1050 Miniature .....	Watch pattern .....	7 6	Complete with accessories as above. 100/700 metres. but with plug to take loading coil. Set only, with loading coil. Complete with accessories as above. 100/700 metres and 5XX.
	0/1002 .....	Oak case, with lid .....	1 1 0	
Falk, Stadelmann & Co., Ltd., 83/93, Baringdon Road, London, E.C.1.	0/1002A .....	—	1 4 0	Provision for loading coil. Loading coil incorporated. Complete with aerial and earth equipment and 1 pair headphones.
	Benbow .....	Mahogany lift-up top and compartment for phones.	2 17 6	
	Junior .....	Mahogany slab cabinet	1 65 0	
Fallowfield, Jonathan, Ltd., 61/2, Newman Street, London, W.1.	Newman .....	Mahogany .....	2 0 3	Set only. Complete with aerial and earth equipment and 1 pair headphones. Complete with 2 pairs headphones and aerial equipment.
	—	—	3 3 0	
Garage, A. W., Ltd., Holborn, London, E.C.1	Ideal .....	Mahogany .....	3 5 6	Set complete with 1 pair headphones, lead-in tube, lightning switch, 100ft. aerial wire, 2 aerial insulators, 20ft. earth wire. Set only.
—	—	—	16 0	
General Electric Co., Ltd., Magnet House, Kingsway, London, W.C.2.	Gecophone Junior, No. B.C.1700.	Mahogany, open desk type, nickelled fittings.	16 0	Set only. Complete with 1 pair headphones and aerial equipment.
	B.R.C.1 .....	Oak, enclosed .....	1 5 0	
Henderson, W. J. & Co., Ltd., 351, Fulham Road, London, S.W.10.	—	—	2 10 0	Set only. Complete with 1 pair headphones and aerial equipment. Set only. Complete with 1 pair headphones and aerial equipment.
	B.R.C.2 .....	—	1 12 6	
	—	—	2 17 6	

# Buyer's Guide to Sets

CRYSTAL SETS—continued.

Manufacturer.	Name of Set.	Type of Cabinet.	Price.		Description and Remarks.	
			£	s. d.		
Holrose Manufacturing Co., 43, Lonsdale Road, Kilburn, London, N.W.6.	Holrose .....	Circular, leatherette covered.	8	6	Set only.	
"	" .....	Aluminium base .....	1	4	6	Complete with headphones, Daventry loading coil and aerial supplies.
Johnson, T. J., 17 and 19, Catherine Street, Salisbury.	Sarumphone Crystal .....	Mahogany box .....	1	0	0	
Lampugh, S. A., Ltd., King's Road, Tyseley, Birmingham.	No. 1030 .....	Oak .....	1	10	0	Set only. With plug for loading coil.
"	Junior .....	Ebonite moulding .....	9	6		" " Loading coil for Daventry, 3s. 6d. extra.
"	" .....	" .....	16	0		
Lissen, Ltd., Friars Lane, Richmond, Surrey	Lissen Crystal .....	Polished aluminium ..	1	7	6	Aerial supplies, 7s. 6d. extra.
M.A.P. Co., 216, Great Lister Street, Birmingham.	M.A.P. Crystal .....	" .....	1	7	6	
Metro-Vick Supplies, Ltd., 155, Charing Cross Road, London, W.C.1.	Cosmos .....	Circular moulded base ..	1	5	0	Set only. With plug-in coil for either B.B.C. or long wave band and enclosed detector.
Radiarc Electrical Co., Ltd., Bennett Street, London, W.4.	Liberty Midget .....	" .....	7	6		Set only.
"	Liberty Ironclad .....	" .....	16	0		"
Radiax, Ltd., 16, Palmer Place, London, N.7	Challenge .....	Mahogany case, with lid.	2	0	0	Set only. 100/1,600 metres.
"	" .....	Walnut, with lid .....	18	6		Variometer tuned. Daventry coil included.
Radio Supply Co., Superfone Works, Four Oaks, Birmingham.	Superfone .....	" .....	1	1	0	For local and Daventry.
Rawle Bros., Stamford Road, Handsworth, Birmingham.	Fireside .....	Oak .....	1	1	0	
Regent Radio Supply Co., 45, Fleet Street, London, E.C.4.	Regentone .....	Mahogany, lidded .....	2	2	0	Set only.
Service Radio Co., Ltd., 62, Church Street, Stoke Newington, London, N.16.	Service .....	Mahogany, compartment in lid.	1	1	0	
"	" .....	Mahogany no lid .....	15	0		
"	" .....	Ply wood, imitation leather covered.	10	6		Set only.
"	" .....	Old type cabinet, with lid and clasp.	1	1	0	Variometer tuned. Enclosed detector.
Sherman, P., 12, River Street, London, E.C.1	Clarecryst .....	Enclosed, leather covered.	1	0	0	Set only. With 1 pair headphones. Tuning either 5XX or local by switching twin detector illuminated.
"	de Luxe .....	Oak, American type, with doors.	2	5	0	" " " "
"	" .....	Mahogany, with lid .....	1	10	0	Set only. With 2 detectors. local or 5XX coil and 1 pair headphones.
Siemens Bros. & Co., Ltd., Woolwich, London, S.E.18.	Siemens .....	" .....	From 1	1	0	Set only.
Tant, W. H., & Co., Transant Works, Dollman Street, Birmingham.	Transant .....	Oak .....	6	6		Set only. Wavelength 150/550 metres.
Ward & Goldstone, Ltd., Pendleton, Manchester.	Goltone .....	Moulded, insulated top and base.	7	6		" " 150/1,800 "
"	" .....	" .....	15	0		"
"	" .....	" .....	1	5	0	"
Wilkins & Wright, Ltd., Kenyon Street, Birmingham.	Utility .....	Polished wood box .....	1	10	0	Set only.
Wootten, F. E., Ltd., 56, High Street, Oxford	Wootophone .....	Polished oak .....	1	12	0	Set only. With 5XX coil.
Yorkshire Radio Co., Western Works, Rockingham Street, Sheffield.	Deucalion .....	All types .....	From 6	6 to 2	0	Set only.



## CRYSTAL-VALVE SETS



Manufacturer.	Name of Set.	Type of Cabinet.	Valves.		Price.	Description and Remarks.
			H.F.	L.F.		
Baty, Ernest J., 157, Dunstable Road, Luton.	Baty Four .....	Polished mahogany, front controls, top lid on 22in. stand, with cupboard.	1	2	£ 36 0 0	Complete installation. Aerial and earth, cabinet and stand, H.T. and L.T. both off mains, 250/4,000 metres, 2 general and 2 power valves, A.R.10 loud-speaker, wired to 2 rooms, crystal or valve detector by switch.
British Thomson-Houston Co., Ltd., Crown House, Aldwych, London, W.C.2.	B.T.H. ....	Flat top, walnut case, sunken valves.	Reflex		3 2 6	Receiver only. With 3ft. twin flex and terminals and set of 2 loading coils for 5XX.
Edison Bell, Ltd., 62, Glangall Road, Peckham, London, S.E.15.	Edison Bell .....	Oak, desk .....	—	—	7 19 6	Receiver only. Reflex circuit incorporating H.F. amplification, crystal detection and L.F. amplification; also general purpose unit.
"	" .....	" .....	—	1	10 14 0	" " " "
"	" .....	Jacobean table grand.	—	1	14 5 0	" " " "
"	" .....	Jacobean, with twisted leg table.	—	1	17 0 0	" " " "
"	" .....	Mahogany table grand	—	1	16 2 6	" " " "
"	" .....	Mahogany de luxe, pedestal.	—	1	18 15 0	" " " "
"	" .....	Oak desk .....	—	2	13 2 6	" " " "
"	" .....	" .....	—	2	12 7 6	" " " "
Falk, Stadelmann & Co., Ltd., 83/93, Farringdon Road, London, E.C.1.	St. Vincent .....	Mahogany slab .....	2-valve Reflex.		6 10 0	Receiver only.
"	" .....	" .....	"	"	10 15 0	With H.T. battery, L.T. accumulator, aerial and earth equipment and 1 pair headphones.



# Buyer's Guide to Sets

CRYSTAL-VALVE SETS—continued.

Manufacturer.	Name of Set.	Type of Cabinet.	Valves.		Price.	Description and Remarks.
			H.F.	L.F.		
Falk, Stadelmann & Co., Ltd., 83/93 Farringdon Road, London, E.C.1.	St. Vincent	Mahogany slab	1-valve	Reflex.	£ 4 s. 7 d.	Receiver only.
			"	"	7 17 6	With H.T. battery, L.T. accumulator, aerial and earth equipment and 1 pair headphones.
Fallowfield, Jonathan, Ltd., 61/2, Newman Street, London, W.1.	Fallowflex	—	—	1	15 15 0	Receiver complete with valves, H.T. battery, L.T. accumulator, loud-speaker and aerial equipment.
Oxford Wireless Telephony Co., Ltd., 22, Queen Street, Oxford.	Oxford D.E.2 Valve Set	Polished mahogany, Radion panel.	2-valve	Reflex.	15 15 0	Complete with valves, batteries, coils up to 1,600 metres, loud-speaker and aerial supplies.
	Rawley Bros., Stamford Road, Handsworth, Birmingham.	Fireside	Oak	1	4 10 0	Complete with valve, batteries; receives local and Daventry stations.
S.H.C.S. Co., 10, Clare Terrace, Sidcup.	Thor No. 8	Dark oak	—	1	5 5 0	Complete with batteries inside cabinet and valve.
Siemens Bros. & Co., Ltd., Woolwich, London, S.E.18.	No. 9	—	—	2	10 10 0	As above, with loud-speaker.
	Siemens	Mahogany, with lid	—	1 or Det.	3 15 6	Receiver complete with D.E.3 valve, H.T. battery, L.T. accumulator, tuning coil (local or 5XX) and 1 pair headphones.
Ward & Goldstone, Ltd., Pendleton, Manchester.	Goltone	Oak	—	1	4 12 6	Receiver only.
	"	"	—	1	7 3 6	Complete with valve, H.T. battery, L.T. accumulator and headphones.



## SINGLE VALVE SETS



Manufacturer.	Name of Set.	Type of Cabinet.	Price.	Description and Remarks.
Alphian Wireless, Ltd., 99, Mortimer Street, London, W.4.	Alphian	Oak, mahogany or lacquer.	£ 10 0 0	Headphone use. Standard aerial. Receiver complete with valve and batteries. Chinese lacquer, £2 10s. extra.
British General Manufacturing Co., Ltd., Radio Works, Tyrwhitt Road, Brockley, London, S.E.4.	Britmax	Flat	2 17 6	Receiver only.
Dunham, C. S., 2a, Elm Park, Brixton Hill, London, S.W.2.	Dunham C.S.D.37	Flat	3 5 0	Receiver only.
Eagle Engineering Co., Ltd., Warwick.	Chakophone No. 1A	Hard wood, open box type.	3 12 6	Receiver only.
	" No. 11	Antique "salt box," with lid and phone compartment.	5 17 6	Complete with aerial supplies, valves, 60-volt H.T. battery, accumulator and 1 pair headphones.
	" No. 5A	Polished mahogany, with lid and battery compartment.	5 0 0	Complete with accessories as above. Receiver only.
Edison Bell, Ltd., 62, Glengall Road, Peckham, London, S.E.15.	Edison Bell	Oak, flat	8 5 0	Complete with accessories as above.
	"	Oak, with lifting and closing lid.	4 12 6	Receiver only. Double purpose unit incorporating reflex circuit, with H.F. transformer, 280/500 metres.
	"	Oak, flat	3 2 6	Receiver only. Detector with reaction coils, 280/500 metres.
Gamage, A. W., Ltd., Holborn, London, E.C.1.	Gamage	Mahogany	2 2 6	Receiver only. Transformer coupled note magnifier.
	"	"	4 4 0	Resistance coupled note magnifier.
Henderson, W. J., & Co., 351, Fulham Road, London, S.W.10.	B.R.I.	Oak, open	6 19 9	Receiver only.
	"	"	4 0 0	Complete with valve, H.T. battery, L.T. accumulator, headphones and aerial equipment.
Marconiphone Co., Ltd., 210/212 Tottenham Court Road, London, W.1.	Marconiphone V.1	Mahogany	Receiver only. With coils.	3 3 0
	"	"	5 4 6	Complete with valve, H.T. battery, L.T. accumulator and leads.
Oxford Wireless Telephony Co., Ltd., 22, Queen Street, Oxford.	Oxford 1-valve	Sloping desk, walnut	Receiver only.	2 14 6
	"	"	5 4 6	Complete with valve, H.T. battery, L.T. accumulator and leads.
Pye, W. G., & Co., Granta Works, Cambridge	No. 210	Polished mahogany	8 0 0	Complete with valve, batteries, coils to 1,600 metres and 1 pair headphones and aerial supplies.
	"	Walnut	3 12 6	Receiver only.
Radiax, Ltd., 16, Palmer Place, Holloway Road, London, N.7.	Radiax 60	Walnut	6 11 3	Complete with valves, batteries and 1 pair headphones.
	"	Open top	4 7 6	Receiver only.
Radio Supply Co., Superfone Works, Four Oaks, Birmingham.	Superfone Maxim I.	Mahogany, semi-portable.	4 17 6	Tuned plate. Daventry coil included.
	"	"	"	"
Regent Radio Supply Co., 45, Fleet Street, London, E.C.4.	Regentone	Mahogany, bided	5 10 0	Receiver only.
	"	"	"	"
Ward & Goldstone, Ltd., Pendleton, Manchester.	Goltone	Oak	3 2 6	Receiver only.
	"	"	5 13 6	Complete with valve, H.T. battery, L.T. accumulator and headphones.
Wilson, W. & Son (Herts) Ltd., 1, London Road, Royston.	Exceedall	Horizontal panel, with or without lid.	7 13 0	Complete with valve, batteries, 1 pair headphones, and aerial supplies, coils for 2L0 and 5XX.

# Buyer's Guide to Sets

## TWO VALVE SETS

Manufacturer.	Name of Set.	Type of Cabinet.	Valves.			Price.	Description and Remarks.
			H.F.	Det.	L.F.		
Alphian Wireless, Ltd., 99, Mortimer Street, London, W.1.	Alphian .....	Oak, mahogany or lacquer.	—	1	1	£ s. d. From 15 12 6	Complete with valves, H.T. battery and L.T. accumulator. Chinese lacquer, £2 10s. extra.
" " " " " " " " " " " " " "	" " " " " " " " " " " " " "	" " " " " " " " " " " " " "	—	—	2	30 0 0	Public address system. Self-contained, with microphone, valve and batteries.
Bannister & Fitton, 27, Milnrow Road, Rochdale.	B. & F. ....	Fall front, with hinged lid.	—	1	1	8 3 6	Receiver only.
" " " " " " " " " " " " " "	" " " " " " " " " " " " " "	12in. X 8in. panel ....	—	1	1	11 4 6	Complete with 2 D.E.R. valves, 66-voit H.T. battery, L.T. accumulator and coils.
Barnett & Soans, High Street, Kettering.	Barsoue.....	Lidded box.....	—	1	1	14 0 0	Complete with valves, H.T. battery, L.T. accumulator, headphones and loud-speaker.
Baty, Ernest J., 157, Dunstable Road, Luton.	Baty Two .....	Panel only.....	1	1	—	5 0 0	Receiver only. With coils, 250/4,000 metres.
Bowler-Lowe Co., Ltd., Letchworth, Herts.	Vox Populi Model III. 2-valve .....	Sloping front panel, lift-up lid, containing batteries and accumulator.	—	1	1	10 10 0	Receiver only.
" " " " " " " " " " " " " "	" " " " " " " " " " " " " "	" " " " " " " " " " " " " "	—	1	1	15 0 0	Complete with 2 D.E. valves, 1 large and 1 small accumulator, H.T. and G.B. batteries and Amplion A.R.38 loud-speaker.
British General Manufacturing Co., Ltd., Radio Works, Tyrwhitt Road, Brockley, London, S.E.4.	Britimax .....	Oak, table cabinet....	—	1	1	9 15 0	Receiver only.
" " " " " " " " " " " " " "	" " " " " " " " " " " " " "	Mahogany " " " " " " " " " " " " " "	—	1	1	11 15 0	" " " " " " " " " " " " " "
" " " " " " " " " " " " " "	" " " " " " " " " " " " " "	Oak, American type....	—	1	1	6 5 0	" " " " " " " " " " " " " "
" " " " " " " " " " " " " "	" " " " " " " " " " " " " "	Mahogany " " " " " " " " " " " " " "	—	1	1	6 10 0	" " " " " " " " " " " " " "
British Radio Corporation, Ltd., Weybridge.	B.R.C. 2-valve 200/2,000-metre.	Walnut or mahogany.	—	1	1	12 12 0	Complete with valves, H.T. and L.T. batteries and loud-speaker.
British Thomson-Houston Co., Ltd., Crown House, Aldwych, London, W.C.2.	B.T.H. ....	Flat top, walnut case, sunken valves.	—	1	1	6 5 0	Receiver only.
B.S.A. Radio, Ltd., Small Heath, Birmingham.	B.S.A. ....	Mahogany, with oxidised copper finish panel.	—	1	1	8 0 0	Receiver only.
" " " " " " " " " " " " " "	" " " " " " " " " " " " " "	" " " " " " " " " " " " " "	—	1	1	11 17 0	Complete with valves, H.T. battery, L.T. accumulator.
Burndept Wireless, Ltd., Eastnor House, Blackheath, London, S.E.3.	Ethophone Duplex ...	One-piece moulding, of insulating compound.	—	1	1	6 19 6	Receiver with H.L.565 valves and coils, 300/500 metres, and 5XX.
" " " " " " " " " " " " " "	" " " " " " " " " " " " " "	" " " " " " " " " " " " " "	—	1	1	7 11 6	" " " " " " " " " " " " " "
" " " " " " " " " " " " " "	" " " " " " " " " " " " " "	" " " " " " " " " " " " " "	—	1	1	8 0 6	" " " " " " " " " " " " " "
" " " " " " " " " " " " " "	" " " " " " " " " " " " " "	" " " " " " " " " " " " " "	—	1	1	12 9 6	" " " " " " " " " " " " " "
" " " " " " " " " " " " " "	Ethophone Two.....	Mahogany.....	—	1	1	12 9 6	Complete with valves, H.T. and L.T. batteries and loud-speaker.
" " " " " " " " " " " " " "	" " " " " " " " " " " " " "	" " " " " " " " " " " " " "	—	1	1	12 13 6	" " " " " " " " " " " " " "
" " " " " " " " " " " " " "	" " " " " " " " " " " " " "	" " " " " " " " " " " " " "	—	1	1	8 5 0 to	" " " " " " " " " " " " " "
" " " " " " " " " " " " " "	" " " " " " " " " " " " " "	" " " " " " " " " " " " " "	—	1	1	12 15 0	" " " " " " " " " " " " " "
Butterfields, Ltd., "Levis" Motor Works, Stechford, Birmingham.	Levis .....	Various .....	—	1	1	6 5 0	Receiver only.
C.A.C. Valve Distributing Co., Ltd., 10, Rangoon Street, Crutched Friars, London, E.C.3.	Duo-Valve .....	Mahogany or oak, American type.	—	1	1	10 2 3	Complete with valves, batteries, coils for 300/600 metres, and 1 pair headphones.
" " " " " " " " " " " " " "	" " " " " " " " " " " " " "	" " " " " " " " " " " " " "	—	1	1	8 8 0	Receiver only.
Cantophone Wireless Co., 310, Regent Street, London, W.1.	Cantophone .....	Polished mahogany... ..	—	1	1	14 14 0	Complete with H.T. battery, L.T. accumulator, loud-speaker, valves and tuner. Tuning dial calibrated direct in wave-lengths.
" " " " " " " " " " " " " "	" " " " " " " " " " " " " "	" " " " " " " " " " " " " "	—	1	1	8 8 0	Receiver only.
Cleartron Radio, Ltd., 1, Charing Cross, London, S.W.1.	Lodge N. Circuit ....	Honduras mahogany, sloping front.	—	1	1	15 15 0	Complete with valves, H.T. battery, L.T. accumulator and loud-speaker.
Day, Will, Ltd., 19, Lisle Street, Leicester Square, London, W.C.2.	Regent .....	American type, upright panel.	—	1	1	4 17 6	Receiver only.
Dunham, C. S., 2a, Elm Park, Brixton Hill, London, S.W.2.	Dunham C.S.D.58 ...	Flat type.....	—	1	1	5 17 6	Receiver only.
" " " " " " " " " " " " " "	" " C.S.D.63 ...	Oak cabinet.....	—	1	1	7 5 0	" " " " " " " " " " " " " "
" " " " " " " " " " " " " "	" " C.S.D.42 ...	Mahogany, desk type.	—	1	1	8 15 0	" " " " " " " " " " " " " "
" " " " " " " " " " " " " "	" " C.S.D.48 ...	Cabinet model.....	1	1	—	11 18 6	Complete with valves and battery.
" " " " " " " " " " " " " "	" " C.S.D.48D ...	Double-fronted doors.	1	1	—	13 3 6	" " " " " " " " " " " " " "
Eagle Engineering Co., Ltd., Warwick.	Chakophone No. 9 ...	Oak, vertical panel with compartment for H.T. battery.	—	1	1	6 15 0	Receiver only.
" " " " " " " " " " " " " "	" " " " " " " " " " " " " "	" " " " " " " " " " " " " "	—	1	1	11 7 0	Complete with aerial supplies, valves, batteries and loud-speaker.
" " " " " " " " " " " " " "	" " Super No. 9	Mahogany (as above).	—	1	1	8 15 0	Receiver only.
" " " " " " " " " " " " " "	" " " " " " " " " " " " " "	" " " " " " " " " " " " " "	—	1	1	13 7 0	Complete with accessories as above.
" " " " " " " " " " " " " "	" " No. 2 ...	Mahogany, sloping panel.	1	1	—	6 17 6	Receiver and coils only.
Edison Bell, Ltd., 62, Glengall Road, London, S.E.15.	Gem.....	Oak, flat type .....	—	1	1	4 5 0	Receiver only. With coils, 280/500 metres. Moulded panel with black ebonium terminals. Detector with reaction, 1-stage low-frequency amplification. Fitted with rheostat and grid bias battery.
" " " " " " " " " " " " " "	" " " " " " " " " " " " " "	" " " " " " " " " " " " " "	—	1	1	5 0 0	" " " " " " " " " " " " " "
" " " " " " " " " " " " " "	Bijou .....	Oak, with closing transparent oval front.	—	1	1	5 0 0	" " " " " " " " " " " " " "
" " " " " " " " " " " " " "	Prince .....	Oak, fitted with closing doors and lifting lid.	—	1	1	5 15 0	" " " " " " " " " " " " " "

# Buyer's Guide to Sets

VALVE SETS (2 Valves)—continued.

Manufacturer.	Name of Set.	Type of Cabinet.	Valves.			Price.	Description and Remarks.
			H.F.	Det.	L.F.		
Edison Swan Electric Co., Ltd., 123/5, Queen Victoria Street, London, E.C.4.	Ediswan Compactum.	Moulded Bakelite ....	—	1	1	£ s. d. 4 0 0	Receiver only.
	" "	" " ....	—	1	1	10 19 8	Complete with 60-volt H.T. battery, filament dry battery, D.E.202, 2 tuning coils, L.40 and L.50 Igranic, 100ft. 7/22 aerial wire, 9in. lead-in tube, earth clip, 4 porcelain insulators, battery leads, 3 yds. thick rubber cable, 6 yds. connecting wire, 1 Dukivox loud-speaker, 2 P.V.8 D.E. power valves.
	" "	" " ....	—	1	1	11 8 2	As above, but with N.W.23 accumulator, 6 v. 30 a.h. actual in place of D.E.202 filament battery and P.V.5 D.E. valves in place of the 2 P.V.8 D.E. valves.
" "	Ediswan Hoover Radiophone	Upright, walnut, vertical panel with controls, enclosed valves.	—	1	—	11 5 0	Receiver with H.T. and grid batteries and 1 pair range blocks.
" "	" "	" " ....	—	1	—	14 16 8	Complete with H.T. and grid batteries, 1 pair range blocks, 1 pair headphones, 100ft. 7/22 S.W.G. aerial wire, 2 pairs porcelain insulators, 9in. lead-in tube, 3 yds. 19/24 S.W.G. earth wire or lead-in rubber covered, 1 earth clip, 1 4 v. 30 a.h. (actual) accumulator and 2 A.K. valves.
Eriasson Telephones, Ltd., 67/73, Kingsway, London, W.C.1.	0/1201 .....	Box type, flat top ....	1	1	—	6 5 0	Receiver only.
" "	0/1082 Family Set ....	Oak cabinet, folding doors.	—	1	1	8 15 0	"
Express Radio Co., Ltd., 66, High Holborn, London W.C.1.	Express No. 258 .....	Oak or mahogany, American type.	—	1	1	8 10 0	Receiver only.
Falk, Stadelmann & Co., Ltd., 83/85, Farringdon Road, London, E.C.1.	Seymour .....	Oak, sloping, with sliding shutter.	—	1	1	11 15 0	Receiver only.
" "	" "	" " ....	—	1	1	15 2 6	Complete with H.T. and G.B. batteries, L.T. accumulator, aerial and earth equipment and 1 pair headphones.
" "	Gordon .....	Mahogany, upright ..	—	1	1	12 10 0	Receiver only.
Felcourt Products, Ltd., East Grin- stead.	Felcourt 2-valve, Press- button Dual Pro- gramme.	Polished mahogany ...	—	1	1	8 0 0	Receiver only.
" "	" "	" " ....	—	1	1	7 17 6	Receiver only.
Flinders (Wholesale), Ltd., 121, High Street, Colchester.	Flinderphone Super- Two.	American type, oak or mahogany.	—	1	1	6 10 0	Receiver only. Self-contained A.T.T. tapped, 250/2,000 metres, reaction over whole range.
Gamage, A. W., Ltd., Holborn, London, E.C.1.	Gamage Super II. ...	American type .....	—	1	1	7 0 0	Receiver only.
" "	" " ....	" " ....	—	1	1	12 0 0	Complete with valves, H.T. and G.B. batteries, L.T. accumulator, 1 pair phones and aerial equipment.
Gambrell Bros., Ltd., 76, Victoria Street, London, S.W.1.	Gambrell Baby Two .	Mahogany, coils and valves enclosed; all connections to terminal board at the back.	—	1	1	8 0 0	Receiver only. With coils, 300/300 metres.
" "	Gambrell Cabinet Two	Polished mahogany, valves, coils and batteries totally enclosed.	—	1	1	10 15 0	" " " "
" "	Gambrell Baby Grand, D.C. Mains Model.	Polished mahogany, all enclosed.	—	1	1	17 0 0	Receiver, complete with valves and coils for local station and 5XN.
" "	Gambrell Baby Grand, A.C. Mains Model.	" " ....	—	1	1	22 17 6	" " " "
General Electric Co., Ltd., Magnet House, Kingsway, London, W.C.2.	Geophone 2-valve No. B.C.2720.	Mahogany, hinged lid, open desk type, mahoganite panel.	—	1	1	9 15 0	Receiver with valves only.
" "	Geophone 2-valve, B.C.2721.	Mahogany, hinged lid, open desk type, mahoganite panel.	—	1	1	13 19 3	Complete with valves, batteries, loud-speaker and connecting cords and plugs.
" "	Cabinet model B.C.3220	Mahogany, with doors and compartment for battery.	—	1	1	11 12 0	Receiver with valves only.
" "	" " B.C.3200	" " ....	—	1	1	14 2 6	Complete with valves, batteries, connecting cords and plugs.
General Radio Co., Ltd., 255, Regent Street, London, W.1.	G.R.C.15 .....	Walnut .....	—	1	1	12 0 0	Complete with valves, batteries, 1 pair headphones and loud-speaker.
Gillan Bros., Ltd., 68/64, High Holborn, London, W.C.1.	Gillan II. ....	Oak or mahogany, vertical panel, valves and coils enclosed, lift-up lid, terminals at back.	—	1	1	7 5 0	Receiver only.
" "	" " ....	" " ....	—	1	1	13 1 6	Complete with valves, H.T. battery, L.T. accumulator, battery leads, aerial and earth equipment, 1 pair headphones and coils for 300/700 metres.
" "	Gillan II. N.D.C. Model	" " ....	—	1	1	13 17 0	Receiver only.
" "	" " ....	" " ....	—	1	1	15 19 0	Complete with valves, aerial and earth equipment and coils for 300/700 metres.

# Buyer's Guide to Sets

VALVE SETS (2 Valves)—continued.

Manufacturer.	Name of Set.	Type of Cabinet.	Valves.			Price.	Description and Remarks.
			H.F.	Det.	L.F.		
Henderson, W. J., & Co., Ltd., 351, Fulham Road, London, S.W.10.	H.R.2	Oak or mahogany, all enclosed.	1	1	—	£ s. d. 9 5 0	Receiver only with coils.
" " "	"	"	1	1	—	13 3 6	Complete with valves, H.T. battery, L.T. accumulator, 1 pair headphones and aerial equipment and leads.
" " "	B.R.2	Oak, open	—	1	1	6 5 0	Receiver only, with coils.
" " "	C.R.2	Mahogany, all enclosed	—	1	1	7 10 0	"
Johnson, T. J., 17 and 19, Catherine Street, Salisbury.	Sarumphone 2-valve	Mahogany, 2-door	1	1	—	10 10 0	Complete with valves, batteries and coils, 250/500 and Daventry.
Lamplugh, Ltd., S. A., King's Road, Tyseley, Birmingham.	Quality 2-valve	Oak, mahogany or walnut, batteries enclosed.	—	1	1	15 13 0	Complete with valves, batteries and loud-speaker.
" " "	Popular 2-valve	Mahogany, flat, open type.	—	1	1	6 12 6	Receiver only.
M.A.P. Co., 216, Gt. Lister Street, Birmingham.	M.A.P. Minor	Mahogany, vertical panel.	—	1	1	8 15 0	Receiver only.
" " "	Popular	Open, polished aluminium.	—	1	1	11 11 6	Complete with all accessories.
" " "	"	"	—	1	1	7 2 6	Receiver only.
" " "	"	"	—	1	1	10 19 0	Complete with valves, batteries and accessories.
Marconiphone Co., Ltd., 210/212, Tottenham Court Road, London, W.1.	Marconiphone V.2	Teak	1	1	—	5 5 0	Receiver only. 1 valve reflexed.
" " "	"	"	1	1	—	8 0 0	Complete with valves, H.T. battery, L.T. accumulator and leads.
" " "	Marconiphone Type 21	Mahogany	—	1	1	8 15 0	Receiver only.
" " "	"	"	—	1	1	13 2 6	Complete with valves, H.T. and G.B. batteries, L.T. accumulator and leads.
Midland Radiotelephone Co., Ltd., Brettell Lane Works, Stourbridge.	Mellowtone	Box	—	1	1	8 15 0	Receiver only.
Premier Manufacturing Co., 114/115, Gt. Safron Hill, London, E.C.	Mono-sone	Mahogany	—	1	1	24 10 0	Complete with valves and batteries.
Pye, W. G., & Co., Granta Works, Cambridge.	No. 220	Walnut	—	1	1	5 9 0	Receiver only.
" " "	"	"	—	1	1	19 19 3	Complete with valves, batteries, coils up to Daventry and loud-speaker.
" " "	No. 720	"	—	1	1	8 15 0	Receiver only.
" " "	"	"	—	1	1	14 5 3	Complete with valves, batteries and loud-speaker.
" " "	No. 720D.	" with door	—	1	1	9 15 0	Receiver only.
" " "	"	"	—	1	1	15 5 3	Complete with valves, batteries and loud-speaker.
Radiax, Ltd., 16, Palmer Place, Holloway Road, London, N.7.	Radiax 61	Open top	—	1	1	6 0 0	Receiver only.
" " "	" 61	"	—	1	1	11 10 0	Complete with valves, batteries, headphones, loud-speaker and aerial supplies.
" " "	" 34	Mahogany, with lid	1	1	—	6 12 6	Receiver only.
" " "	" 34	"	1	1	—	10 7 6	Complete with valves, batteries, headphones and aerial supplies.
Radio Communication Co., Ltd., High Street, Barnes, London, S.W.	Polar Twin	"	—	1	1	5 5 0	Receiver only.
" " "	"	"	—	1	1	10 10 0	Complete with valves, batteries, 300/500 and 1,400/1,700, aerial reaction unit and loud-speaker.
" " "	"	Oak, vertical type, 2 doors.	—	1	1	11 11 0	Complete, as above.
Radio Instruments, Ltd., 12, Hyde Street, London, W.C.1.	R.I.	Polished mahogany	—	1	1	11 0 0	Receiver only.
Radio Supply Co., Superfone Works, Four Oaks, Birmingham.	Superfone Maxum II.	Mahogany, semi-portable.	—	1	1	7 7 0	Receiver only. Tuned plate. Daventry coil embodied.
" " "	Easitone II.	Mahogany, flat table model.	—	1	1	4 5 0	Receiver only. Single-dial control.
Regent Radio Supply Co. 45, Fleet Street, London, E.C.4.	Regentone	Mahogany, all enclosed lidded	—	1	1	9 9 0	Receiver only.
Rotax (Motor Accessories), Ltd., Willesden Junction, N.W.10.	Rotola II.	Upright, with folding doors.	—	1	2	7 10 0	"
R.M. Radio, Ltd., 19, Garrick St., London, W.C.2.	RZ	Oak or mahogany	—	1	1	13 0 0	Complete with valves, batteries, coils and loud-speaker.
" " "	"	"	—	1	1	26 0 0	Receiver only.
Service Radio Co., Ltd., 62, Church Street, Stoke Newington, N.16.	Service 2-valve	Oak, American type	—	1	1	3 15 0	Complete with valves, batteries and "Kone" loud-speaker.
" " "	" de Luxe	"	—	1	1	8 0 0	Receiver only. 1-knob control.
Sherman, P., 12, River Street, London, E.C.1.	Claremont 2	Oak, with doors, American type	—	1	1	9 9 0	Receiver only.
Stevens, A. J., & Co. (1914), Ltd., Wolverhampton.	Symphony Two	Mahogany, table model, with compartment for batteries.	—	1	1	17 10 0	Complete with valves, H.T. battery, L.T. accumulator, aerial equipment and loud-speaker.
Ward & Goldstone, Ltd., Pendleton, Manchester.	Type Z.T.	Mahogany	—	1	1	13 18 6	Receiver only.
" " "	Goltouc A	Oak	—	1	1	5 17 6	"
" " "	"	"	—	1	1	7 17 6	Complete with valves, H.T. battery, L.T. accumulator and headphones.
" " "	" B	"	—	1	1	11 0 0	Receiver only.
" " "	"	"	—	1	1	7 17 6	"
" " "	" S	Mahogany	—	1	1	8 0 0	"
" " "	"	"	—	1	1	11 16 6	Complete with valves, H.T. battery, L.T. accumulator and headphones.
Wootten, F. E., Ltd. 56, High Street, Oxford.	Wootophone D.3	Polished oak	—	1	1	8 10 0	Receiver only.
" " "	"	"	—	1	1	13 0 0	Complete with valves, H.T. and G.B. batteries, L.T. accumulator, aerial equipment and loud-speaker.
Yorkshire Radio Co., Western Works, Rockingham Street, Sheffield	Deucalion	All types	—	1	1	8 8 0	Receiver only.

# Buyer's Guide to Sets



Manufacturer	Name of Set.	Type of Cabinet.	Valves.			Price.	Description and Remarks.
			H.F.	Det.	L.F.		
Alphian Wireless, Ltd., 99, Mortimer Street, London W.1.	Alphian	Oak, mahogany or lacquer.	—	1	2	£ s. d. 26 17 6	Complete with valves, H.T. battery and L.T. accumulator. Chinese lacquer, £ 10s. extra.
" " " "	"	"	—	—	3	80 0 0	Public address system. Two loud-speakers, 20-guinea microphone, valves and batteries.
Bannister & Fitton, 27, Milrow Road, Rochdale.	B. & F.	Fall front with hinged lid, 16in. by 8in. panel.	—	1	2	15 3 0	Receiver only.
" " " "	"	"	—	1	2	19 10 6	Complete with 2 D.E.R., 1 D.E.6 valves, 80 volt, H.T. battery, accumulator and coils.
Barnett & Soans, High Street, Kettering.	Barsons.	Mahogany moulded	—	1	2	19 0 0	Complete with valves, H.T. battery, L.T. accumulator, headphones and loud-speaker.
Beard & Fitch, Ltd., 34, Aylesbury Street, London, E.C.1.	Success Super III.	American type, oxy-dised silver fittings.	—	1	2	17 10 0	Complete with valves, batteries and "Mellorox" loud-speaker, tunable from 40/2,500 metres.
Boywer, Lowe Co., Ltd., Letchworth, Herts.	Vox Populi, Model III. 3-valve.	Sloping front panel, lift-up lid, containing batteries and accumulator.	—	1	3	13 10 0	Receiver only.
" " " "	"	"	—	1	2	19 0 0	Complete with 3 D.E. valves, 1 large and 1 small accumulator, H.T. and G.B. batteries and Amphion A.R.38 loud-speaker.
British & Colonial Industries Association, Ltd., 329, High Holborn, London, W.C.1.	B.C.I., Mark III.	Polished oak	1	1	1	19 10 0	Complete with frame aerial, dry batteries, valves and phones.
British General Manufacturing Co., Ltd., Radio Works, Tyrwhitt Road, Brockley, London, S.E.1.	Britimax de Luxe	Oak pedestal	—	1	2	21 17 6	Receiver only.
" " " "	"	Mahogany pedestal	—	1	2	26 17 6	"
" " " "	Britimax	Oak table	—	1	2	12 7 6	"
" " " "	"	Mahogany table	—	1	2	15 10 6	"
" " " "	"	Oak, American type	—	1	2	7 17 6	"
" " " "	"	Mahogany, American type.	—	1	2	8 7 6	"
British Radio Corporation, Ltd., Weybridge.	B.R.C. 3-valve, 200/2000 metres.	Mahogany or walnut	—	1	2	17 17 0	Complete with valves, H.T. and L.T. batteries and loud-speaker.
British Thomson-Houston Co., Ltd., Crown House, Aldwych, London, W.C.2.	B.T.H.	Self-contained with L.S.	with dual amplification.			36 17 6	Complete with H.T. battery, L.T. accumulator, aerial and earth plug connectors, 1 pair headphones and set of 5XX loading coils.
B.S.A. Radio, Ltd., Small Heath, Birmingham.	B.S.A.	Mahogany with oxy-dised copper finish panel.	—	1	2	15 7 6	Receiver only.
" " " "	"	"	—	1	2	21 17 6	Complete with valves, H.T. battery and L.T. accumulator.
Burndep Wireless, Ltd., Eastnor House, Blackheath, London, S.E.5.	Ethophone Triplex	Two-piece moulding of insulating compound on mahogany plinth.	—	1	2	10 14 6	Complete with 211.L. 565 and 1 L240 valves, coils 300/500 metres and 5XX.
" " " "	"	"	—	1	2	11 6 6	Complete with 2 H.L. 213 and 1 L240 valves, coils 300/500 metres and 5XX.
" " " "	"	"	—	1	2	11 15 6	Complete with 2 H.L. 512 and 1 L240 valves, coils 300/500 metres and 5XX.
" " " "	Ethophone Three	Mahogany	—	1	2	13 17 6	Complete with 2 H.L. 512 and 1 L1.525 valves, coils 200/650 metres and 5XX unit, 1 telephone plug
Butterfields, Ltd., Levis Motor Works, Stechford, Birmingham.	Levis	"	1	1	1	14 17 6	Receiver only.
C.A.C. Valve Distributing Co., Ltd., 10, Rangoon Street, Crutched Friars, London, E.C.3.	Popular III.	Mahogany or fumed oak, American type.	—	1	2	10 7 6	Receiver only.
" " " "	"	"	—	1	2	18 3 3	Complete with valves, batteries, coils, 300/600 metres, and "Bullphone" loud-speaker.
" " " "	Super III.	"	1	1	1	10 7 6	Receiver only.
" " " "	"	"	1	1	1	17 2 0	Complete with valves, batteries, coils, 300/600 metres and "Bullphone" loud-speaker.
Day, Will, Ltd., 19, Lisle Street, Leicester Square, W.C.2.	Connaught	American type	—	1	2	8 10 0	Receiver only.
Dunham, C. S., 2a, Elm Park, Brixton Hill, London, S.W.2.	Dunham C.S.D.45	Mahogany sloping desk	1	1	1	12 3 0	Receiver only.
" " " "	"	"	1	1	1	17 5 0	Complete with valves, batteries and 1 pair headphones.
" " " "	C.S.D.51	Cabinet type	1	1	1	13 18 6	Receiver only.
Dynamergy Mains Supply, Staines.	Dymo III.	Mahogany	—	1	2	20 15 0	Valves not included.
" " " "	"	"	1	1	1	20 5 0	L.T. and H.T. from D.C. Mains.
Eagle Engineering Co., Ltd., Warwick	Chakophone No. 1B	Oak, with folding doors and compartment in base.	—	1	2	11 17 6	Receiver only.
" " " "	"	"	—	1	2	18 16 0	Complete with aerial supplies, valves, batteries and loud-speaker.
" " " "	Chakophone No. 1C	Mahogany open panel, compartment in base	—	1	2	11 17 6	Receiver only.
" " " "	"	"	—	1	2	18 16 0	Complete with accessories as above.
" " " "	Chakophone No. 7	Mahogany (as above)	1	1	1	14 14 9	Receiver and coils only.
" " " "	"	"	1	1	1	22 16 9	Complete with accessories as above.



# Buyer's Guide to Sets

VALVE SETS (3 Valves)—continued.

Manufacturer.	Name of Set.	Type of Cabinet.	Valves.			Price.	Description and Remarks.
			H.F.	Det.	L.F.		
Edison Bell, Ltd., 62, Glengall Road, Peckham, London, S.E.15.	King .....	Oak fitted with closing door and lifting lid.	—	1	2	£ s. d. 8 5 0	Receiver with coils, 280/500 metres. Detector with reaction and 2 stages. Transformer coupled low frequency amplification.
Ericsson Telephones, Ltd., 67/73, Kingsway, London, W.C.2.	0/1083 Enclosed Three	Mahogany cabinet, folding doors.	1	1	1	30 0 0	Receiver only.
Express Radio Co., Ltd., 66, High Holborn, London, W.C.1.	Express No. 365 .....	Oak, vertical panel ..	—	1	2	15 0 0	Receiver only. First L.F. valve transformer coupled; second valve choke-coupled. Can be used as 1-, 2- or 3-valve set.
Falk, Stadelmann & Co., Ltd., 83/93, Farringdon Road, London, E.C.1.	Rodney .....	Walnut sloping .....	1	1	1	14 7 6	Receiver only.
"	" .....	" .....	1	1	1	18 17 6	Complete with H.T. and G.B. batteries, L.T. accumulator, aerial and earth equipments and 1 pair headphones.
"	Hood .....	Walnut slab .....	1	1	1	17 7 6	Receiver only.
"	" .....	" .....	1	1	1	12 17 6	"
"	Nelson .....	Sloping mahogany with roll front.	1	1	1	22 17 6	"
"	" .....	" .....	1	1	1	27 2 6	Complete with H.T. and G.B. batteries, L.T. accumulator, aerial and earth equipments and 1 pair headphones.
"	Clive .....	Upright mahogany or oak.	1	1	1	20 15 0	"
"	" .....	" .....	1	1	1	15 7 6	Receiver only.
Felcourt Products, Ltd., East Grinstead.	Felcourt de Luxe Press-button Dual Programme.	Polished mahogany ..	—	1	2	16 16 0	Receiver only.
"	" .....	" .....	—	1	2	21 0 0	Complete with valves, batteries and loud-speaker.
Flinders (Wholesale), Ltd., 121, High Street, Colchester.	Flinderphone Super Three.	—	—	1	2	8 7 6	Receiver only. Self-contained A.T.1 tapped 250/2,000 metres, reaction over whole range.
Gamage, A. W., Ltd., Holborn, London, E.C.1.	Gamage Super III ..	American type .....	—	1	2	10 12 6	Receiver only.
"	" .....	" .....	—	1	2	16 16 0	Complete with valves, H.T. and G.B. batteries, L.T. accumulator, aerial equipments and 1 pair headphones.
Gambrell Bros., Ltd., 76, Victoria Street, London, S.W.1.	Gambrell Cabinet Three	Polished mahogany, drop down flap covers operating panel. Lower part with 2 doors for batteries and accumulator.	1	1	1	18 17 6	Receiver with coils for local and 3XX. Embodies master switch—all controls slow motion.
"	Gambrell Cabinet Three D.C. Mains Model.	" .....	1	1	1	25 7 6	Complete with valves and coils for local and 3XX. All controls slow motion.
"	A.C. Mains Model.	" .....	1	1	1	33 0 0	"
General Electric Co., Ltd., Magnet House, Kingsway, London, W.C.2.	Gecophone 3-valve B.C.2720.	Mahogany open front, hinged lid.	—	1	2	26 2 6	Set with 3 D.T.5 Osram valves only (230/3,000 metres).
"	B.C.2731	" .....	—	1	2	26 10 0	Complete with 3 valves, batteries, connecting cords and plugs.
"	B.C.2833	Mahogany with oxidised bronze centre plate.	—	1	2	18 17 6	With 3 D.T.5 Osram valves only.
"	" .....	" .....	—	1	2	25 5 0	As above but with batteries, connecting cords and plugs.
General Radio Co., Ltd., 255, Regent Street, London, W.1.	G.R.C.17 .....	Walnut .....	—	1	2	15 0 0	Complete with valves, batteries, 1 pair headphones and loud-speaker.
Gent & Co., Ltd., Faraday Works, Leicester.	Rachomatic B .....	Small, not self-contained.	1	1	1	17 7 6	Receiver with valves and coils.
Gillilan Bros., Ltd., 63/64, High Holborn, London, W.C.1.	Gillilan III .....	Oak or mahogany vertical panel, valves and coils enclosed; lift-up lid terminals at back.	—	1	2	12 7 6	Receiver only.
"	" .....	" .....	—	1	2	18 8 0	Complete with valves, H.T. battery, L.T. accumulator, battery leads, aerial and earth equipments, coils for 300/700 metres and 1 pair headphones.
"	Gillilan IIIa .....	" .....	1	1	1	17 18 6	Receiver only.
"	" .....	" .....	1	1	1	11 17 6	"
"	Monodyne III .....	Oak or mahogany with battery compartment and doors.	—	1	2	21 17 6	Receiver only.
"	" .....	" .....	—	1	2	27 6 9	Complete with valves, H.T. battery, L.T. accumulator and 1 pair headphones. No aerial or earth are required but provision is made for an external aerial and earth if desired. Wavelength range 200/600 metres.
"	Gillilan L.G. III .....	" .....	—	1	2	14 9 6	Receiver only. One knob control. Complete with valves, H.T. battery, L.T. accumulator, battery leads, aerial and earth equipments, coils for 300/700 metres and 1 pair headphones.
"	" .....	" .....	—	1	2	27 6 9	Receiver only with coils.
Henderson, W. J., & Co., Ltd., 351, Fulham Road, London, S.W.10.	H.R.3 .....	Mahogany or oak, all enclosed.	1	1	1	13 17 6	Complete with valves, H.T. battery, L.T. accumulator, aerial equipment and leads and 1 pair headphones.
"	" .....	" .....	1	1	1	19 3 6	"

# Buyer's Guide to Sets

## VALVE SETS (3 Valves)—continued.

Manufacturer.	Name of Set.	Type of Cabinet.	Valves.			Price.	Description and Remarks.
			H.F.	Det.	L.F.		
Henderson, W. J. & Co., Ltd., 351 Fulham Road, London, S.W.10	C.R.3	Mahogany, all enclosed	—	1	2	£ 11 7 0	Receiver with coils.
"	R.3	"	—	1	2	13 17 6	"
"	B.R.3	"	—	1	2	8 10 0	"
Johnson, T. J., 17 and 19, Catherine Street, Salisbury.	Sarumphone 3-valve.	Oak, open	—	1	2	15 0 0	Complete with valves, batteries and coils (250/500 and Daventry). Receiver only.
Lampugh, S. A., Ltd., King's Road, Tyseley, Birmingham.	3-valve	Mahogany, 2-door	1	1	1	18 7 6	Complete with valves, batteries and coils (250/500 and Daventry). Receiver only.
Marconiphone Co., Ltd., 210/212, Tottenham Court Road, London, W.1.	Marconiphone 31	Oak, with pedestal comprising batteries.	—	1	2	14 9 6	Receiver only.
"	"	Mahogany	—	1	2	20 6 0	Complete with valves, H.T. and G.B. batteries. L.T. accumulator and leads.
"	Marconiphone V.3A	"	1	1	1	32 15 6	Receiver only, 1 valve reflexed.
"	"	"	1	1	1	27 6 0	Receiver only.
"	Sterling Anodian	Walnut sloping desk	—	1	2	10 5 6	Complete with valves, H.T. battery, L.T. accumulator and leads.
"	"	"	—	1	2	17 2 8	"
"	Sterling 3-valve table Cabinet.	Walnut	—	1	2	23 17 2	"
Metro-Vick Supplies, Ltd., 155, Charing Cross Rd., London, W.C.2	Cosmos	Circular moulded base	—	1	2	16 11 6	Receiver only.
"	"	"	—	1	2	8 5 0	Receiver with coil unit 250/550 metres and 6ft. flexible lead for batteries.
"	"	"	—	1	2	14 14 9	Complete with valves, H.T. batteries, L.T. accumulator, aerial and earth equipment and loud-speaker.
Midland Radiotelephone Co., Ltd., Brettell Lane Works, Stourbridge.	Mellowtone	Box	—	1	2	16 17 6	Receiver only with coils.
"	"	Popular	—	1	2	20 17 6	"
"	"	Oak de Luxe	—	1	2	26 17 6	"
"	"	Model de Luxe	—	1	2	31 17 6	"
Oxford Wireless Telegraphy Co., Ltd., 22, Queen Street, Oxford.	Oxford 3-valve D.E. Set.	Polished mahogany, Radion panel, nickel fittings.	1	or 1	2	18 0 0	Complete with valves, batteries, coils up to 1,600 metres, headphones and aerial supplies.
"	"	Do. with compartment for batteries.	1	or 1	2	21 10 0	"
Primus Manufacturing Co., 114/115, Great Saffron Hill, London, E.C.1.	Q Loud-speaker Set.	Mahogany	2	1	—	6 6 0	Receiver only.
"	"	"	2	1	—	12 12 0	Complete with valves, batteries and loud-speaker.
Pye, W. G., & Co., Granta Works, Cambridge.	No. 730	Walnut	1	1	1	14 7 6	Receiver only.
"	"	"	1	1	1	26 1 0	Complete with valves, batteries and loud-speaker.
"	No. 730D	With door	1	1	1	15 7 6	Receiver only.
"	"	"	1	1	1	27 1 0	Complete with valves, batteries and loud-speaker.
"	No. 830D	"	—	1	2	16 7 6	Receiver only.
"	"	"	—	1	2	28 8 5	Complete with valves, batteries and loud-speaker.
"	No. 830	"	—	1	2	14 7 6	Receiver only.
"	"	"	—	1	2	25 8 5	Complete with valves, batteries and loud-speaker.
Radio-Arc Electrical Co., Ltd., Bennett Street, Chiswick, London, W.1.	All Wave	Oak	Three valves.			17 12 6	Receiver only.
Radiax, Ltd., 16, Palmer Place, Holloway Road, London, N.7.	Challenge 46	Oak, with folding doors, upright panel.	1	1	1	12 2 6	Receiver only.
"	"	"	1	1	1	16 16 6	Complete with valves, batteries, headphones and aerial supplies.
"	Radiax 36	Mahogany, with lid	1	1	1	10 0 0	Receiver only.
"	"	"	1	1	1	14 12 6	Complete with valves, batteries, headphones and aerial supplies.
Radio Communication Co., Ltd., High Street, Barnes, London, S.W.	Radiax 62	"	—	1	2	10 7 6	Receiver only.
"	Polar Three	Mahogany, vertical panel, lid on top.	—	1	2	11 17 6	Receiver only.
"	"	"	—	1	2	16 7 9	Complete with valves, batteries, aerial-reaction coils.
Radio Instruments, Ltd., 13, Hyde Street, London, W.C.1.	R1	"	—	1	2	19 12 9	Complete as above with loud-speaker.
Radio Supply Co., Superfone Works, Four Oaks, Birmingham.	Superfone Maxum III.	Mahogany, upright table model.	—	1	2	16 17 6	Receiver only.
"	Easitone III.	Mahogany, flat table model.	—	1	2	7 12 6	Receiver only. Single-dial control.
Regent Radio Supply Co., 45, Fleet Street, London, E.C.1.	Regentone	Mahogany, all enclosed	—	1	2	12 12 0	Receiver only.
R.M. Radio, Ltd., 19, Garrick Street, London, W.C.2.	RZ	Oak or mahogany	—	1	2	17 15 0	Receiver only.
"	"	"	—	1	2	32 10 0	Complete with valves, batteries and "Kone" loud-speaker.
"	Carpenter	"	1	1	1	32 10 0	Receiver only.
"	"	"	1	1	1	47 10 0	Complete with valves, batteries and "Kone" loud-speaker.
Rotax (Motor Accessories), Ltd., Willesden Junction, N.W.10.	Rotola III.	Upright, with folding doors.	—	1	2	28 2 6	Complete with valves, batteries, coils and loud-speaker.
"	" de Luxe	Self-contained, with space for batteries and built-in loud-speaker.	—	1	2	33 7 6	Complete, as above.
"S. A. Cutters," Ltd., 18, Berners Street, London, W.1.	Baby Grand Simplicit Three.	American, without lid, space for batteries.	—	1	2	26 17 6	With valves and batteries.
"	"	"	—	1	2	18 5 0	Complete with valves, batteries and leads. Loud-speaker plug controls current to valves.

# Buyer's Guide to Sets

VALVE SETS (3 Valves)—continued.

Manufacturer.	Name of Set.	Type of Cabinet.	Valves.			Price.	Description and Remarks.
			H.F.	Det.	L.F.		
"S. A. Cutters," Ltd., 18, Berners Street, London, W.1. Service Radio Co., Ltd., 62, Church Street, Stoke Newington, N.16. Sherman, P., 12, River Street, London, E.C.1.	Salient Simplicity Three de Luxe	American, without lid, space for batteries.	—	1	2	£ s. d. 19 7 6	As previous, but choke-coupling instead of transformer.
	Service 3-valve	Oak or mahogany	1	1	1	5 12 6	Receiver only. 1-knob control.
	Claremont " de Luxe	" (American type) Oak, American type, with doors.	1	1	1	10 2 6	Complete with valves, H.T. battery, L.T. accumulator, enclosed with separate loud-speaker. 1-dial control.
Siemens Bros. & Co., Ltd., Woolwich, London, S.E.18.	Siemens S.B.39	Mahogany	1	1	1	17 17 6	Complete with valves, H.T. and G.B. batteries, L.T. accumulator and 1 pair headphones.
Stevens, A. J., & Co. (1911), Ltd., Wolverhampton.	Symphony Three	Mahogany, table model, with compartment for batteries.	—	1	2	26 0 0	Complete with valves, H.T. battery, L.T. accumulator, aerial equipment and loud-speaker.
Tudoradio Co., Ltd. Tudor Works, Park Royal, London, N.W.10.	Tudoradio, D.C. Mains Model.	Mahogany	—	1	2	24 17 6	Complete with valves.
" " " "	Tudoradio, A.C. Mains Model.	"	—	1	2	27 17 6	"
Wilkins & Wright, Ltd., Kenyon Street, Birmingham.	Utility 3	Polished mahogany	—	1	2	12 6 6	Receiver only.
" " " "	"	"	—	1	2	18 0 0	Complete with H.T. battery, L.T. accumulator, valves and leads.
Ward & Goldstone, Ltd., Pendleton, Manchester.	Goltone A	Oak	—	1	2	7 15 0	Receiver only.
" " " "	"	"	—	1	2	12 17 6	Complete with valves, H.T. battery, L.T. accumulator and loud-speaker.
" " " "	B	"	—	1	2	15 7 0	Receiver only.
" " " "	"	"	—	1	2	10 17 6	"
" " " "	S	Mahogany	—	1	2	11 12 6	Complete with valves, H.T. battery, L.T. accumulator and loud-speaker.
" " " "	"	"	—	1	2	17 11 0	Receiver only.
Wootton, F. E., Ltd., 56, High Street, Oxford.	Wootphone D3	Polished oak	—	1	2	13 0 0	Complete with valves, H.T. and G.B. batteries, L.T. accumulator, aerial equipment and loud-speaker.
" " " "	"	"	—	1	2	20 0 0	Receiver only.

## MULTI-VALVE SETS

Manufacturer.	Name of Set.	Type of Cabinet.	Valves.			Price.	Description and Remarks.
			H.F.	Det.	L.F.		
Alphian Wireless, Ltd., 99, Mortimer Street, London, W.1.	Alphian	Oak, mahogany or lacquer.	1	1	2	£ s. d. 37 10 0	Complete with valves, H.T. battery and L.T. accumulator. Chinese lacquer, £2 10s. extra.
	"	"	2	1	2	43 2 6	"
	"	"	3	2	2	61 0 0	"
	"	"	"	—	—	4	90 0 0
Bamister & Fitton, 27, Millrow Road, Rochdale.	B. & F.	Fall front with hinged lid, 16in. x 8in. panel.	—	1	3	100 0 0 17 10 0	Receiver only.
Barnett & Soans, High Street, Kettering.	Barsonic	Mahogany moulded	—	1	3	23 12 0	Complete with 2 D.E.R. and 2 D.E.6 valves, 160 volt H.T. battery, accumulator and coils.
Bowyer, Lowe Co., Ltd., Letchworth, Herts.	7-valve Standard Super Heterodyne.	Vertical front with lid	3	2*	1	37 17 6	Complete with valves, H.T. battery, L.T. accumulator, headphones and loud-speaker.
	8-valve Standard Super Heterodyne.	"	3	2*	2	42 10 0	* 1 Oscillator. Receiver only.
	8-valve Control Model Super Heterodyne.	Sloping panel with writing-desk flap, on four legs. Valves and batteries enclosed.	3	2*	2	81 10 0	"
British Radio Corporation, Ltd., Weybridge.	B.R.C. 1-valve 200/2,000 metres.	Walnut, totally enclosed	1	1	2	30 13 0	Complete with valves, H.T. and L.T. batteries and loud-speaker.
	B.R.C. 1-valve long range.	Mahogany with doors	2	1	2	57 15 6	Neutralised H.F. complete with valves, H.T. and L.T. batteries and loud-speaker.
British Thomson-Houston Co., Ltd., Crown House, Aldwych, London, W.C.2.	B.T.H.	Self-contained, with enclosed L.S.	6-valve Super-Het.			134 0 0	Complete with valves, H.T. battery, L.T. accumulator, 1 pair headphones, coils for 300, 500, 1,500/1,800 and 2,400/3,000 metres. Two aerials (internal) are provided running at right angles to permit of reception in any direction without moving receiver.
H.S.A. Radio, Ltd., Small Heath, Birmingham.	B.S.A.	Mahogany or oak, sloping front with double doors.	1	1	2	27 10 0	Receiver only.

# Buyer's Guide to Sets

MULTI-VALVE SETS—continued.

Manufacturer.	Name of Set.	Type of Cabinet.	Valves.			Price.	Description and Remarks.
			H.F.	Det.	L.F.		
B.S.A. Radio, Ltd., Small Heath, Birmingham.	B.S.A. ....	Mahogany or oak sloping front with double doors.	1	1	2	£ s. d. 34 14 0	Complete with valves, H.T. battery and L.T. accumulator.
" " "	" .....	Do., Sloping front	Seven valves, comprising 1 oscillator, 2 int.-frequency amplifiers, 2 det. and 2 L.F. amplifiers.			65 17 6	Receiver only.
" " "	" .....	" .....	" .....			76 7 6	Complete with valves, H.T. batteries and L.T. accumulator.
Burndepr Wireless, Ltd., Eastnor House, Blackheath, London, S.E.3.	Ethophone Four	Mahogany.	1	1	2	29 3 6	Complete with 3 H.512 and 1 L.L.525 valves, coils, 280/325 metres, and 5X X and 1 telephone plug.
" " "	Luxe. de	Mahogany, double doors with lock-key.	1	1	2	31 13 6	" " " "
" " "	Ethodyne	Mahogany.	Seven valves, super-het., comprising oscillator, 1st det. int.-frequency amplifiers, 2nd det. low-frequency amplifiers.			70 12 6	Complete with 3 H.512, 3 H.L.512, 1 L.L.525 valves, telephone plug set, 7 instrument leads and frame aerials, 250/550 and 1,000/2,000 metres.
" " "	" de Luxe	Mahogany, double doors, lock and key	" .....			75 12 0	" " " "
Burne Jones & Co., Ltd., 296, Borough High Street, S.E.1.	Magnum Enclosed Four	Mahogany, with doors	—	1	3	18 5 0	Receiver only, without accessories, switching device for 3 or 4 valves, res. coupled, no plug-in coils needed.
C.A.C. Valve Distributing Co., Ltd., 10, Rangoon Street, Crutched Friars, E.C.3.	" "Elstree Six" Super IV.	Mahogany or fumed oak, American type.	3	1	2	32 15 0	Receiver only. Without accessories.
" " "	" .....	" .....	1	1	2	15 0 0	Receiver only.
" " "	" .....	" .....	1	1	2	21 2 0	Complete with valves, batteries, coils, 200/600 metres, and "Bullphone" loud-speaker.
Curtis, Peter, Ltd., 11, Red Lion Square, W.C.1.	Diodyne	Open	2	1	2	24 2 6	---
" " "	Enclosed	Enclosed	2	1	2	27 2 6	---
" " "	Double-circuit Super-Het.	Open, popular model.	8 valves.			46 5 0	---
" " "	" .....	Imperial model	" .....			61 5 0	---
Dynaergy Mains Supply, Staines.	Dynamo IV.	Mahogany.	1	1	2	24 10 0	Valves not included. L.T. and H.T. from D.C. Mains.
" " "	" .....	" .....	2	1	2	30 0 0	" " " "
Eagle Engineering Co., Ltd., Warwick.	Chakophone No. 7	Oak, vertical panel, compartment in base	1	1	2	18 7 3	Receiver and coils only.
" " "	" .....	" .....	1	1	2	30 2 3	Complete with aerial supplies, valves, batteries and Radiolux loud-speaker. Special cabinets extra, £1 to £9 15s.
Edison Bell, Ltd., 62, Glengall Road, Peckham, London, S.E.15.	Majestic	Oak, fitted with battery compartments on either side with lifting lid and closing doors.	1	1	2	17 10 0	Receiver only, with coils, 280/500 metres, H.F. detector with reaction, 1-stage transformer-coupled low-frequency amplification, 1-stage resistance-coupled low-frequency amplification.
" " "	" .....	Do., with twisted leg table.	1	1	2	20 10 0	" " " "
Edison Swan Electric Co., Ltd., 123/125, Queen Victoria Street, London, E.C.4.	Ediswan 4-valve Long Range Radiophone.	Polished walnut, upright with doors.	1	1	2	29 0 0	Receiver only, with H.T. and G.B. batteries and 1 pair range blocks.
" " "	" .....	" .....	1	1	2	37 1 2	As above but with following extras: 2 P.V.5D.E. valves, 2 A.R. valves, 100 ft. 7/22 aerial wire, 2 pairs moulded insulators, 1 12 in. lead-in tube, 3 yds. 10/26 S.W.G. earth wire, 1 6v. 70 a.h. actual accumulator in case, 1 earth clip and 1 pair headphones.
" " "	" .....	" .....	1	1	2	36 4 2	As above but with the following alterations: 2 P.V.5D.E. valves and 2 A.R. .06 valves in place of P.V.5D.E. and A.R. valves, 1 D.E.202 filament battery in place of 6v. 70 a.h. accumulator. Extra range blocks 18s. 6d. pair.
" " "	Ediswan Jacobean Receiver, 4-valve.	Jacobean oak	1	1	2	28 5 0	Receiver only, with 1 pair range blocks and H.T. and G.B. batteries.
" " "	" .....	" .....	1	1	2	36 4 6	Complete with above and X.W.27 accumulator 6v. 70 a.h. actual, 100 ft. 7/22 aerial wire, 2 pairs moulded insulators, 12 in. lead-in tube, 1 earth clip, 1 pair headphones, 2 P.V.5D.E. valves and 2 A.R. valves.
" " "	" .....	" .....	1	1	2	31 12 6	As above but with the following alterations: D.E.202 filament battery instead of X.W.27 accumulator and 2 P.V.5D.E. and 2 A.R. .06 valves in place of 2 P.V.5D.E. and 2 A.R. valves.
" " "	Ediswan Combined Jacobean Cabinet 4-valve Radiophone.	Jacobean oak, including receiver, loud-speaker all batteries, etc.	1	1	2	60 10 0	Receiver, with Televox loud-speaker, 2 60v. H.T. batteries, grid batteries, 1 pair headphones, 100 ft. 7/22 aerial wire, 2 pairs moulded insulators, 12 in. lead-in tube, 1 earth clip, 1 X.W.27 accumulator.

# Buyer's Guide to Sets

MULTI-VALVE SETS—continued.

Manufacturer.	Name of Set.	Type of Cabinet.	Valves.			Price.	Description and Remarks.
			H.F.	Det.	L.F.		
Edison Swan Electric Co., Ltd., 123/125, Queen Victoria Street, London, E.C.4.	Ediswan Combined Jacobean Cabinet 4- valve Radiophone	Jacobean oak, including receiver, loud-speaker all batteries, etc.	1 (Dual)	1 H.F.	2 Stage	63 3 0	As previous with 2 P.V.5D.E. valves and 2 A.R. valves.
"	"	"	1 (Dual)	1 H.F.	2 Stage	61 11 0	As above but with 2 P.V.5D.E. valves and 2 A.R. .06 valves and D.E.202 filament battery in place of N.W.27 accumulator. Extra range blocks, 18s. 6d. pair. Receiver only.
Ericsson Telephones, Ltd., 67/73, Kingsway, W.C.2.	0/1004 Long-range 4 0/1084 Enclosed 4	Sloping panel Mahogany cabinet, folding doors.	1	1	2	18 0 0	Complete with all accessories and loud-speaker incorporated.
"	0/1041 Cabinet	Queen Anne style	1	1	2	77 10 0	Complete with accessories and loud-speaker. Receiver only. First L.F. valve transformer-coupled; last valve choke-coupled. Can be used as 2-, 3- or 4-valve set. Receiver only.
Express Radio Co., Ltd., 46, High Holborn, W.C.1.	0/1048 Express No. 465	Upright cabinet Oak, vertical panel	1	1	2	42 10 0	Complete with aerial and earth equipment, H.T. and G.B. batteries, L.T. accumulator and 1 pair headphones.
Falk, Stadelmann & Co., Ltd., 83/93, Farringdon Road, London, E.C.1.	Nelson	Mahogany, sloping roll front.	1	1	2	30 0 0	Complete with aerial and earth equipment, H.T. and G.B. batteries, L.T. accumulator and 1 pair headphones.
"	Hood	Walnut slab	1	1	2	27 5 0	Receiver only.
"	Clive	Mahogany or oak, up- right.	1	1	2	21 10 0	Receiver only.
"	"	"	1	1	2	25 10 0	Complete with aerial and earth equipment, H.T. and G.B. batteries, L.T. accumulator and 1 pair headphones.
"	Marlborough	"	2	1	2	35 12 6	Receiver only.
Fallowfield, Jonathan, Ltd., 61/2, Newman Street, London, W.1.	Corner Cabinet 4-valve	Oak, to fit corner of room.	2	1	2	31 2 6	Complete with valves, H.T. batteries, L.T. accumulator, spare L.T. accumulator in carrying case, 1 pair headphones, enclosed loud-speaker and aerial equipment. Receiver only.
Garage, A. W., Ltd., Holborn, London, E.C.1.	Garage Super IV	American type	1	1	2	15 15 0	Complete with valves, H.T. and G.B. batteries, L.T. accumulator, 1 pair headphones and aerial equipment. Receiver only.
"	"	"	1	1	2	22 12 6	Complete with valves, H.T. and G.B. batteries, L.T. accumulator, 1 pair headphones and aerial equipment. Receiver only.
Gambrell Bros., Ltd., 76, Victoria Street, London, S.W.1.	Gambrell Cabinet Four	Polished mahogany, all enclosed, drop down flap covers operative panel; lower compart- ment has 2 doors for accumulator and batteries.	1	1	2	23 10 0	Receiver, with coils for local and 5XX. Embodies master switch. All controls are slow motion.
General Electric Co., Ltd., Magnet House, Kingsway, London, W.C.2.	4-valve Combination Geophone 5-valve B.C.2050.	Mahogany, ebonite panel, folding doors. Mahogany, with doors and compartment for batteries.	1	1	2	21 17 0	Set with valves and connecting coils and plugs only.
"	B.C.2051	"	1	1	3	35 2 6	Res.-capacity coupled. Set with valves and leads. Range, 272/770 metres.
"	Geophone 4-valve B.C.2740, table model	Mahogany, open front, hinged lid, mahogan- ite panel.	1	1	3	42 0 0	Set, as above, complete with H.T. and L.T. batteries.
"	B.C.2741	"	—	1	3	25 15 0	Choke-coupled set, with valves only.
"	B.C.2744 Cabinet Set No. 3.	Selected mahogany, with silver fittings, horizontal pattern, with enclosed L.S.	—	1	3	32 2 6	Set as above, complete with batteries and plugs.
"	B.C.2744 Cabinet Set No. 2.	Do., vertical pattern.	—	1	3	65 0 0	Complete with batteries, valves and loud-speaker. 230/3,100 metres.
"	B.C.2752 Cabinet Set No. 4.	Oak, with folding doors, loud-speaker, en- closed compartment for batteries.	—	1	3	55 0 0	"
"	Cabinet Model de Luxe	Mahogany, covered and fretted.	1	1	2	50 0 0	"
Gent & Co., Ltd., Faraday Works, Leicester.	Radiomatic "B."	Small, not self-con- tained.	1	1	2	84 10 0	Complete with valves, batteries, 4 pairs headphones and coils up to 3,000 metres. Receiver, with valves and coils.
"	"	Self-contained bureau type.	1	1	2	22 3 0	"
Gillilan Bros., Ltd., 63/4, High Holborn, London, W.C.1.	Gillan IV.	Oak or mahogany, ver- tical panel, valves and coils enclosed, lift-up lid, terminals at back.	1	1	2	30 10 0	"
"	"	"	1	1	2	15 2 0	Receiver only.
"	"	"	1	1	2	21 16 6	Complete with valves, H.T. battery, L.T. accumulator, battery leads, aerial and earth equipment, 1 pair headphones and coils for 300/700 metres.
"	Monodyne IV.	Oak or mahogany, with battery compartment and doors.	1	1	2	25 0 0	Receiver only.
"	"	"	1	1	2	31 3 3	Complete with valves, H.T. battery, L.T. accumulator, 1 pair headphones. No aerial and earth are required, but provision is made for external aerial or earth if desired. 1 main control.



# Buyer's Guide to Sets

MULTI-VALVE SETS—continued.

Manufacturer.	Name of Set.	Type of Cabinet.	Valves.			Price.	Description and Remarks.
			H.F.	Def.	L.F.		
Gilfillan Bros., Ltd., 63/4, High Holborn, London, W.C.1.	Gillan IV.X	Oak or mahogany, vertical panel, and coils enclosed, lift-up lid.	1	1	2	£ s. d. 22 10 0	Receiver only. D.C. mains. No batteries required.
" " "	" " " " " " " "	" " " " " " " "	1	1	2	26 9 0	Complete with valves, aerial and earth equipment, and coils for 300/700 metres. Receiver only.
Hart Collins, Ltd., 38a, Bessborough Street, London, S.W.1.	Spinet 4-valve	Cabinet, with loud-speaker embodied.	1	1	2	38 0 0	Complete with valves, batteries, headphones, loud-speaker and aerial supplies. Receiver only.
" " "	De Luxe 4-valve	Table model, with all batteries enclosed.	1	1	2	27 0 0	Complete with valves, batteries, headphones, loud-speaker and aerial supplies. Receiver only.
" " "	" " " " " " " "	" " " " " " " "	1	1	2	38 5 0	Complete with valves, batteries, headphones, loud-speaker and aerial supplies. Receiver only, with coils.
Henderson, W. J., & Co., Ltd., 351, Fulham Road, London, S.W.10.	H.R.4	Mahogany or oak, all enclosed.	1	1	2	18 10 0	Complete with valves, H.T. battery, L.T. accumulator, aerial equipment and leads and 1 pair headphones.
" " "	" " " " " " " "	" " " " " " " "	1	1	2	21 0 0	Complete with valves, batteries and coils (250/500 and Daventry). Receiver only.
Johnson, T. J., 17/19, Catherine Street, Salisbury.	Sarumphone 5-valve..	Mahogany 2-door	2	1	2	22 10 0	Complete with valves, batteries and coils (250/500 and Daventry). Receiver only.
Lamplugh, S. A., Ltd., King's Road, Tysley, Birmingham.	Super IV.	Oak, mahogany and walnut, batteries enclosed.	1	1	2	31 0 0	Complete with valves, batteries, 1 pair headphones and loud-speaker. Receiver, with valves only.
" " "	" " " " " " " "	" " " " " " " "	1	1	2	40 10 6	Complete with valves, batteries, 1 pair headphones and loud-speaker. Receiver, with valves only.
Langham (Diamond Clear) Radio, Albion House, New Oxford Street, W.C.	Langham	Plate glass	2	1	2	50 2 6	Receiver only.
M. A. P. Co., 246, Great Lister Street, Birmingham.	Major	Mahogany vertical panel	1	1	2	16 0 0	Complete with valves, batteries and accessories.
" " "	" " " " " " " "	" " " " " " " "	1	1	2	20 11 0	Receiver only, fitted with 4 Dimic coils and a switch to enable short or long wavelengths to be received. Grid bias battery and loud-speaker plug included.
McMichael, L., Ltd., Wexham Road, Slough.	The M.H. Dimic Four.	Mahogany and base to hold batteries.	1	1	2	18 5 0	Receiver only, with grid bias battery. The set by means of changeable autodyne units permits of reception of wavelengths from 40/5,000 metres.
" " "	The M.H. 7-valve Supersonic Receiver.	Mahogany, with feet and lid.	3	2	2	25 16 6	Receiver only, 1 valve reflexed. Complete with valves, H.T. and G.B. batteries, L.T. accumulator, leads and rejector.
Marconiphone Co., Ltd., 210/212, Tottenham Court Road, London, W.1.	Marconiphone V.B.4.	Mahogany	1	1	2	27 10 0	Receiver only.
" " "	" " " " " " " "	" " " " " " " "	1	1	2	37 0 6	Complete with valves, H.T. and G.B. batteries, L.T. accumulator, leads and rejector.
" " "	" " " " " " " "	" " " " " " " "	1	1	2	21 8 0	Receiver only.
" " "	" " " " " " " "	" " " " " " " "	1	1	2	27 18 6	Complete with valves, H.T. and G.B. batteries, L.T. accumulator, leads, rejector, 300/500 and 1,600 metres.
" " "	Sterling Anodion 4-valve Long Range.	Walnut, sloping deck	1	1	2	17 4 0	Receiver only.
" " "	" " " " " " " "	" " " " " " " "	1	1	2	24 9 2	Complete with valves, H.T. and G.B. batteries, L.T. accumulator, adaptable to wavelengths 40/5,000 metres.
" " "	Sterling 4-valve Receiver.	Walnut	1	1	2	28 19 8	" " " " " " " "
" " "	" " " " " " " "	" " " " " " " "	1	1	2	21 8 0	Receiver only.
" " "	Sterling 4-valve Floor Cabinet Type.	" " " " " " " "	1	1	2	62 10 0	Complete with valves, all batteries, leads (loud-speaker contained in cabinet), adaptable for 40/5,000 metres.
" " "	" " " " " " " "	" " " " " " " "	1	1	2	69 7 0	Receiver only.
" " "	Sterling Regina Receiver.	Oak	1	1	2	55 10 0	Complete with valves, all batteries, leads (loud-speaker contained in cabinet) adaptable for 40/5,000 metres.
" " "	" " " " " " " "	" " " " " " " "	1	1	2	42 7 0	Receiver only.
" " "	" " " " " " " "	" " " " " " " "	1	1	2	49 7 0	Complete with valves, all batteries, leads (loud-speaker contained in cabinet) adaptable for 40/5,000 metres.
" " "	Sterling Imperial Receiver.	Mahogany	1	1	2	42 10 0	Receiver only.
" " "	" " " " " " " "	" " " " " " " "	5	1	2	51 10 0	Complete with valves, all batteries and leads. Receiver only, with coils, 300/800 metres, 1 valve reflexed.
Marconiphons Straight Eight.	Marconiphons Straight Eight.	" " " " " " " "	1	1	2	66 11 0	Complete with (G) equipment, viz.: Bright and power valves, H.T. and G.B. batteries, 6v. L.T. accumulator, 1 pair headphones and aerial equipment and coils 300/800 metres.
Metro-Vick Supplies, Ltd., 155, Charing Cross Road, London, W.C.2.	Cosmos Universal	Simple hardwood case	1	1	3	22 5 0	Complete with (H) equipment, viz.: Dull emitter valves, H.T. and G.B. batteries, 2v. L.T. accumulator, 1 pair headphones and aerial equipment and coils 300/800 metres.
" " "	" " " " " " " "	" " " " " " " "	1	1	3	32 19 0	Without accessories.
" " "	" " " " " " " "	" " " " " " " "	1	1	3	30 17 6	Complete with (G) equipment as above. Complete with (H) equipment as above.
" " "	" " " " " " " "	Jacobean oak cabinet on legs.	1	1	3	28 10 0	Without accessories.
" " "	" " " " " " " "	" " " " " " " "	1	1	3	39 14 0	Complete with (G) equipment as above.
" " "	" " " " " " " "	" " " " " " " "	1	1	3	37 18 6	Complete with (H) equipment as above.
" " "	" " " " " " " "	Mahogany cabinet on legs.	1	1	3	30 10 0	Without accessories.

# Buyer's Guide to Sets

MULTI-VALVE SETS—continued.

Manufacturer.	Name of Set.	Type of Cabinet	Valves.			Price.	Description and Remarks.	
			H.F.	Det.	L.F.			
Metro-Vick Supplies, Ltd., Charing Cross Road, London, W.C.2.	Cosmos Universal	Mahogany cabinet on legs.	1	1	3	£ s. d. 41 11 0	Complete with (G) equipment as previous.	
	"	Jacobean oak cabinet with built-in L.S.	1	1	3	39 12 6	Complete with (H) equipment as above. Without accessories.	
	"	"	1	1	3	42 0 0	"	
	"	"	1	1	3	53 7 0	Complete with (G) equipment as above.	
	"	"	1	1	3	51 7 6	Complete with (H) equipment as above.	
	"	Mahogany cabinet with built-in L.S.	1	1	3	46 0 0	Without accessories.	
	"	"	1	1	3	57 9 0	Complete with (G) equipment as above.	
	"	"	1	1	3	55 7 0	Complete with (H) equipment as above.	
	"	Rich Jacobean oak cabinet with built-in L.S.	1	1	3	56 0 0	Without accessories.	
	"	"	1	1	3	67 9 0	Complete with (G) equipment as above.	
Midland Radiotelephone Co., Ltd., Brettell Lane Works, Stourbridge.	Mellowton	Box	1	1	3	55 7 6	Complete with (H) equipment as above. Receiver only.	
	"	Popular	1	1	3	74 9 0	Complete with (G) equipment as above.	
	"	Oak de luxe	1	1	3	71 7 6	Complete with (H) equipment as above.	
	"	Mahogany de luxe	1	1	3	22 10 0	Receiver only.	
	"	(All cabinets arranged to contain batteries, etc.)	1	1	2	26 10 0	"	
	"	Rexine	1	1	2	22 10 0	"	
	"	"	1	1	2	37 10 0	"	
	Ormsby & Co., Ltd., Ormsby Works, Lower Richmond Road, Rich- mond, Surrey.	Ormsby Extra Selective Long Range Receiver.	Rexine	1	1	1	25 0 0	"
	Oxford Wireless Telephony Co., Ltd., 22, Queen Street, Oxford.	Oxford Varsity Four	Dark mahogany, Radiation panel, nickel fittings.	1	1	2	27 10 0	Complete with valves, batteries, 1 pair head- phones, coils up to 1,600 metres and aerial supplies.
		Oxford Radiophone de Luxe.	Mahogany, Jacobean, with compartments for batteries.	1	1	2	52 10 0	Complete with valves, batteries, coils to 1,600 metres, headphones, loud-speaker and aerial supplies.
Prince's Electrical Clocks, Ltd., 173, New Bond Street, W.1.	Princcps Concert	Oak, walnut or mahog- any.	1	2*	1	22 0 0	*Trigger pair. Receiver only.	
	"	"	1	2*	1	31 10 0	Complete with valves, batteries and loud- speaker.	
Pye, W. G., & Co., Granta Works, Cambridge.	No. 710D	Walnut	1	1	2	20 0 0	Receiver only.	
	"	"	1	1	2	33 2 8	Complete with valves, batteries and loud- speaker.	
	No. 740	"	1	1	2	19 0 0	Receiver only.	
	"	"	1	1	2	32 2 8	Complete with valves, batteries and loud- speaker.	
	No. 750	Do., with compart- ment for batteries.	2	1	2	35 12 6	Receiver only.	
Radi-Arc Electrical Co., Ltd., Bennet Street, Chiswick, London, W.4.	Liberty	Oak or mahogany	8-valve Super Het.			38 10 0	Complete with valves, batteries, headphones and aerial supplies.	
	Elstree 6	"	6			32 10 0	Receiver only.	
	Liberty	"	6			35 17 6	"	
	Challenge 30	Oak, upright panel, folding doors.	5			28 2 6	Receiver only.	
	"	"	1	1	3	19 17 6	"	
Radiax, Ltd., 16, Palmers Place, Holloway Rd., N.7.	"	"	1	1	3	26 1 6	Complete with valves, batteries, headphones and aerial supplies.	
	"	Oak, upright panel	1	1	2	16 0 0	Receiver only.	
	"	"	1	1	2	20 18 0	Complete with valves, batteries, headphones and aerial supplies.	
	Radiax No. 33	Mahogany, with lid	1	1	2	13 5 0	Receiver only.	
	"	"	1	1	2	19 0 0	Complete with valves, batteries, headphones and aerial supplies.	
Radio Communication Co., Ltd., High Street, Barnes, S.W.	Polar Quartette	Oak, totally enclosed	—	1	3	15 0 0	Res.-Cap. Coupled. Set with grid-bias battery and aerial reaction unit for local and H.X. stations.	
	"	"	—	1	3	29 6 0	Complete with valves, batteries, aerial reaction units and loud-speaker.	
	Four	Mahogany, totally en- closed.	—	1	3	22 10 0	Receiver, with leads, remote-control unit, grid bias battery and aerial reaction units.	
	"	"	—	1	3	34 12 9	As above but with valves, L.T. battery and loud-speaker.	
	"	"	—	1	3	41 7 0	As above, but with H.T. accumulator.	
Radio Instruments, Ltd., 12, Hyde Street, London, W.C.1.	R.I.	Polished mahogany case, with doors and space for batteries.	1	1	2	24 0 0	Receiver only.	
	Superfone Maxum IV.	Mahogany, upright table model.	—	1	3	15 15 0	Tuned plate, 1 transformer and 2 res- coupled.	
Read & Morris, Ltd., 31, Eastcastle Square, Oxford Street, W.1.	Simplicity Five	Mahogany or walnut, enclosed.	2	1	2	50 0 0	Complete with valves, batteries, headphones and coils.	
	Carnter	Oak or mahogany	1	1	2	58 0 0	Receiver only. Single-dial tuning.	
R.M. Radio, Ltd., 19, Garrick Street, London, W.C.2.	"	"	1	1	2	51 0 0	Complete with valves, batteries and "Kone" loud-speaker.	

# Buyer's Guide to Sets

MULTI-VALVE SETS—continued.

Manufacturer.	Name of Set.	Type of Cabinet.	Valves.			Price.	Description and Remarks.
			H.F.	Det.	L.F.		
Sherman, P., 12, River Street, London, E.C.2.	Claremont 4	Oak, American type with doors.	1	1	2	£ 18 0 0	Complete with valves, H.T. battery, L.T. accumulator and loud-speaker.
	Claremont 5	"	2	1	2	24 0 0	Complete as above, but loud-speaker enclosed and entirely self-contained, 1 calibrated dial control and tuning charge.
	Claremont de Luxe	Oak pedestal	1	1	2	40 0 0	Complete as above, but with large capacity accumulator, H.T. accumulator with switching for last 2 valves and remote control unit.
Stevens, A. J. & Co. (1914), Ltd., Wolverhampton.	Symphony Seven	Mahogany bureau table model.	7-valve Super-Het.			67 10 0	Complete with valves, loud-speaker, batteries and aerial equipment (frame aerial).
	Symphony Five	"	5	"	"	60 0 0	"
Terry, Herbert & Sons, Ltd., Redditch.	Terry Four	Table, model oak	1	1	2	39 0 0	Receiver only with valves. Mahogany cabinet, £1 extra.
	"	"	1	1	2	50 0 0	Complete with valve, H.T. battery, L.T. accumulator and loud-speaker.
	"	Cabinet model oak	1	1	2	46 10 0	Receiver only with valves. Mahogany cabinet, £2 extra.
	"	"	1	1	2	57 10 0	Complete with valve, H.T. battery, L.T. accumulator and loud-speaker.
Truphonic Wireless Co., 189, Regent Street, London, W.1.	Truphonic	Square, enclosed	—	1	3	15 2 0	Complete with valves, H.T. and G.B. batteries. L.T. accumulator and loud-speaker, all enclosed in the receiver.
Ward & Goldstone, Ltd., Pendleton, Manchester.	Goltone de Luxe	Mahogany, totally enclosed.	1	1	2	25 5 0	Receiver only.
	"	"	1	1	2	32 17 6	Complete with valves, H.T. battery. L.T. accumulators and loud-speaker.
	Goltone, Type "S"	Mahogany	1	1	3	30 5 0	Receiver only.
	"	"	1	1	3	21 12 6	"
	Goltone de Luxe	Oak, totally enclosed	1	1	3	28 2 6	Complete with valves, H.T. batteries, L.T. accumulators and loud-speaker.
	"	"	1	1	3	38 5 0	"
	"	Mahogany, totally enclosed.	1	1	3	39 15 0	"
	Goltone, Type "A"	Oak	1	1	3	29 12 6	Receiver only.
	"	"	1	1	2	11 2 6	Complete with valves, H.T. battery, L.T. accumulators and loud-speaker.
	"	"	1	1	2	16 2 0	"
White & Ritchie, 104, Raeburn Place, Edinburgh.	Goltone, Type "B"	"	1	1	2	17 17 6	Receiver only.
	Goltone, Type "S"	Mahogany	1	1	2	13 0 0	"
	"	"	1	1	2	15 5 0	Complete with valves, H.T. battery, L.T. accumulators and loud-speaker.
	"	"	1	1	2	23 0 0	"
	Goltone de Luxe	Jacobean oak, totally enclosed.	1	1	2	32 2 0	Receiver only.
	"	"	1	1	2	24 5 0	Receiver only, H.F. transformer coupled. Litz wound secondaries on skeleton formers.
Williamson, Robert, 56, Commercial Street, Lerwick, Shetland Isles.	M.R. Neutro-path V.	French polished mahogany, American type.	2	1	2	67 10 0	Complete with valves, H.T. and G.B. batteries, L.T. accumulator and loud-speaker.
	"	"	2	1	2	67 10 0	Complete with valves, H.T. and G.B. batteries, L.T. accumulator, 2 pairs headphones, loud-speaker and aerial and earth equipment.
Wilkins & Wright, Ltd., Kenyon Street, Birmingham.	Thulephone	American type	1	1	2	34 0 0	Receiver only.
	Utility 4	Polished mahogany	1	1	2	12 18 6	Complete with H.T. battery, L.T. accumulator, valves and leads.
Wooten, F. E., Ltd., 56, High Street, Oxford.	Wootophone "J"	Jacobean	1	1	2	39 18 0	Complete with enclosed loud-speaker valves, H.T. and G.B. batteries, L.T. accumulator and coils 300/3,000 metres, 1 pair headphones.
	Wootophone "F"	Oak or mahogany upright.	1	1	2	48 6 0	"
	Wootophone "G"	Oak or mahogany table cabinet.	1	1	2	30 18 0	Complete with valves, H.T. and G.B. batteries, L.T. accumulator, aerial equipment and headphones.
Yorkshire Radio Co., Western Works, Rockingham Street, Sheffield.	Deucalion	All types	1	1	2	30 0 0	Receiver only.



## PORTABLE SETS



Manufacturer.	Name of Set.	Type of Cabinet.	Aerial.	Valves.			Price.	Description and Remarks.
				H.F.	Det.	L.F.		
Alphian Wireless, Ltd., 99, Mortimer Street, London, W.1.	Alphian	Oak, mahogany, leather or lacquer.	—	—	1	—	£ 10 0 0	Complete with valves and batteries. No aerial or earth required.
				—	1	1	From 15 12 6	

# Buyer's Guide to Sets

## PORTABLE SETS—continued.

Manufacturer.	Name of Set.	Type of Cabinet.	Aerial.	Valves.			Price.	Description and Remarks.
				H.F.	Det.	L.F.		
Alphian Wireless, Ltd., 99, Mortimer Street, London, W.1.	Alphian .....	Oak, mahogany, leather or lacquer.	—	—	1	2	£ s. d. 26 17 6	Complete with valves and batteries. No aerial or earth required.
	" .....	" .....	—	1	1	2	37 10 0	
	" .....	" .....	—	2	1	2	43 2 6	
Auto Sundries, Ltd., 10, Lower Grosvenor Pl., London, S.W.1.	R.S.N. ....	Walnut, oak or mahogany.	A	Five valves ..			18 10 0	Complete with valves, batteries and loud-speaker.
British Thomson-Houston Co., Ltd., Crown House, Aldwych, London, W.C.2.	B.T.H. ....	Leather finish with 2 hinged doors.	A	Three-valve super-het.			21 0 0	Complete with valves, H.T. battery, L.T. accumulator, 1 pair headphones. Waterproof case 16s. extra. Frame aerial £3 10s. extra.
	" .....	Mahogany with 2 hinged doors.	A	"			23 2 6	
	B.T.H. Portable Amplifier and Loud-speaker for above.	Leather finish with 2 hinged doors.	—	2 power valves			25 2 6	
Burne-Jones & Co., Ltd., 296, Borough High Street, S.E.1.	Magnadyne 8-Valve Super-het.	Mahogany .....	B	Eight			16 5 0	Complete with valves, H.T. battery and L.T. accumulator.
	" .....	" .....	—	"			18 5 0	
	All-season Portable ..	Leather case, wooden sub-frame.	C	1	1	1	31 10 0	
Butterfields, Ltd., Levis Motor Works, Stechford, Birmingham	Levis .....	" .....	—	1	1	2	17 12 6	Including folding frame aerial, oscillator, H.F. transformer and loading coil for higher wavelength. 8 special valves. Switching device for 4-valve or 8-valve super-het.
	C.A.C. Valve Distributing Co., Ltd., 10, Rangoon Street, Crutched Friars, E.C.3.	C.A.C. Portable .....	A	1	1	2	23 10 0	
	Cahill & Co., Ltd., 64, Newman Street, London, W.1.	Pelican .....	Mahogany .....	B	—	1	22 10 0	
Cantophone Wireless Co., 310, Regent Street, London, W.1.	Cantophone .....	Leather attaché case ..	B	—	1	1	40 0 0	Complete with valves, H.T. battery, and L.T. accumulator.
	" .....	" .....	B	—	1	1	19 5 0	
	" .....	" .....	B	—	1	2	21 0 0	
Celestion Radio Co., 29/31, High Street, Kingston-on-Thames.	Radiofour .....	Leather attaché case ..	A	2	1	2	40 0 0	Complete with valves, H.T. battery, L.T. accumulator and 1 pair headphones. Complete with valves, H.T. battery, L.T. accumulator and loud-speaker.
	" .....	" .....	—	—	1	2	40 0 0	
	" .....	" .....	—	—	1	2	20 15 6	
Celestion Radio Co., 27/27, High Street, Hampton Wick.	Radiofour .....	Mahogany or oak .....	A	1	1	2	27 10 0	Complete with all accessories. Resistance capacity, L.F. amplification. No reaction or L.F. transformers or chokes. (Low wavelength only). Ditto (Low wavelength and 5XX.) Ditto Ditto Ditto
	" .....	" .....	A	1	1	2	35 0 0	
	" .....	" .....	A	1	1	2	35 0 0	
Colbery, C. T., & Co., Ltd., 8/9, Clerkenwell Green, London, E.C.1.	Idea! .....	Black leather .....	A	1	1	2	39 0 0	Resistance capacity, L.F. amplification. (Low wavelength only) Ditto. (Low wavelength and Daventry.) Complete with H.T. and G.B. batteries, L.T. accumulator valves, 1 pair headphones and 7 coils. Receiver only. Dual valve. Complete with frame aerial valve, H.T. battery, L.T. accumulator and headphones.
	" .....	" .....	A	—	1	2	20 0 0	
	" .....	" .....	—	—	1	—	6 12 6	
Climax Radio Electric, Ltd., Quill Works, Putney, London, S.W.16.	Climax Monovalve ..	Oak .....	B	—	1	—	10 4 0	Complete with frame aerial valve, H.T. battery, L.T. accumulator and headphones. Complete with valves, batteries and loud-speaker.
	" .....	" .....	B	—	1	—	10 4 0	
Curtis, Peter, Ltd., 11, Red Lion Square, London, W.C.1.	Duodyne Portable IV Double-circuit Super-Het. 8	Oak .....	A	1	1	2	27 10 0	Complete with valves, batteries and loud-speaker.
	" .....	" .....	A	8 valves			58 15 0	
Eagle Engineering Co., Ltd., Warwick.	Chakophone Portable Super-Het.	Leather covered .....	A	3	2	2	56 0 0	Oscillator. Set complete with batteries and built-in loud-speaker.
Edison Swan Electric Co., Ltd., 123/125, Queen Victoria Street, London, E.C.1.	Ediswan Portable Toovee Radiophone, leather carrying handle.	Hardwood case covered with black leatherette	C	—	1	1	11 5 0	1 Dual valve, complete with H.T. and G.B. battery, L.T. accumulator and 2 pairs headphones. Range 300/300 metres.
Engineering Works (Electrical & General), Ltd., 7-8, Great Winchester Street, London, E.C.2.	Rayol IV .....	Leather, oak or mahogany.	A	1	1	2	12 13 0	As above, but with 2 AR.06 valves. Complete with valves, batteries, loud-speaker, switch for 3 or 1 valves and change-over switch for short or long wavelengths.
	" .....	" .....	A	1	1	2	32 10 0	
General Electric Co., Ltd., Magnet House, Kingsway, W.C.2.	Geophone 7-valve Portable Supersonic, B.C. 7,000.	Oak, 21 in. x 15 in. x 9½ in.	A	3	2	2	50 0 0	Complete with valves, batteries, and built-in loud-speaker; range 230-2,800 metres. Complete with valves, batteries, accumulator in mahogany case, phones, and oscillator; range up to 3,000 metres; short-wave (38-230 metres) frame-aerial and oscillator extra.
	8-Valve Super-het., B.C. 8,800.	Mahogany, with hinged lids.	B	3	3	2	73 10 0	
	8-Valve Super-het. Uni-control.	Mahogany, with panel	B	3	3	2	75 0 0	
Geut & Co., Ltd., Faraday Works, Leicester.	Radiomatic "B" .....	Small, oak or mahogany.	C	—	1	1	13 10 8	Complete with valves, coils, H.T., G.B., and L.T. batteries, and loud-speaker.
	" .....	Self-contained, mahogany or oak.	C	—	1	1	14 19 8	
Gillilan Bros., Ltd., 63-64, High Holborn, London, W.C.1.	Gillilan Ubique IV L.S.	Solid hide suitcase ..	A	1	1	2	25 0 0	Complete with valves, H.T. and G.B. batteries, L.T. accumulator, internal frame with provision for external aerial and earth, built-in loud-speaker and provision for headphones or external loud-speaker.
	" .....	" .....	A	1	1	2	22 10 0	

# Buyer's Guide to Sets

## PORTABLE SETS—continued.

Manufacturer.	Name of Set.	Type of Cabinet.	Aerial.	Valves.			Price.	Description and Remarks.
				H.F.	Det.	L.F.		
Gladwell & Kell, Ltd., 258, Gray's Inn Road, London, W.C.1.	Liquitone .....	—	C	1	1	2	£ s. d. 25 4 6	Receiver with valves.
	" .....	—	C	1	1	2	35 0 0	Complete with valves, H.T. batteries, L.T. accumulator in carrying case, and loud-speaker.
Halyon Wireless Supply Co., Ltd., 110, Knightsbridge, London, S.W.1.	Halyon Five .....	Oak .....	A	2	1	2	40 0 0	Complete with valves, H.T. battery, L.T. accumulator and self-contained loud-speaker.
	" .....	Mahogany .....	A	2	1	2	41 10 0	" .....
	" .....	Oak .....	A	2	1	1	30 0 0	" .....
	" .....	Mahogany .....	A	2	1	1	31 10 0	" .....
Hart Collins, Ltd., 28a, Bessborough Street, S.W.1.	" .....	Leatherette .....	A	—	1	2	20 0 0	" .....
	Portable 4-Valve .....	Attaché case type .....	B	1	1	2	22 10 0	Receiver only.
	" .....	" .....	B	1	1	2	27 4 6	Complete with valves and batteries.
	Orthosonic 8-Valve .....	Table model .....	B	3	3*	2	50 15 0	* 1 Det., 1 oscillator, 1 modulator. Set only, with aerial.
Hoare & Jagels, 28-29, Great Sutton Street, Clerkenwell, London, E.C.1.	" .....	" .....	B	3	3*	2	68 0 0	Complete with valves, batteries, headphones, loud-speaker and aerial.
	" .....	" .....	B	3	3*	2	61 0 0	* 1 Det., 1 oscillator, 1 modulator. Receiver only with aerial.
	Super-het Spinnet 8-Valve .....	Cabinet model, with loud-speaker enclosed .....	B	3	3*	2	73 10 0	Complete with valves, batteries, headphones, loud-speaker and aerial.
	" .....	" .....	B	3	3*	2	73 10 0	Complete with valves, batteries and 1 pair headphones.
Hoare & Jagels, 28-29, Great Sutton Street, Clerkenwell, London, E.C.1.	Rolls Portable 2V .....	Leather attaché case .....	A	—	1	2	14 11 0	Complete with valves, batteries and 1 pair headphones.
	" .....	" .....	A	—	1	2	18 10 0	" .....
	" .....	" .....	A	—	1	2	23 2 0	Complete as above, but with loud-speaker incorporated.
	" .....	" .....	A	2	1	2	27 6 0	Complete with valves, batteries and 1 pair headphones.
Igranic Electric Co., Ltd., 149, Queen Victoria Street, E.C.4.	" .....	" .....	A	2	1	2	31 10 0	Complete as above, but with loud-speaker incorporated.
	Igranic Neuro-sonic Seven Super-het. .....	Leatherette covered, nickel-plated fittings .....	B	4	2*	1	45 17 6	* 1 Det., 1 oscillator. Complete with valves, spare long-wave unit, and 1 pair headphones.
	" .....	" .....	B	4	2*	1	49 7 6	As above, but with Igranic 4-section frame aerial. (300/1,800 metres.)
	" .....	" .....	B	4	2*	1	50 18 0	As above, but with 4-section aerial and carrying case and separate battery box. Complete with valves and loud-speaker.
Langham (Diamond Clear) Radio, 50-61, New Oxford Street, W.C. Midland Radiotelephone Co., Ltd., Brettell Lane Works, Stourbridge.	Langham .....	Leather .....	A	1	1	2	31 10 0	1 Dual valve. Complete with H.T. and G.B. batteries, valves, loud-speaker, 2-frame aerials, 5NX and long-wave coil.
	Mellowtone .....	Leather .....	B	1	1	1	20 17 6	Complete with valves, batteries and "Dragonfly" loud-speaker.
M.P.A. (Wireless), Ltd., 62, Conduit Street, London, W.1.	M.P.A. Stationary Two .....	Mahogany .....	C	—	1	1	10 10 0	Complete with valves, batteries and "Dragonfly" loud-speaker.
	M.P.A. Inclusive Three .....	Leatherette, mahogany or oak .....	A	—	1	2	16 16 0	Complete with valves, batteries, loud-speaker and coils for Daventry.
	" .....	" .....	A	—	1	2	17 17 0	" .....
	" .....	" .....	A	—	1	2	18 18 0	" .....
	M.P.A. Self-contained Four .....	Leatherette .....	A	1	1	2	21 0 0	Complete with valves, batteries and incorporated loud-speaker.
	M.P.A. Self-contained Super Five .....	Mahogany .....	A	2	1	2	33 12 0	Complete with valves, batteries, incorporated loud-speaker and coils for Daventry.
	M.P.A. Inclusive Six de Luxe .....	" .....	A	2	1	3	47 5 0	Complete with valves, batteries, "Cestation" loud-speaker and coils for Daventry.
	Em-pe-a-Adyne .....	Oak, walnut or mahogany .....	A	2	1	3	73 10 0	Complete with valves, batteries, incorporated loud-speaker and coils for Daventry.
Oxford Wireless Telephony Co., Ltd., 22, Queen Street, Oxford.	Oxford 1-Valve .....	Polished mahogany .....	C	—	1	—	8 0 0	Complete with valve, batteries, coils up to 1,000 metres and aerial supplies.
	Oxford Portable .....	Mahogany or oak, nickelled fittings .....	A	1	1	2	32 10 0	Complete with valves, batteries, loud-speaker incorporated. Provision for outdoor aerial and earth.
Prince's Electrical Clocks, Ltd., 173, New Bond Street, W.1. Pye, W. G. & Co., Granta Works, Cambridge.	Princept Transportable .....	Oak or mahogany .....	A	2	1	2	37 10 0	* Trigger pair. Complete with valves, batteries and loud-speaker.
	No. 555 .....	Walnut .....	A	2	1	2	30 12 6	Complete with valves and batteries.
Radio-Arc Electrical Co., Ltd., Bennett Street, London, W.4.	Liberty Portable 2 .....	Black leatherette case .....	B	7-Valve Super-het.	—	—	35 5 6	Complete aerial and H.T. and L.T. batteries.
	Liberty Portable 4 .....	" .....	B	4-Valve.	—	—	22 10 0	" .....
Radio Instruments, Ltd., 12, Hyde Street, London, W.C.1.	New Lyriantette .....	Polished mahogany with compartment for batteries .....	A	—	1	2	27 9 6	Complete with H.T. and L.T. batteries, valves, and loud-speaker.
	Rotola Portable .....	Leatherette, built-in loud-speaker .....	A	1	1	1	21 17 6	With valves and batteries.
Rotax (Motor Accessories), Ltd., Wilkesden Junction, N.W.10. Rees Mace Manufacturing Co., Ltd., 30c, Welbeck Street, W.	2-Valve, All-in .....	Mahogany, oak or ebonyised .....	B	—	1	1	16 16 6	Complete with valves and batteries.
	3-Valve, All-in .....	" .....	B	—	1	1	21 0 0	" .....
	4-Valve, All-in .....	" .....	B	1	1	2	26 5 0	" .....
	8-Valve Heterodyne, All-in .....	" .....	B	3	3*	2	65 2 0	* 2 Det., 1 oscillator. Complete with valves and batteries.
P. Sherman, 12, River Street, London, E.C.1.	Claremont Portable Two .....	Fibre carrying case .....	C	—	1	1	6 0 0	Complete with H.T. battery, L.T. accumulator, valves, 1 pair headphones and aerial.
	Claremont Portable Three .....	" .....	C	1	1	1	10 0 0	Complete with H.T. battery, L.T. accumulator, valves, aerial and loud-speaker.
	Claremont Portable Four .....	" .....	B	1	1	2	18 0 9	" .....



## PORTABLE SETS—continued.

Manufacturer.	Name of Set.	Type of Cabinet.	Aerial.	Valves.			Price.	Description and Remarks.
				H.F.	Det.	L.F.		
P. Sherman, 12, River Street, London, E.C.1.	Claremont Portable Four de Luxe.	Leather case	B	1	1	2	£ 25 0 0	Complete with H.T. battery, L.T. accumulator, valves, aerial and loud-speaker.
Siemens Bros. & Co., Ltd., Woolwich, London, S.E.18.	Siemens M.T.P.	Mahogany, revolving on turntable.	A	1	1	1	15 17 6	Complete with valves, H.T. and L.T. batteries, and 1 pair headphones.
Whittingham, Smith & Co., 4a, St. Mary's Square, Ealing, London, W.5.	Portadyne V.	Mahogany or oak	A	2	1	2	35 0 0	Complete with H.T. battery, L.T. accumulator, valves, and loud-speaker.
"	Portadyne IV.	"	A	2	1	2	30 0 0	Ditto, without loud-speaker.
"	Portadyne III.	Oak	A	1	1	2	22 10 0	Ditto, with loud-speaker.
"	"	"	A	1	1	2	16 16 0	Ditto, without loud-speaker.

The nature of aerial is indicated by the following letters:—

A—Frame type in lid or body of receiver.

B—Separate frame aerial.

C—Portable aerial for suspending from a tree or post.

## AMPLIFIERS.

Manufacturer.	Name of Set.	Type of Cabinet.	Valves.		Price.	Description and Remarks.
			H.F.	L.F.		
Alphian Wireless, Ltd., 99, Mortimer Street, London, W.1.	Alphian	Oak, mahogany, or lacquer.	—	1	£ 10 0 0	Complete with valve and batteries, self-contained.
"	"	"	—	2	20 0 0	" valves " "
"	"	"	—	3	25 0 0	" " " "
Bannister & Fitton, 27, Milnrow Road, Rochdale.	B. & F.	Upright cabinet, 8 in. x 8 in. vertical panel.	—	2	7 4 0	Valves extra.
British and Colonial Industries Association, Ltd., 329, High Holborn, London, W.C.1.	B.C.1 Mark III Amplifier.	Polished oak	—	1	9 9 0	Complete with valves.
British Thomson-Houston Co. Ltd., Crown House, Aldwych, London, W.C.2.	B.T.H. Single Stage	Walnut, flat top, sunken valve.	—	1	3 12 6	Amplifier only.
"	Two Stage	"	—	2	6 17 6	" " (no royalties).
Brownie Wireless Co. of Gt. Britain, Ltd., Nelson Street Works, Arlington Road, London, N.W.1.	Brownie Two Stage	Solid one-piece moulding.	—	2	3 3 0	" " (no royalties).
Butternolds, Ltd., Levis Motor Works, Stechford, Birmingham	Levis	"	—	1	6 7 6	"
Cantophone Wireless Co., 310, Regent Street, London, W.1.	Cantophone	Polished mahogany	—	1	3 5 0	Amplifier only, size 6x6x6 inches.
"	"	"	—	2	6 5 0	size 12x6x6 inches.
Eagle Engineering Co., Ltd., Warwick.	Chakophone No. 9A	Oak, vertical panel	1	—	3 17 6	Amplifier only.
"	"	"	1	—	4 11 0	With valve.
"	No. 9B	"	1	1	4 2 6	Amplifier only.
"	"	"	1	1	4 16 6	With valve.
"	No. 2A	"	2	2	5 15 0	Amplifier only.
"	"	"	2	2	7 3 0	With valves.
"	"	"	1	1	2 17 6	Amplifier only.
Edison Swan Electric Co., Ltd., 123/5, Queen Victoria Street, London, E.C.4.	Ediswan	Cube type with ebonite panel carrying valve and terminals.	—	1	5 0 7	Complete with valve, 2 pairs porcelain insulators, 1 9m. lead-in tube, 100ft. 7/22 aerial, and 3 yds. 19/26 earth wire, H.T. battery, and 1 D.E.200 dry battery for filament lighting. Provision made inside cabinet for a G.B. battery.
"	"	"	—	1	5 0 7	Amplifier only.
Eriesson Telephones, Ltd., 67/73, Kingsway, W.C.2.	0/1055	Sloping panel	—	2	6 5 0	Amplifier only.
Gamage, A. W., Ltd., Holborn, London, E.C.1.	G.S.9	American type	—	1	3 2 6	Amplifier only.
"	G.S.10	"	—	2	5 9 0	"
Henderson, W. J. & Co., Ltd., 351, Fulham Road, London, S.W.10	BBA1	Oak, open	—	1	2 12 6	"
"	BA2	"	—	2	4 10 0	"
Igranite Electric Co., Ltd., 149, Queen Victoria Street, E.C.4.	Igranite 3-Valve Res. Coupled.	Moulded Bakelite case	—	3	4 7 6	Without valves or accessories.
Johnson, T. J., 17/19, Catherine Street, Salisbury.	Sarunophone Amplifier.	Mahogany box	—	1	1 10 0	Valve extra.
Marconiphone Co., Ltd., 210/212, Tottenham Court Road, London, W.1.	Marconiphone H3	Mahogany	1	—	3 2 6	Amplifier only.
"	"	"	1	—	4 2 6	With valve and leads.
"	A4	"	1	—	4 16 6	Amplifier only.
"	"	"	1	—	5 9 3	With valve, grid bias, and leads.
"	B2 (Power)	"	2	—	8 5 0	Amplifier only.
"	"	"	2	—	17 19 0	With valves, all batteries, and leads.
"	A2 (Voice)	"	2	—	9 5 0	" " " "
"	"	"	2	—	9 5 0	" " " "
Metro-Vick Supplies, Ltd., 155, Charing Cross Road, London, W.C.2.	Cosmos A5	Hardwood case	—	3	5 9 0	Amplifier only.
"	"	"	—	3	9 15 0	"
New Wilson Electrical Manufacturing Co., Ltd., 18, Fitzroy Street, Euston Road, W.1.	Magnetic Microphone Bar.	Small round base	—	—	1 18 "	No valves required.
Pye, W. G., Ltd., Granta Works, Cambridge.	No. 225	Walnut	—	1	3 2 6	Amplifier only.
"	"	"	—	1	4 3 3	Complete with valve and battery.
Radiax, Ltd., 16, Palmer Place, London, N.7.	Radiax No. 2	"	—	1	2 10 6	Amplifier only.
"	No. 2A	"	—	2	3 18 0	"
Radio Communication Co., Ltd., High Street, Barnes, S.W.	Polar Dual	"	—	2	5 5 0	Res.-Cap. Coupled. Amplifier and battery leads only.
Radio Instruments, Ltd., 12, Hyde Street, London, W.C.1.	R.I.	Polished mahogany	—	1	5 15 0	Amplifier only.
"	"	"	—	2	8 17 6	"
Service Radio Co., Ltd., 62, Church Street, Stoke Newington, London, N.16.	Modern 1-Valve	Mahogany tray	—	1	1 0 0	"
"	2-Valve	"	—	2	1 10 0	"
Siemens Bros. & Co., Ltd., Woolwich, London, S.E.18.	Siemens	Mahogany, with lid	—	1	3 15 6	Complete with valve, H.T. and G.B. batteries, and L.T. accumulator.
"	S.B.59 (Power)	"	—	1	6 18 6	"



# Broadcast Brevities

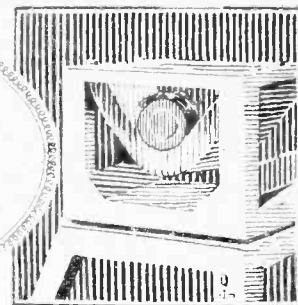

News from All Quarters: By Our Special Correspondent.

**"Let Your Friends Listen"—The Fourteenth—The Etherial Jungle—A Fish Story—  
—Underpaid Artists—The Programme Sleuth.**

**The Great Moment.**

Have you "let your friends listen"? Now is the time.

o o o o

**The Fourteenth.**

As announced in *The Wireless World* last week, the Geneva wavelength changes will come into effect on Sunday next, November 14th.

Some dislocation is almost bound to occur, but we can all bear in mind that the ultimate aim of the scheme is simply to obtain satisfaction for the listener by introducing stability and order in place of chaos.

o o o o

**What Happens in Britain.**

A complete list of the changes to be made by British and Continental stations appeared in *The Wireless World* of September 1st.

The following list shows the revision taking place among the British stations:—

	New.	Old.
Aberdeen	481.8	495
Birmingham	479	479
Glasgow	405.4	422
Belfast	326.1	440
London	361.4	365
Newcastle	312.5	404
Manchester	384.6	378
Bournemouth	306.1	386
Cardiff	353	353
Leeds	297	321
Bradford	294.1	310
All other relays	288.5	—

**A Strange Coincidence.**

Some surprise may be felt by many listeners, especially in the London area, when they find that the changes involve little or no alteration to the tuning of their sets.

To the chappies who own reliable wave-meters it will be no news, perhaps, that 2LO has for several months past been working well below its official wavelength of 365 metres—in fact, as low as 361.4 metres. The "new" wavelength is 351.4 metres. This is a strange coincidence, as the beginner said when he burnt out four valves simultaneously.

**Anticipation.**

Several foreign stations have also been anticipating the Geneva scheme. The other night I heard Leipzig, which has no lawful business on anything but 452 metres, breaking into song on 321 metres. This wavelength has been used for some time, I believe, and is fairly near the new wavelength of 322.6.



**THE MAN AND THE METER.** Captain P. P. Eckerstey, Chief Engineer of the B.B.C., is obviously fascinated by 2LO's new wavemeter, which has been calibrated in Brussels against a harmonic tuning fork instrument. The wavemeter was described on page 602 of our last issue.

**The Etherial Jungle.**

An idea of the chaotic jungle into which the European ether has developed under the old régime can be gained by studying the adventures of Cardiff.

The drama begins, not in the flourishing Welsh town, but in the capital of Spain.

Radio Iberica, Madrid, which owns the

wavelength of 392 metres, temporarily closed down. Seville, normally working on 350, immediately "pinched" the 392-metre wavelength. A station at present unknown thought this too good a chance to miss, so it fastened on the unoccupied wavelength of 350 metres. This reacted unpleasantly on gentle Marseilles, with its wavelength of 351 metres. Marseilles was forced to shift, with the result that Cardiff was heterodyned.

Let us hope that the unprincipled unknown station has fused its aerial.

o o o o

**More Manœuvres.**

Another little drama of the same kind has involved Plymouth. Anticipating Geneva, the Naples station jumped from 350 to 333.3 metres, and then produced further complications by changing to 338. This affected Madrid III., working on 340, and Madrid's defensive move resulted in the heterodyning of the Devon station.

Will Saturday see the last of these dazzling manœuvres? Ask me next week!

o o o o

**A Bourchier Broadcast.**

Mr. Arthur Bourchier will broadcast from 2LO on November 28th.

o o o o

**Birmingham's Birthday.**

Birmingham station celebrates its fourth birthday on Monday next, November 15th. The second half of the programme on that evening will consist of varied items by the station staff, chorus, and orchestra.

o o o o

**Not a Light Programme.**

For two or three seconds confusion reigned in the Bournemouth studio during the recent birthday programme. Everything was going well and the orchestra was playing Captain Featherstone's waltz, "Bournemouth Calling," when suddenly the lights went out. After a momentary consternation, however, the orchestra continued playing, assisted by the singing of the studio audience. The studio remained in darkness for several minutes.

**A Fish Story.**

On the same night the birthday programme was enjoyed by a fishing party cruising with a portable set and loud-speaker in the Solent. A member of the expedition wrote to say that the excellence of the music resulted in a record catch! A little "fishy," what? Or were the fish driven to suicide?

○○○○

**Christmas Plans.**

No definite programme arrangements have yet been completed for the Christmas season, though I learn that a playlet with a Yuletide flavour has been prepared by Miss Mabel Constanduros.

○○○○

**Blind Visit to 2LO.**

On Saturday next Captain Eckersley is showing a party of St. Dunstan's men round the London studios. It may seem strange, perhaps, that blind men should take an interest in "seeing" the studios, but they have already toured various places of note in London, and being keen listeners are anxious to include the broadcasting station in their itinerary. Captain Ian Fraser, the blind M.P. and wireless experimenter, will accompany the party.

○○○○

**A Chance for the Corporation.**

Last week Savoy Hill received 179 complaints regarding oscillation. The trouble has been traced to 27 districts.

If the new corporation can propound a satisfactory solution to the oscillation problem it will earn the gratitude of all listeners

○○○○

**That £620,000.**

It was stated by the Postmaster-General in the House of Commons on October 26th that he was not aware that there was any general feeling that the amount of £620,000 allocated to the B.B.C. for the period from April 1st to December 31st, 1926, to cover programme and liquidation expenses was inadequate.

In view of the statement frequently made that the income of the B.B.C. has been limited by the Post Office to £500,000 there may be some misapprehension about the amount actually spent by the company on programmes. I am told that out of this £620,000, about £125,000 will be spent on liquidation, and probably another £100,000 will be incurred in the discharge of other liabilities. The amount actually available for the service is therefore round about £390,000.

○○○○

**Why Artists are Under-paid.**

This helps to explain, perhaps, why the B.B.C. has recently been involved in controversies respecting payments to artists.

It is to be hoped that the whole question of the disposal of listeners' money will be carefully sifted when the corporation enters upon its duties. It is something of an anomaly, and would be comic if it were not serious, that a vast army of licensed listeners must content itself with inferior talent while officialdom sits on "surplus" licence money. There

**FUTURE FEATURES.****Sunday, November 14th.**

LONDON.—Service from St. Martin-in-the-Fields.

BIRMINGHAM.—Birmingham Cathedral Bells and Service.

BOURNEMOUTH.—Symphony Concert.

MANCHESTER.—Four Recitals—Song, Piano, Cello and Clarinet.

GLASGOW.—An afternoon of Chamber Music.

ABERDEEN.—Annual Church Parade of Boys' Brigade.

**Monday, November 15th.**

LONDON.—"Penella," an opera in one act.

CARDIFF.—Famous Airs and Ballads.

MANCHESTER.—Celebration of Station's Fourth Anniversary.

NEWCASTLE.—Vincent Caygill (pianoforte) and Symphony Orchestra.

BELFAST.—Ministry of Labour Choral Society.

**Tuesday, November 16th.**

LONDON.—Song Recital.

BIRMINGHAM.—"The Blue Penguin," played by London Radio Repertory Players.

CARDIFF.—"Dick's Sister," Duologue by Norman McKinnel.

MANCHESTER.—Irwell Springs (Bacup) Band.

NEWCASTLE.—Short Recital by Mavis Bennett (soprano).

**Wednesday, November 17th.**

LONDON.—Act 2 of "Tannhauser" relayed from Manchester.

MANCHESTER.—The Edith Robinson Quartet.

**Thursday, November 18th.**

LONDON.—Light Symphony Concert.

CARDIFF.—Programme in honour of famous Welsh sailors.

MANCHESTER.—"The Partners," by Vincent Douglas.

**Friday, November 19th.**

LONDON.—Ballad Concert: "The House Agent," by Gerald Grace.

BIRMINGHAM.—d'Erlanger Programme.

BOURNEMOUTH.—Military Band Night.

CARDIFF.—"Best Sellers," No. 1.

MANCHESTER.—"Contrasts"—Works by two composers.

GLASGOW.—Light Orchestral Concert.

ABERDEEN.—Scottish Programme.

**Saturday, November 20th.**

LONDON.—"Daily Express" Concert.

BIRMINGHAM.—Popular Programme.

CARDIFF.—"November Night-Lights."

MANCHESTER.—West Country Songs.

NEWCASTLE.—Band Concert.

should be no surplus while listeners are unprovided with alternative programmes.

○○○○

**The Programme Sleuth.**

One of the least pleasant jobs, I imagine, must be that of the programme sleuth, whose business is to steal out into the highways and by-ways for the purpose of securing inexpensive broadcasting talent. Yes, my friends; Savoy Hill has its heroes.

One day, perhaps, tales will be told of grim encounters with recalcitrant theatre managers, of agonising moments at stage doors and palpitating interviews in green rooms . . . but not now.

○○○○

**Russian Tactics.**

In Russia the job of programme sleuth must be a genuine sinecure, judging from the latest news item from Moscow, where a famous woman singer has been prosecuted for "personal egotism" on the grounds that she demanded a fee for broadcasting.

The Russian programme sleuth must have the easiest job in the world.

*Programme Sleuth* (to famous tenor): Superb!

*Famous Tenor* (gratified): Ah, you like my singing?

*P.S.*: It is grandski. You must pour your voice over Russia.

*F.T.*: You are too kind; but how much do you pay?

*P.S.*: Inspector, give me those hand-cuffs!

(*F.T.* collapses on top note.)

○○○○

**Daventry and Birmingham Partnership.**

Daventry will on November 19 relay a programme from Birmingham, in which Mr. Percy Pitt, the Director of Music to the B.B.C. will conduct the station orchestra through a selection from the works of d'Erlanger.

○○○○

**Programme by Blind Artists.**

St. Cecilia is the patron saint of the blind, and on November 22nd, which is her name day, a blind programme, arranged by Captain Ian Fraser, M.P., will be broadcast from 2LO. The programme will include Sinclair Logan (baritone), Ronald Gourley (pianist), and other blind artists known to listeners.

○○○○

**Filming, Recording and Broadcasting!**

Community singing by the audience will be relayed from the Prince of Wales's Playhouse, Lewisham, on November 12th. A double-sided record will be taken by a gramophone company of the singing of the audience of two thousand, and a film of the event will also be specially made.

○○○○

**Brazen Broadcast.**

A brass band contest, open to the counties of Northumberland, Durham, Cumberland, Westmorland, and including Middlesbrough, will be featured by the Newcastle station on November 20th. The adjudication will be by wireless. The judge will not see the bands, their music being relayed to the studio, where the judge will be accommodated.

# The Wireless World

AND  
RADIO REVIEW  
(14<sup>th</sup> Year of Publication)

No. 377.

WEDNESDAY, NOVEMBER 17TH, 1926.

VOL. XIX. NO. 20.

Assistant Editor:  
F. H. HAYNES.

Editor:  
HUGH S. POCOCK.

Assistant Editor:  
W. JAMES.

Editorial Offices: 139-40, FLEET STREET, LONDON, E.C.4

Telephone: City 4011 (13 lines)

Advertising and Publishing Offices: DORSET HOUSE, TUDOR STREET, LONDON, E.C.4.

Telephone: City 2847 (13 lines)

Telegrams: "Ethaworld, Fleet, London."

COVENTRY: Hertford Street.

BIRMINGHAM: Guildhall Buildings, Navigation Street.

MANCHESTER: 199, Deansgate.

Telegrams: "Cyclot Coventry."  
Telephone: 8210 Coventry.

Telegrams: "Astopress, Birmingham."  
Telephone: 2970 and 2971 Midland.

Telegrams: "1111e, Manchester."  
Telephone: 8970 and 8971 City.

Subscription Rates: Home, 17s. 4d.; Canada, 17s. 4d.; other countries abroad, 19s. 6d. per annum.

As many of the circuits and apparatus described in these pages are covered by patents, readers are advised, before making use of them, to satisfy themselves that they would not be infringing patents.

## A CONDUCTOR'S VIEW ON BROADCASTING.



THE views of Sir Thomas Beecham on broadcasting have recently been given to the world, and, to judge from what we have read of them in the daily Press, they are not we think altogether

complimentary.

We are told that the best music when broadcast "sounds from beginning to end like the gibbering and whining of goblins and devils." Sir Thomas is scarcely fair to the wireless industry unless he discloses the name of the makers of the set on which he has acquired so intimate an acquaintance with broadcast reception. We wonder, too, if any of his friends have since taken him in hand, because his outburst, coming as it did on the eve of National Wireless Week, sounded almost like a challenge.

But is it not distressing that a man like Sir Thomas, who tells us that his life has been devoted to music and to the cause of encouraging a taste for good music in others, should be so unsympathetic, not to say resentful, towards the one method which bids fair to succeed, where he and many others have failed, in creating a national taste for the best music? We can forgive Sir Thomas for his ignorance of the degree of perfection attained in broadcast reception and transmission because he may have been unfortunate in his broadcast experiences, but we cannot easily forget he has made it abundantly clear that if he had his

way the microphone would for ever cease to function as a distributor of music.

Musicians, with but few exceptions, are to-day accepting broadcast reproduction as a very close approximation to the original performances before the microphone, and broadcasting is blessed by them, since it provides the means of bringing good music to the ears of many thousands of persons who, without it, would seldom, if ever, have the opportunity of hearing the best musical performances. Every week that broadcasting continues the public taste for good music is extended, and by no other means could it have been possible to stimulate so wide an interest as has been done by the aid of the microphone.

The principal objection of Sir Thomas to broadcasting seems to depend upon the fact that broadcasting is a mechanical invention. We might, in turn, remind him that every musical instrument in an orchestra which he conducts must be included in the same category, and yet he has no hesitation in accepting orchestral instruments as legitimate musical reproducers.

Sir Thomas is leaving us for the more hospitable shores of America, and in bidding England farewell he tells us that though to-day his genius is without honour in England, yet he anticipates that when he returns to this country "too feeble to be of any use, and no longer fit to conduct, he may receive a rousing welcome." If and when this prophecy comes true, will Sir Thomas take credit to himself for the welcome, or will he recognise that broadcasting will have made that welcome possible by creating for him an appreciative audience?

### CONTENTS.

	PAGE
EDITORIAL VIEWS	661
SIMPLE WAVEMETER FOR BROADCAST LISTENERS	662
By W. James.	
THE PARIS RADIO SHOW	665
VALVES WE HAVE TESTED: THE MULLARD "PM" SERIES	667
PRACTICAL HINTS AND TIPS	669
CURRENT TOPICS	671
THE RADIO SHIP TELEGRAPH I (continued)	673
By A. P. Castellain.	
IDENTIFYING FOREIGN TRANSMISSIONS	675
By C. F. Carr.	
PIONEERS OF WIRELESS—35	677
By Ellison Hawks.	
SUPERSONIC TRANSFORMERS—Part II	680
By N. W. McLachlan.	
BROADCAST BREVITIES	685
EVERYMAN'S THREE-VALVE RECEIVER (concluded)	687
By W. James.	
LETTERS TO THE EDITOR	689
READERS' PROBLEMS	691

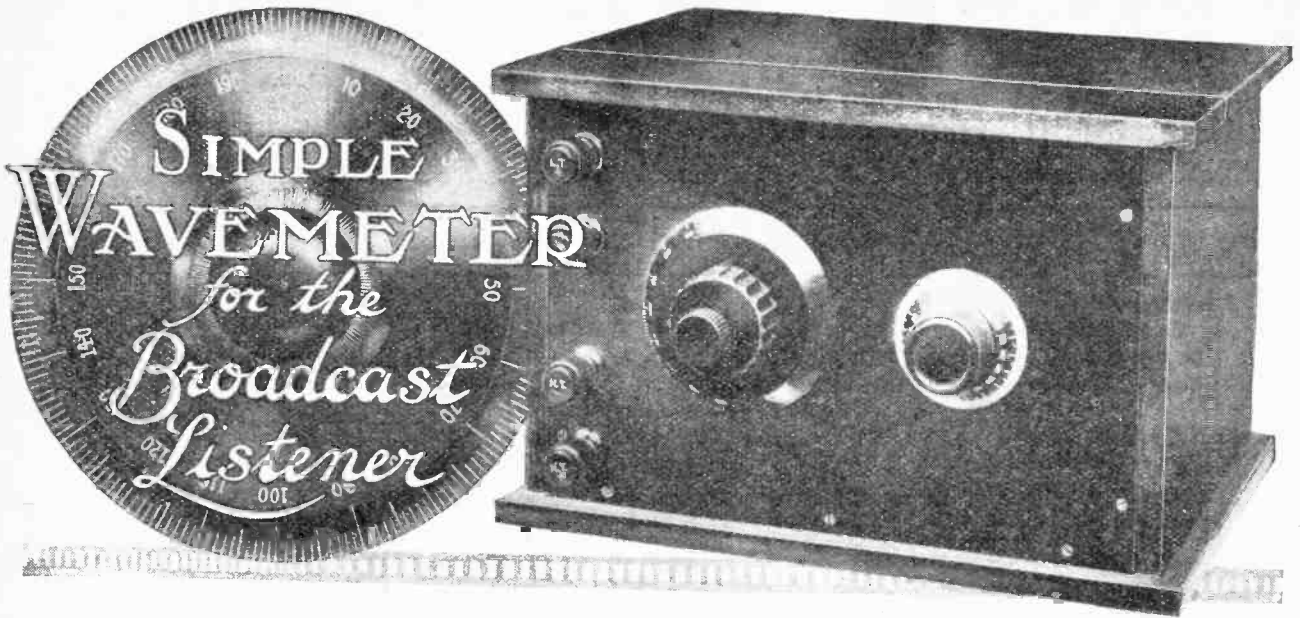

### Description of a Cheap and Reliable Instrument.

By W. JAMES.

ONE of the most valuable instruments which an experimenter can possess is a valve wavemeter. Quite apart from its value in experimental work, such as when measuring the capacity and inductance of condensers and coils, a wavemeter is of great assistance when tuning a receiver. Modern receivers including tuned radio-frequency amplification are generally so selective that a good deal of time can be saved by tuning the circuits to a wavemeter sending waves of a known frequency.

It is not necessary to stress the advantages of being able to calibrate a receiver; those who take an interest in the foreign broadcast stations find a wavemeter a quick means of identifying those stations which work on their published wavelength. Now that so many stations have changed their wavelength it becomes necessary to recalibrate our receivers, and this is most easily accomplished by means of an accurate wavemeter. On many receivers tuning condensers of the correct square law type are fitted, so that an

approximate calibration is obtained by noting the dial reading of two or three stations of known wavelength and assuming that a linear relation holds between dial setting and wavelength, except at the extreme ends of the dial.

A wavemeter is such a simple and inexpensive piece of apparatus, however, and is so valuable an aid to tuning,

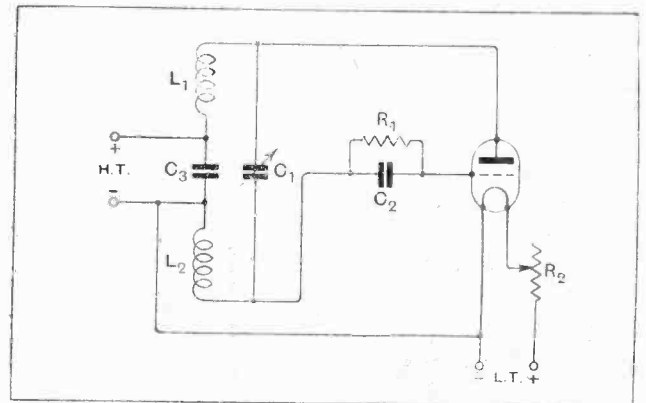

Fig. 2.—A second method of connecting a wavemeter.  $L_1$ ,  $L_2$ , Dimic coil 200  $\mu$ H.;  $C_1$ , 0.0005mfd.;  $C_2$ , 0.002mfd.;  $C_3$ , 0.01mfd.;  $R_1$ , 0.5 megohm;  $R_2$ , filament rheostat.

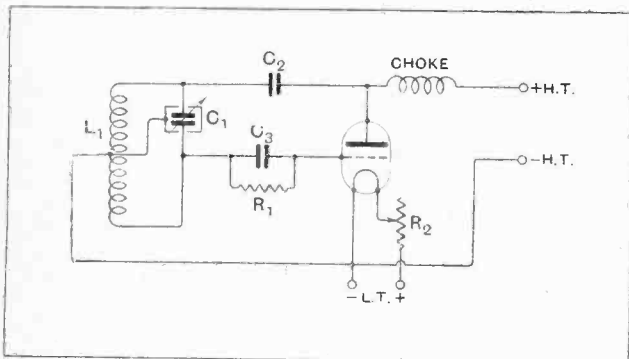

Fig. 1.—Theoretical connections of wavemeter.  $L_1$ , Dimic coil 200  $\mu$ H.;  $C_1$ , 0.0005mfd.;  $C_2$ , 0.00005 to 0.0001mfd.;  $C_3$ , 0.002mfd.;  $R_1$ , 0.5 megohm;  $R_2$ , filament rheostat.

that it is worth while to make one. A few weeks ago Mr. Colebrook described the circuit of the wavemeter,<sup>1</sup> and mentioned various points of interest. The instrument illustrated here has a similar circuit to the one described, and was built with the idea of accuracy, robustness, and reproducibility. The two most important parts of a wavemeter are the tuning condenser and tuning coil. In the arrangement of Fig. 1 the tuning condenser,  $C_1$ , is shown connected across the outer ends of the tuning coil  $L_1$ , and

<sup>1</sup> October 6th, 1926, page 481.



**Simple Wavemeter for Broadcast Listener.**— this is the circuit which determines the wavelength. Of course, the apparatus connected to the tuned circuit, which includes the valve and its holder, the grid condenser and leak ( $C_3, R_1$ ) and the anode stopping condenser ( $C_2$ ), affect the wavelength to which the circuit will tune, but these items should be so arranged that their effect is a permanent one and not likely to vary over a period of use.

**The Tuning Coil and Condenser.**

It is, therefore, of first importance to use a thoroughly reliable tuning coil and condenser. A "Dimic" coil, which has its winding split at the centre, was chosen for the tuning inductance, and a "Pye" 0.0005 mfd. condenser for the tuning condenser because it is provided with end plates which can be earthed and has a slow motion movement.

When the end plates are connected to - L.T. the moving and fixed plate of the condenser are screened, and hand effects are absent. This is an important point, because both sets of plates are at a high-frequency potential with respect to the filament when the wavemeter is working. Stopping condenser  $C_2$ , which has a capacity of 0.00005 to 0.0001 mfd., stops the flow of direct current from the anode battery through the tuning coil, whilst the high frequency choke coil limits the flow of high frequency current through the anode battery.

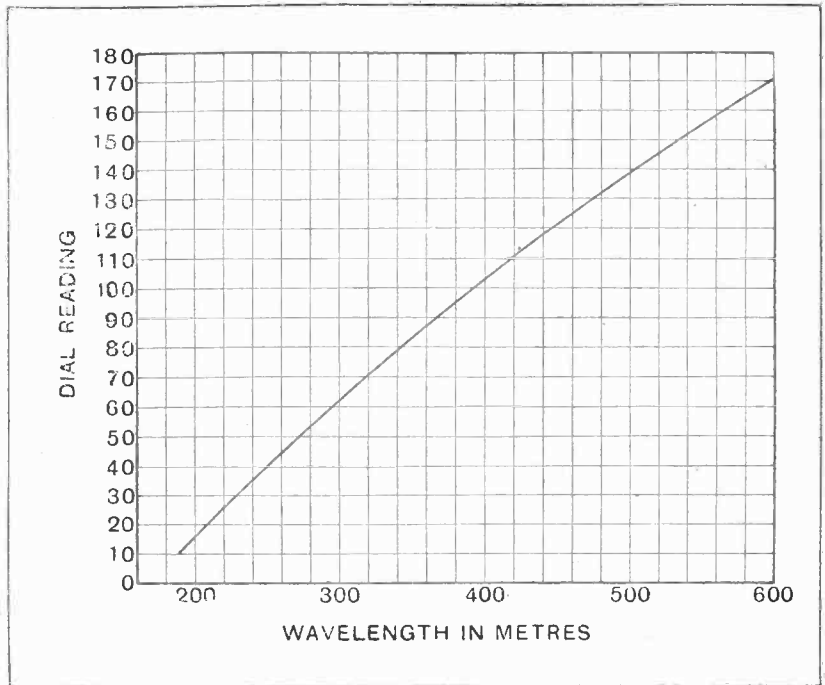
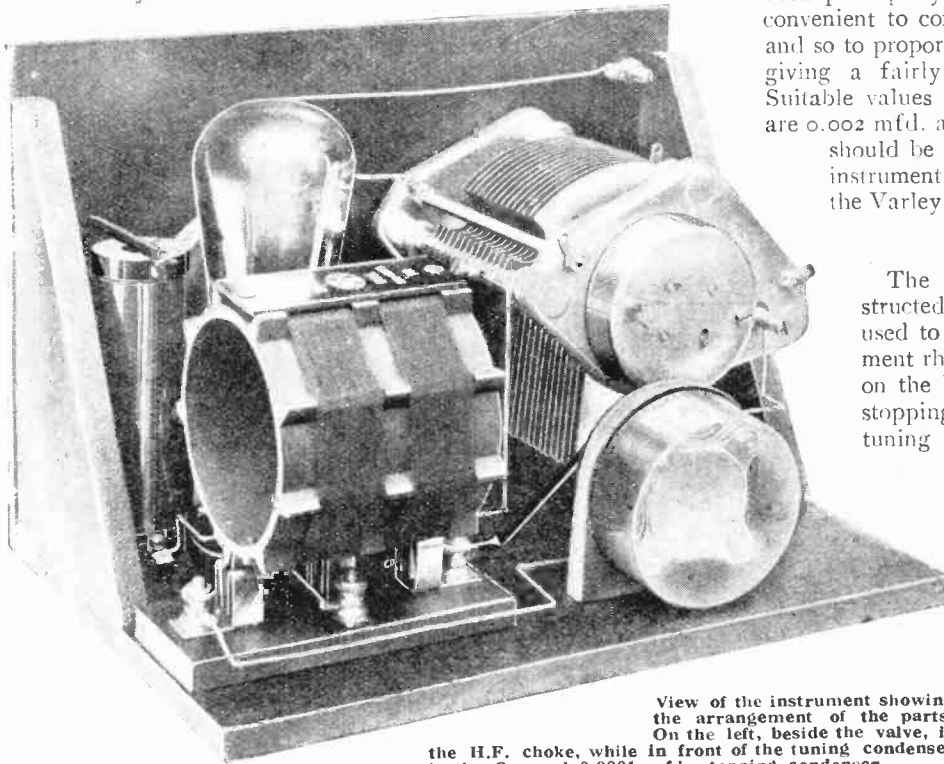

Fig. 3.—Wavelength range of the instrument.

If this apparatus is connected according to Fig. 1, the grid condenser and leak  $C_3, R_1$ , being omitted, continuous waves are generated and would be heard in a receiver fitted with reaction. The instrument in this form would have a variety of uses, but when it is to be used principally as an aid to rapid tuning it is convenient to connect a grid condenser and leak and so to proportion them that a modulated wave giving a fairly high pitched note is emitted. Suitable values for the grid condenser and leak are 0.002 mfd. and 0.5 megohm. The choke coil should be a good one; the one used in the instrument illustrated was manufactured by the Varley Magnet Co.

**Construction.**

The instrument is very easily constructed; an ebonite panel, 9in. x 6in., is used to carry the tuning condenser, filament rheostat and battery terminals, and on the baseboard attached to this is the stopping condenser  $C_2$ , valve-holder, tuning coil, high-frequency choke, and the grid condenser and leak. The valve-holder is mounted just behind the filament rheostat. To the right of this is the high-frequency choke coil and at the back of the baseboard will be seen the "Dimic" coil. The cabinet is a home-made one, and was made from a set of parts supplied by Messrs. Hobbies, Ltd.



View of the instrument showing the arrangement of the parts. On the left, beside the valve, is the H.F. choke, while in front of the tuning condenser is the Ormond 0.0001 mfd. stopping condenser.

**Simple Wavemeter for the Broadcast Listener.—**

When wiring, care should be taken that the wires are run in positions where they are not likely to move, and it is advisable to cover some of them with Systoflex.

The wavelength range of the instrument is from about 600 to 190 metres, and a high pitched note is heard in a receiver tuned to the wavemeter.

Strong oscillations are produced when an anode battery of 24 volts is used with almost any type of 2-volt valve. The valve may be of the H.F. or L.F. type, and be one with a low filament consumption.

When using a 2-volt valve such as the "Cossor Point One" it was found that adjustment of the filament rheostat did not produce a measurable change in the wavelength and small variations in the voltage of the H.T. battery did not produce a noticeable effect. The accompanying curve shows the wavelength range, and will be fairly accurate when the same type of tuning coil and condenser are used. There are almost bound to be slight changes in the wavelength for various settings between different instruments, because the tuning condensers will probably not be identical, and neither will the wiring, but those who cannot have the wavemeter properly calibrated will find the curve a useful guide, as it will probably be accurate to within a few metres.

**Other Uses.**

The wavemeter can be used for the generation of short waves by putting in an appropriate coil, but it is advisable to mark the coils so that they are in connected circuit in the same direction.

For use in connection with short wave transmitters it is advisable to connect a pair of phones in series with the anode circuit, the phones being joined between the high-frequency choke coil and the positive terminal of the H.T. battery. They should be shunted by an 0.001 mfd. condenser, and the grid condenser and leak should also be short-circuited. The wave-

meter is then a simple oscillator, and may be used for a variety of purposes.

In Fig. 2 is given the connections of another form of oscillator which some may prefer to that already described. It will be seen that the two outer ends of the "Dimic" coil,  $L_1$   $L_2$ , are connected across the tuning condenser  $C_1$ , while the two inner ends are connected by a condenser  $C_2$  of about 0.01 mfd. In this circuit the tuning condenser has to withstand the full voltage of the anode battery and the coupling of anode and grid circuits is fixed,

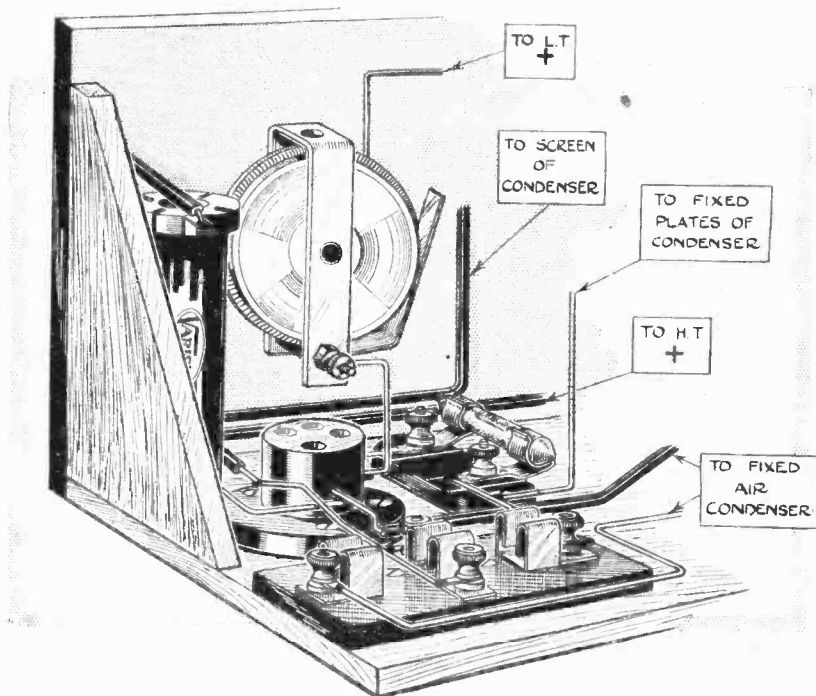

Fig. 4.—Arrangement of the parts of the wavemeter.

but apart from this it is a very good circuit, and in some respects is preferable to that of Fig. 1.

It can be constructed in a similar manner to the instrument illustrated, and its wavelength range will be approximately the same.

We give below a list of those who are willing to forward QSL cards to amateur transmitters in their respective countries. As, however, the work is in many cases undertaken by amateurs and involves considerable trouble and often no little expense for postage, we would ask all those who wish to send QSL cards to use every endeavour to ascertain the QRA of the foreign transmitter before troubling the distributing agent and to be sure that their cards are sufficiently stamped.

**Argentina** "Radio Revista," Lavelle 1268, Buenos Aires.  
**Australia** "Radio," Williamson House, 51, Castlereagh Street, Sydney.  
**Austria** G. E. Roth c/o "Radiowelt," Rüdengasse 16, Vienna.  
**Belgium** Reseau Belge, 11, Rue du Congrès, Brussels.  
**Bermuda** W. F. Hoisington, Paget West, Hamilton.  
**Brazil** Vasco Abreu, 89, rue Riachuelo, c/IV, Rio de Janeiro (BZ 1AW).  
**Czecho-Slovakia** N. Schaferling, Sumavska 12, Prague XII.

### Voluntary Distributors for Overseas QSL Cards.

**Chile** L. M. Desmaras, Casilla 59D, Santiago (CH 2LD).  
**Denmark** J. Steffensen, Ehlersvej 8, Hellerup, near Copenhagen (D 7JS).  
**Finland** K. S. Saino, Merik 3A, Helsinki 10 (S 2NAI).  
**France** "Journal des Emetteurs," 53, Rue Réaumur, Paris 2.  
**Germany** Herrn Kruschwitz, Funkverein, Reilstrasse 128, Halle-an-Saale (K LI).  
**Holland** R. Tappenbeck, Hoogdiltun, Noodwijk-aan-Zee.  
**India** R. J. Drudge-Coats, Cambridge Barracks, Rawalpindi.  
**Italy** F. Pugliese, Via Borgonovo 21, Milan (I 1EP).

**Latvia** Dr. Walter, Brivbasia 107, Riga.  
**Luxembourg** J. Wolff, 67, Avenue du Bois, Luxembourg (L 1JW).  
**Malay States** J. P. C. Bell, F.M.S. Railways, Kuala Lumpur, Kelangor, Federated Malay States.  
**New Zealand** F. D. Bell, Waihemo, Palmerston, Otago (Z 4AA).  
**Norway** J. Diesen, Moen i Maalselv, Tromsø (LA 1A).  
**Philippine Islands** Lieut. H. P. Roberts, Singal Corps, Fort McKinley, Rizal (P 1HR).  
**Poland** "Radiofon Polski," ul Wilcza 30, Warsaw.  
**Porto Rico** J. Agusti, 25, Pershing Avenue, San Juan (PR 4JE).  
**Portugal** E. de Avillez, Costa de Castello 13, Lisbon (P 1AE).  
**Russia** W. Petroff, Novaia 40, Nijni Novgorod (R 1FI).  
**South Africa** H. W. Haywood, 91, Berea Park Road, Durban (O ABE).  
**Spain** Miguel Moya, Megia Lequerica 4, Madrid (EAR 1).  
**Sweden** Bruno Rolf, Hamngatan 1A, Stockholm.  
**Switzerland** Dr. W. Merz, Berne-Bunplitz.  
**U.S.A.** The Traffic Manager, A.R.R.L., 1045, Main Street, Hartford, Conn.  
**Yugo-Slavia** M. Torbarina, Dubrovnik 2, Gruz (YS 1XX).

# THE PARIS RADIO SHOW

Single-control Broadcast Receivers—Cone Diaphragm Loud-speakers—Frame Aerial Sets.

WITH the winter months and the influx of the "monde" to Paris comes one of the events in wireless which may well be rated as of special importance throughout southern Europe—the radio exhibition at the Grand Palais, on the Avenue des Champs Elysées. The first year this exhibition took place (1923) a combination was made with the industrial and laboratory physicists of France, and the building was a labyrinth of scientific innovations, mysterious flashes, roars, clicks, and hoarse loud speakers.

This year, while the exclusion of the physics section has left a more peaceful atmosphere, and only the purer tones of the modern loud-speakers are evident, another combination has been effected, in which the overflow of the automobile industry—principally the commercial vehicle phase—has been given the ground floor, while the lighter radio instruments have taken over the entire balcony.

As one approaches the building it is evident that the wireless show is in full swing, for the giant Gaumont loud-speakers on the roof blare forth music or bellow announcements at the passers-by. The noise is such that often on starting from the Place de la Concorde one can hear the music distinctly, and the announcements can be followed for several hundred feet on either side of the building.

Once inside the building and up the balcony stairs, the first stand that catches the eye of the scientifically inclined amateur is that of the radio lighthouse group, set up by the French Government to show the method of fog signaling now being adopted along their coast-line.

### Marine Wireless.

A coast lightship equipment, including the power plant, is assembled on the stand and is attracting a large amount of interest from the city dwellers, who have not yet clearly realised this phase of wireless. The principle is the same as any continuous wave station, and can be detected for some twenty miles from the coast in all directions.

Among the larger manufacturers who have stands near the main staircase is the S.F.R. "Radiola" group—the

receiving set manufacturers of the Société Française Radioélectrique, one of the largest radio companies in this part of Europe and equivalent, in a way, to the Radio Corporation of America, in New York. While novelties are not in unusual evidence, there are several minor improvements to be seen. France has definitely followed the other countries into the realm of decorative art as applied to radio. But the French have turned to the modernist line of cabinet and loud-speaker rather than to the conventional lines of the past. The results are perhaps, to the Anglo-Saxon, a trifle bizarre, but properly set, the rounded frames, the octagonal and fan-shaped loud-speaker horns, and the highly polished combination wood panels are in most part attractive to the eye, and probably enjoy a far greater popularity among the general public than do the old-fashioned exposed sets of the first "hams."

### New Loud-speakers.

There is the new "Radiola" loud-speaker of the diffuser or diaphragm type, with a specially treated cone

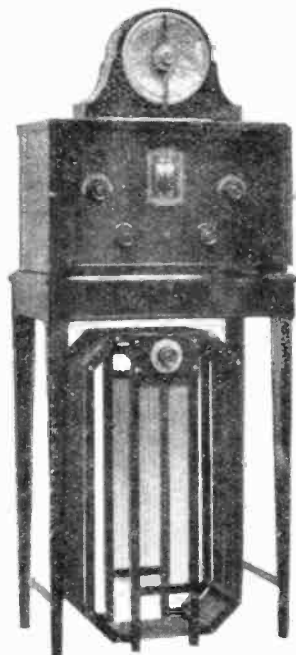
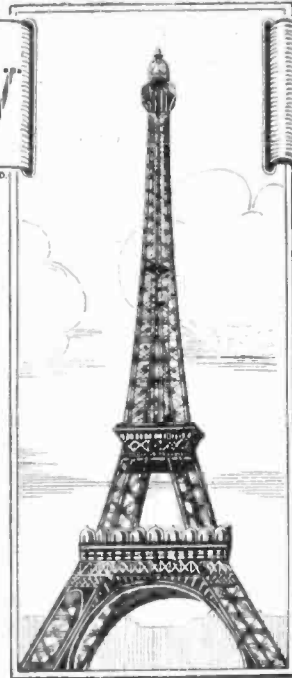

Radiola single control receiver with double-frame aerial and clock-type loud-speaker.



A striking display on the Radiola stand. The receiving set in the foreground takes programmes from stations indicated by arrows on the map behind. The station actually being received at any time is illuminated from behind on the map.

**Paris Radio Show.**

—smaller than their original diffuser, but of a higher tonal purity and more decorative in appearance. The paper appears almost like an imitation tortoise-shell or smoky celluloid, and one of the directors told me that they are selling an average of 500 per day for distribution in France alone.

The French have turned with enthusiasm to the single control set for reception, and there are many different models among those on display. "Radiola" exhibit a dual control set that gives the impression of single control, as the two condensers are on one vernier, and, having once been set on a certain wave, can be adjusted together. "Radio LL," which is the house of Lucien Levy, famous for his heterodyne patents and also for his proposed radio "death ray," is showing an automatic control set—the "Syncrodyne," in which the various stations to which this set can listen are numbered, and the tuning done merely by turning the dial to the number desired.

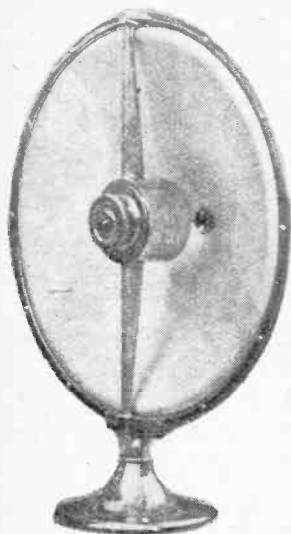

The Radiola diffuser or diaphragm type loud-speaker.

**Frame Aerials.**

The built-in aerial is appearing throughout; or, if a frame is used outside, is generally camouflaged by a covering of chintz or other material with attractive designs. There are many multi-valve sets in evidence, as the French are showing a great interest in the British, German, Spanish, and even the Russian stations. This would appear to be more from the standpoint of variety than from the more American interest in distance reception. The French are inclined to be critical of their

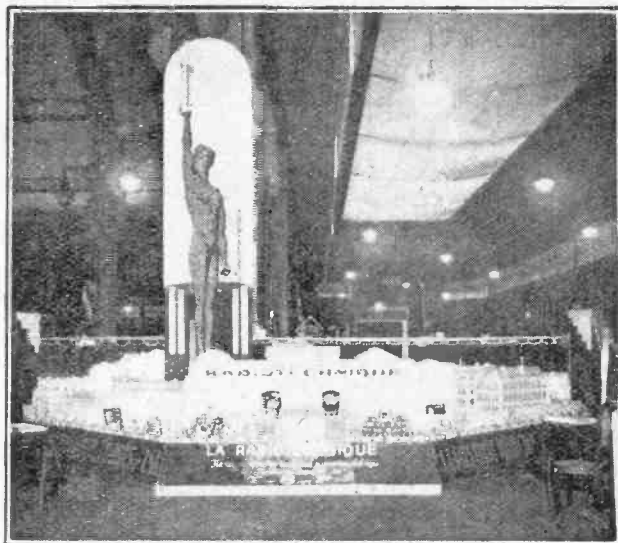

Stand of Cie Radiotechnique, one of the foremost French valve manufacturers.

own programmes, which they regard as mediocre, and are therefore anxious to sample those of other countries.

**Loud-speakers.**

Among the loud-speakers, the diffuser or diaphragm type is more popular than ever, and many variations of this are to be seen. "Radiola" is now putting out, beside the special type mentioned above (which, incidentally, is surprisingly similar to the popular Saldana type), a fluted diffuser with the magnets in front of the diaphragm. Another style to be seen is a sort of cockle-shell, the magnetic parts being out of centre, and the fluting leading down to this in the form of a fan. The Saldana loud-speaker has attracted great attention, including special notice from President Doumergue, during his visit.

The French are giving some attention this year to wavemeters and "instruments of precision," as they are termed here. The Precision Electrique Company are putting out some especially attractive meters, carefully calibrated.

Among the more conspicuous novelties is a new method of calibrated frame aerial, in which the antenna coil readings are set upon a dial which covers the entire frame, the wavelength of each station being indicated, and a large indicating pointer passing over these, as in a tuning condenser. More practical still is the manner in which the aerial is set over a large map of Europe, laid flat as a sort of table.



Commercial and marine transmitting and receiving apparatus exhibited by the S.F.R.

**Paris Radio Show.**

On this map are indicated the directions of the various principal broadcasting stations of Europe, so that once set the map serves as a radio compass, and, by turning an indicating needle on the frame shaft to the station desired, the best reception is assured.

A battery of some interest is the Koda, which consists of a series of permeable cells filled with special material, even the electrodes being inserted in these sac cells. Thus a sort of semi-storage battery is created, electrolytic material being poured into the battery, and the charge renewed whenever the material is dried out.

Among the general accessories, one that appeared to be particularly practical was a small electromagnetic coil, the "Fakir," which could be hooked up to any lighting circuit, and, by the pushing of a button, would either magnetise or demagnetise any metal instruments immediately, according to the needs of the user and to whether A.C. or D.C. mains were used. For instance, with A.C. a screwdriver, which might have become magnetised in working on a set, can be thrust through the centre of this little ring-like coil, and comes out free. The contact is instantaneous. The demonstrator had a steel file, with which he would pick up filings and then drop them by passing through the "Fakir." It is manufac-

tured and sold by the Etablissements Dargent, 32, Rue de la Chapelle, Paris.

The usual scientific apparatus was present, stands being prominent with the Belin teleautograph, the Jouaust photoelectric cell work (light audibility), etc. M. Belin is now working on his television (or at least his factory is working on it, while he is in China on some special work), and his assistants say that it is merely a matter of mounting the final commercial apparatus to have this a finished product. One or two other interesting transmissions of this sort are also being developed.

The popularity of the four-electrode or bi-grille valve for reception seems to continue undiminished. The amateurs with whom I have talked are enthusiastic about its qualities, and it is very well displayed at the stand of the Radiotechnique Co., a subsidiary company of the S.F.R. As a whole, the wireless exhibition shows some definite progress in France during the last year, and promises a prosperous season, in spite of the sunspot static trouble, etc. The stands as a whole are well set up, and the crowded condition of the Grand Palais balcony every afternoon shows that the question of over-supplying the market in France is not yet one of serious portent. Prices are, if anything, lower, and there are many new firms appearing in the field.

**VALVES WE HAVE TESTED**

**THE MULLARD "PM" SERIES.**

THE Mullard range includes valves having 2, 4 and 6 volt filaments, and in each class a valve is provided for high-frequency amplification and detection, and for low-frequency amplification or the output stage. These valves are of the coated filament type. They provide an exceptionally large electron emission for a small heating current, and when heated by the normal filament current only a faint glow is discernible.

Specimen valves were obtained and tested, with the results given below. It will be seen that in the two-volt range are three types of valve, the PM 1 L.F., PM 1 H.F., and PM 2. The latter valve is suitable for the output stage of a low-frequency amplifier because it has a low A.C. resistance and can be worked with a grid bias of at least negative 9 volts with an anode voltage of 100. Used with these voltages, the anode current is only 4.7 milliamperes, and reasonably strong loud-speaker reception can be had without overloading.

**Type PM 1 L.F.**

Filament voltage 1.8. Anode voltage 50-100. Filament current 0.1 ampere. Total emission 8 milliamperes.

Anode Voltage. Volts.	Anode Current. Milliamperes.	Grid Bias. Volts.	A.C. Resistance. Ohms.	Amplification Factor.
50	1.1	-1.5	27,000	8.6
70	1.7	-3.0	23,000	8.4
100	2.3	-4.5	19,500	8.3

**Type PM2.**

Filament voltage 1.8. Anode voltage 50-100. Filament current 0.15 ampere. Total emission 20 milliamperes.

Anode Voltage. Volts.	Anode Current. Milliamperes.	Grid Bias. Volts.	A.C. Resistance. Ohms.	Amplification Factor.
50	2.65	-3.0	9,250	5.6
80	4.35	-6.0	8,650	5.4
100	4.7	-9.0	8,000	5.0

**Type PM 1 H.F.**

Filament voltage 1.8. Anode voltage 50-100. Filament current 0.1 ampere. Total emission 8 milliamperes.

Anode Voltage. Volts.	Anode Current. Milliamperes.	Grid Bias. Volts.	A.C. Resistance. Ohms.	Amplification Factor.
50	0.59	-0.5	29,000	17.2
70	0.89	-1.0	31,600	15.4
100	1.68	-1.5	28,800	14.3

The PM 1 L.F. and H.F. valves differ in their A.C. resistance and amplification factors, the L.F. valve having lower values in each instance. Under the conditions of the tests the H.F. valve appears to be much the better valve of the two, in that its amplification factor is higher than that of the L.F. valve, in spite of the fact that the A.C. resistances are not very different.

These valves (the PM 1 H.F., L.F. and PM 2) are



**Valves We Have Tested.—**

designed to be heated from a two-volt accumulator and a filament resistance of about 7 ohms should be used in order to obtain the longest life.

**Type PM3.**

Filament voltage 3.7. Anode voltage 50-100. Filament current 0.11 ampere. Total emission 40 milliamperes.

Anode Voltage. Volts.	Anode Current. Milliamperes.	Grid Bias. Volts.	A.C. Resistance. Ohms.	Amplification Factor.
50	0.7	-0.5	25,000	13.3
75	1.2	-1.5	21,600	14.4
100	1.4	-3.0	19,000	13.8

**Type PM4.**

Filament voltage 3.7. Anode voltage 50-100. Filament current 0.11 ampere. Total emission 40 milliamperes.

Anode Voltage. Volts.	Anode Current. Milliamperes.	Grid Bias. Volts.	A.C. Resistance. Ohms.	Amplification Factor.
50	2.2	-1.5	11,500	6.8
75	4.0	-3.0	9,300	6.8
100	5.8	-4.5	8,700	6.5

In the series designed for working from a 4-volt accumulator are three types, the PM 3, PM 4 and DP 425. The PM 3 valve has an amplification factor of 13 to 14 and an A.C. resistance of 19,000 to 25,000 ohms. This valve is, therefore, suitable for use in resistance- or choke-coupled amplifiers, as a detector, and as a high-frequency amplifier, provided the coupling transformer is of suitable design. This valve should not be used in the output

**Type DP 425.**

Filament voltage 3.8. Anode voltage 50-100. Filament current 0.25 ampere. Total emission over 50 milliamperes.

Anode Voltage. Volts.	Anode Current. Milliamperes.	Grid Bias. Volts.	A.C. Resistance. Ohms.	Amplification Factor.
50	4.6	-4.6	4,170	3.8
70	6.2	-9.0	3,540	3.7
100	10.9	-12.0	2,940	3.5
125	12.6	-17.0	3,280	3.72
160	15.4	-22.0	3,160	3.5

stage of a receiver unless the signals are of telephone strength only.

For good loud-speaker work it is essential to use a power valve such as the DP 425, whose A.C. resistance is 3,000 to 4,000 ohms and amplification factor 3.5 to 3.8. This valve is capable of dealing with really strong signals without distortion.

Type PM 4 can be used in the output stage when a small loud-speaker is used, and it is also useful for transformer coupled stages.

**Type PM5.**

Filament voltage 5.5. Anode voltage 50-125. Filament current 0.11 ampere. Total emission 50 milliamperes.

Anode Voltage. Volts.	Anode Current. Milliamperes.	Grid Bias. Volts.	A.C. Resistance. Ohms.	Amplification Factor.
50	0.7	0	35,000	16.9
75	1.0	-1.0	33,000	16.9
100	1.55	-1.5	31,500	16.5
125	2.45	-2.0	27,500	16.3

Two valves of the six-volt type were tested, the PM 5 and PM 6. Type PM 5 has an A.C. resistance of 28,000 to 35,000 ohms and an amplification factor of about 16.5. This valve is therefore suitable for resistance- or choke-coupled amplifiers, and in H.F. and L.F. transformer

**Type PM6.**

Filament voltage 5.5. Anode voltage 50-100. Filament current 0.11 ampere. Total emission 50 milliamperes.

Anode Voltage. Volts.	Anode Current. Milliamperes.	Grid Bias. Volts.	A.C. Resistance. Ohms.	Amplification Factor.
50	2.2	-1.5	10,500	6.8
75	4.1	-3.0	8,300	6.6
100	6.2	-4.5	6,900	6.5

coupled stages where the transformers are of suitable design. It should not be used in the output stage of a low-frequency amplifier. The valve to be used in this position is the PM 6, which will deal with signal amplitudes sufficient for most domestic loud-speakers.

**Weybridge.**

Australia :—A VKP, 2BB, 2BK, 2CG, 2CM, 2CS, 2LJ, 2LK, 2LM, 2NO, 2TM, 2TO, 2YI, 3BA, 3BD, 3BM, 3BQ, 3EF, 3EN, 3KB, 3WM, 3XO, 4AN, 4BD, 4RB, 5BG, 5KN, 6AG, 7CW, 7LA, 7RS. New Zealand :—Z 1AO, 1AX, 1XA, 2AC, 2AE, 2BG, 2BX, 2DY, 2GC, 2XA, 3AG, 3AI, 3AJ, 3AK, 3AR, 3XB, 4AA, 4AC, 4AK, 4AM, 4AO, 4AQ, 4AR, 4AS, 4AV. Various :—FC 8FLO, CB F2, VOQ WNP, TJ CRJ, PI 1AU, PI 1CW, PI 1HR, NADJ, NEQG, NUNN, GLKY GEFT.

(0-v-1 Schnell) 30 to 50 metres.

L. C. Snowden.

**Norresundby, Denmark.**

U.S.A. :—U 1AAO, 1AOR, 1AHV, 1AOS, 1AJ, 1AY, 1DA, 1DLF, 1UC, 1CH, 1KW, 1CIB, 1CMQ, 1AK, 1RB, 1KK, 1CTP, 1AWE, 1CMX, 1AFF, 1RVE, 2AWF, 2AJ, 2KA, 2CK, 2BNJ, 2CVJ, 2MT, 2AGQ, 2UK, 2CKC, 2NO, 2APV, 2BFT, 3BW, 3CJN, 3PF, 3MV, 3BQZ.

**Calls Heard.  
Extracts from Readers' Logs.**

3PF, 4IZ. Brazil :—BZ 1A, 1AB, 1BD, 1AN, 1IA, 1IB, 1BH, 1AP, 1AW, 1AO, 1AQ, 1AD, 1AR, 1BI, 1AV, 1AJ, 1AM, 1AI, 1AK, 1AP, 1BG, 1QA, 2AM, 2AB, 2OO, 5AB. Argentine :—R GA2, CB8. India :—Y 2AK, 1CD, 1CX. Porto Rico :—PR 4JA, 4SA. Various :—C 2BK, CH 9TC, O A6N, R CRL, TJ CRJ. (0-v-1). H. T. Petersen (D 7ZG).

**Greenock.**

(September 15th to October 15th.)

New Zealand :—N 2AC. Brazil :—RZ 1BI, 1AW, 1AM. Porto Rico :—

PR 4SA. Morocco :—FM 1TZ. Finland :—S 2CO. Germany :—K 4GA, W7, I2, W9, 4MFL, J2, L4, 2DO. America :—U 1AAX, 1AJX, 2NAF, KDKA. France :—F 8UT, 8RF, 8JD, 8YOR, 8JL, 8CC, 8JF, 8BA, 8FNG, 8QW, 8GW, 8KMZ, 8KV. Belgium :—B K44, V8, E1, H5, O8, W3. Spain :—EAR6, EAR10, EAR26, EAR19, EAR18, EAR27. Sweden :—SMZN, SMYG, SMTQ, SMVH. Denmark :—D 7BD. Italy :—I 1AX, 1AY, 1GN, 1CO, 1BD, 1AU, 1BA, 1CU. Holland :—N OPM. Yugo-Slavia :—YS 7XX. Russia :—R 1FI, 1NN. Austria :—O W3. Poland :—TP AI. Great Britain :—G 2SZ, 2VJ, 2SR, 2SO, 2NM, 5XO, 5SI, 5WV, 5HA, 5SK, 5AD, 5MS, 5HY, 5WQ, 6WS, 6KK, 6IA, 6YD, 6BR, 6OO, 6QW, 6TX, 6RM, 6CL, 6RD, 6LJ, 6PA, 6VP. Ireland :—GI 6MU, 2IT. Miscellaneous :—SUC, OCNG, RDZO, KTC, KKO, PCRR, PCTT, K 4UAC, PCUU.

(0-v-1 Reinartz) On 20 to 80 metres.

J. Cyril Adams (2BPB).

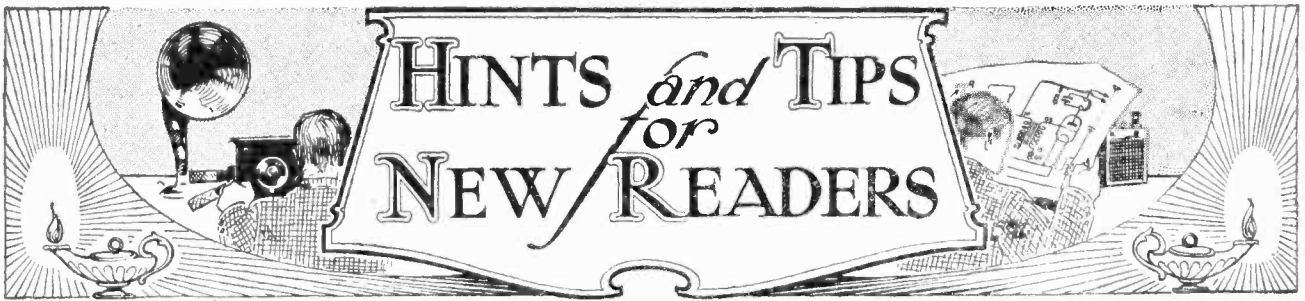

A Section Devoted to the Practical Assistance of the Beginner.

**A SET FOR REMOTE CONTROL.**

The simple receiver discussed in the "Hints and Tips" section last week is particularly suitable when the loud-speaker is to be used in a different room from that in which the apparatus is installed. A schematic circuit diagram showing how it may be modified for this purpose is given in Fig. 1.

The filament circuit may be controlled by a relay with a "trip" or similar action; several different makes are available commercially. These have the advantage that they only consume a momentary current (generally supplied by a small local dry-cell battery of three or four volts) when the set is switched on or off, and do not require a complicated or highly-insulated system of wiring. Provided that the total filament current is reasonably low, as will be the case if the valves are dull emitters, the con-

tacts will operate without giving trouble.

The loud-speaker is joined to the set through a choke-filter output arrangement, with a single wire extension lead and earth return. This has the advantage that the addition of a large capacity across the loud-speaker is avoided. This capacity, with the ordinary method, is of course represented by that of the twin wire which is commonly used.

Everyone who has listened to a loud-speaker operating at a distance from the receiving apparatus will realise the need for some form of control over volume, without the necessity of going to the set. The overall sensitivity which is suitable for, say, the reproduction of an orchestral item, is likely to be insufficient for a less deeply modulated transmission. A certain amount may be done by con-

necting a variable non inductive resistance across the terminals of the loud-speaker itself, but this is, at best, little more than a makeshift, and the arrangement shown in the diagram is distinctly preferable. It will be seen that the rheostat of the "reactor" valve is wired up to the distant point, so that the amount of reaction may be increased by brightening its filament, or entirely done away with by turning the resistance to the "off" position. It will be convenient, if the signal strength is sufficient, to adjust the sensitivity of the set so that a deeply modulated transmission gives comfortable strength without reaction, and to strengthen under-modulated items by adjustment of the rheostat.

It is necessary that the reaction valve should be of a type consuming a low filament current, in order to avoid an excessive voltage drop in the extension leads. If, however, it has a two-volt filament, and is operated from a single accumulator cell, it will almost invariably be found that an extra voltage is required; this may be obtained from a dry battery connected as shown in the diagram. If two-volt valves are used as detector and L.F. amplifier, one of the 0.06 amp. class will be found particularly suitable as a reactor, and a single dry cell will generally supply sufficient extra voltage unless the extension leads are exceptionally long.

If it is inconvenient to provide an earth return for the loud-speaker, this connection may be made through either of the volume control L.T. leads without any bad effects.

When wiring up the extension, the wires to the remote control switch and the rheostat may be twisted into a single four-stranded cable, but the lead for the loud-speaker should be run separately if it is desired to reduce the capacity across that instrument.

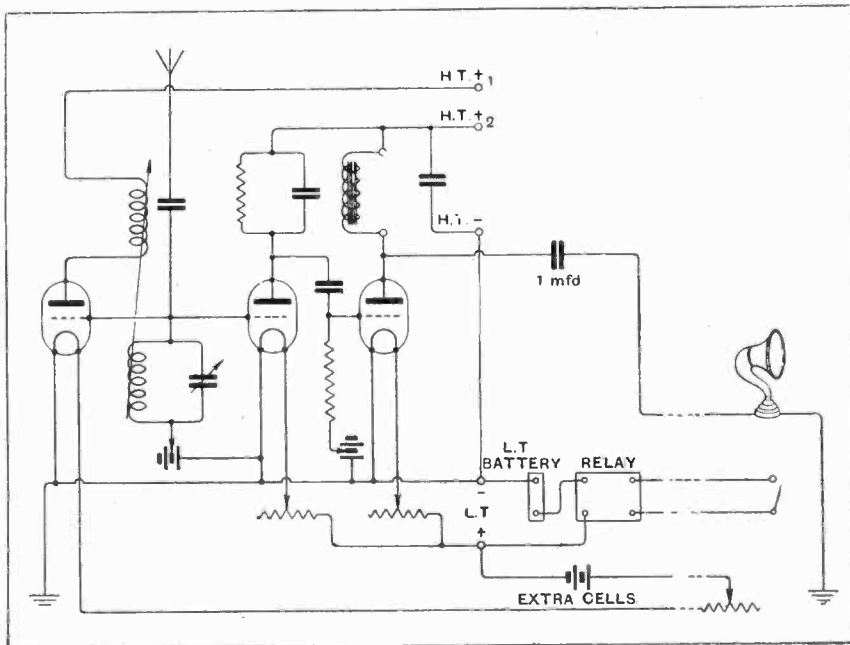

Fig. 1.—Controlling filaments and volume from a distance.

**A FEW "DON'TS."**

Don't forget to test the grid bias battery occasionally. Although no current should be drawn from it, a complete internal disconnection may develop, causing bad quality and an excessive drain on the high-tension battery. The working life of the L.F. valve or valves will also be reduced.

Don't expect the best results from a modern circuit unless valves with characteristics closely approximating

to those specified by the designer are used. Nowadays, valves are carefully chosen with a view to the functions which they are to perform. If in doubt as to whether a certain type of valve can be substituted, write to the Information Department of *The Wireless World*, as queries of this nature are distinctly within its scope.

Don't adjust the detector of a valve-crystal combination (reflex or

otherwise) when both circuits are exactly in tune. It will be easier to set the crystal contact if one of the circuits is slightly de-tuned, and, moreover, there will be less risk of interfering with neighbouring listeners.

Don't overload any of the L.F. valves. It is hardly an exaggeration to say that more distortion is attributable to this cause than to any other. Reduce volume if necessary.

**DISSECTED DIAGRAMS.**

**Step-by-step Wiring in Theory and Practice.**

**No. 49 (a).—A Single-valve Reflex Receiver.**

(To be concluded in next week's issue.)

*In this series of diagrams it is hoped to make clear the steps to be taken in converting theory into practice in the construction of various typical wireless receivers. Provided that suitable components are chosen, the arrangement shown below is capable of giving very loud signals with a minimum upkeep cost. The prospective constructor is advised to read an article on this subject which appeared in "The Wireless World" for October 20th, 1926.*

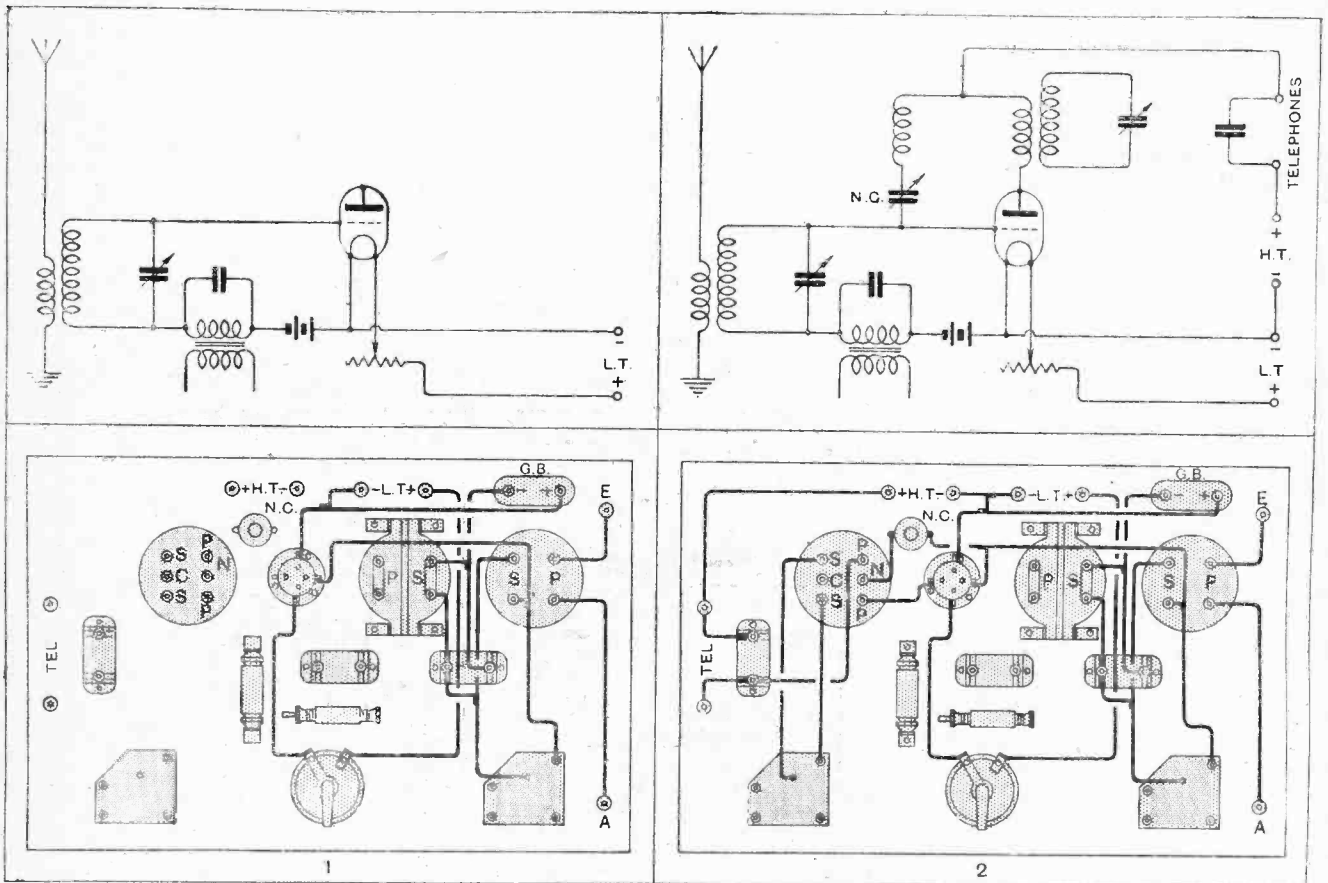

The valve filament circuit is completed in the usual manner. Aerial and earth are joined to the primary of a coupling transformer, the tuned secondary of which is connected between grid and filament. The secondary of the "feed-back" L.F. transformer and a bias battery are inserted in the lead from the low potential end of the tuned circuit to filament.

The plate circuit of the valve is completed through the primary of an H.F. transformer, telephones and the high tension battery. A winding in parallel with the transformer primary is connected back to grid through a stabilising condenser. High-frequency by-pass condensers are connected across the secondary of the L.F. transformer and the telephone terminals.

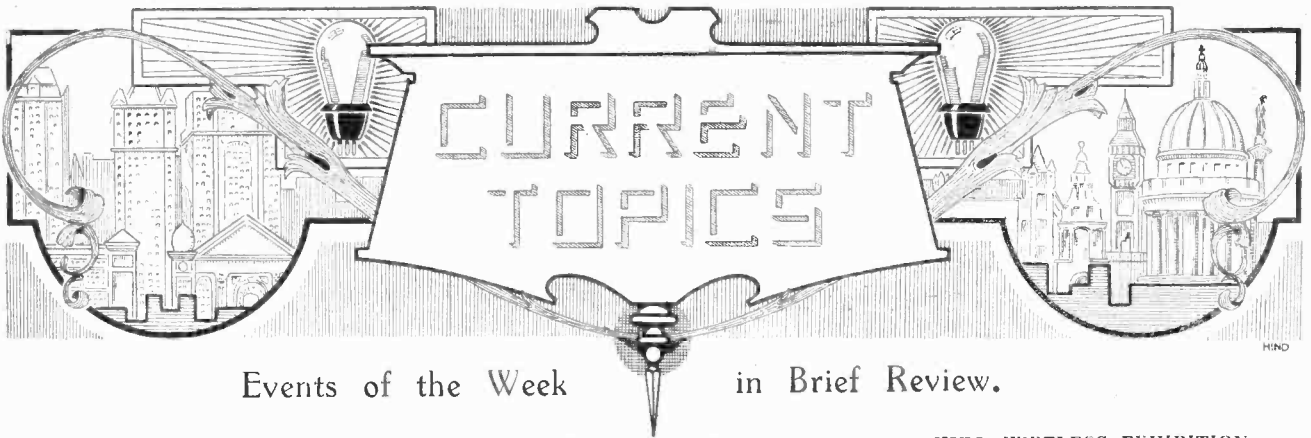

Events of the Week in Brief Review.

**QUEUE FOR THE WORKHOUSE ?**

Over £120 has been subscribed towards the installation of a wireless receiver in the Newmarket Workhouse.

o o o o

**THE UBIQUITOUS PIRATE.**

A Berlin report states that no fewer than 191 persons in that city have been fined in the last few days for using wireless sets without a licence.

o o o o

**SENATORE MARGONI AND THE I.E.E.**

Senatore G. Marconi, G.C.V.O., LL.D., D.Sc., has been elected an honorary member of the Institution of Electrical Engineers.

o o o o

**LATEST—AND OLDEST—IN LOUD-SPEAKERS.**

Men of the Vienna Fire Brigade now listen-in to broadcast programmes while "on watch" in the tower of St. Stephen's Cathedral. As a loud-speaker they have adapted an ancient megaphone used 300 years ago when the city was besieged by Turks.

o o o o

**COSTLY TALKS.**

A mysterious explosion has done damage to the extent of £4,000 at a broadcasting station operated by the Chamber of Commerce of Maplewood, New Jersey. The police believe that the destruction was caused by criminals who objected to recent broadcast talks on crime.

o o o o

**SUCCESS OF NATIONAL WIRELESS WEEK.**

Although it is still too early to determine with any exactitude how far National Wireless Week was successful in enlarging the ranks of wireless listeners, signs are not wanting of a keener public interest in broadcasting and wireless generally. That reliable mirror of public opinion, the daily and weekly Press, has reflected a very healthy awakening throughout the country.

It is significant that one London newspaper contained references to wireless and broadcasting on nearly every page. Next week we shall be in a better position to discuss the effects of the slogan, "Let Your Friends Listen."

**TELEVISION AT NEWCASTLE.**

Mr. J. L. Baird will demonstrate his system of television at the Palace Theatre, Newcastle, on Sunday, December 12th.

o o o o

**LOUD-SPEAKERS INDISPENSABLE.**

When the Rev. G. Campbell Morgan preached at Westminster Chapel last week, overflow congregations heard the service on loud-speakers in the institute and school halls.

o o o o

**SHORT WAVES FOR U.S. BROADCASTING ?**

Anticipating that the present confusion in the American ether will be overcome by the use of short waves for broadcasting, an American wireless firm is marketing a short wave unit for attachment to existing receivers.

**HULL WIRELESS EXHIBITION.**

The Hull Wireless Exhibition is to be held this year in the Drill Hall, Park Street, from December 4th-11th inclusive.

o o o o

**UNAUTHORISED TRANSMITTER PROSECUTED.**

For transmitting without a licence Cyril Joseph Smith, a motor engineer, of Timperley, Cheshire was last week fined £10 and £5 costs at Altrincham.

The defendant, who pleaded guilty, stated that he had originally applied for a transmitting licence two years ago and had had numerous letters and postcards stating that the application was receiving attention.

Mr. Frank Elliott, prosecuting on behalf of the Postmaster-General, said that it was in August, 1925, that the

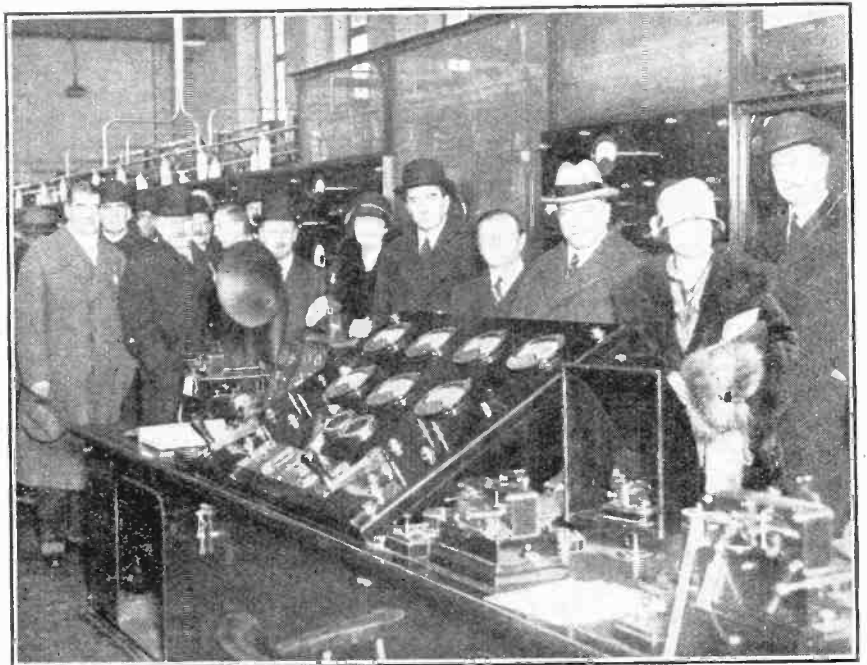

**DOMINION PREMIERS AT RUGBY.** On November 6th the Prime Ministers from Overseas visited the world's largest wireless station, where they inspected the apparatus in operation. In the above photograph the visitors are seen at the main control panel. Immediately behind them are the banks of water-cooled valves.

Post Office learnt that unauthorised transmissions were emanating from Timperley. By November the signals were traced to within a few yards of the defendant's home. A Post Office engineer called upon him and was shown two receiving sets which the defendant maintained were all the wireless apparatus he possessed. After this visit the messages ceased for a time, but in September last unauthorised messages were again heard, and the postal authorities obtained a search warrant. On going through the house they found a complete transmitting set.

In fining Smith, the magistrates described the case as a grave one, and ordered the apparatus to be forfeited.

o o o o

#### DOMINION PREMIERS AT RUGBY.

On November 6th the Dominion Premiers visited Rugby, where they saw the world's largest wireless station at work. Dr. W. H. Eccles, of the Wireless Commission, and Mr. E. H. Shaughnessy, of the Post Office, were among those who explained to the visitors the salient features of the apparatus and its operation. During the afternoon Mr. Bruce sent a message to Australia and members of the party were able to watch the processes of transmission. The message was despatched at the rate of 100 words per minute.

o o o o

#### INTERNATIONAL AMATEUR BROADCAST.

The American Radio Relay League announces that on November 27th Mr. Hiram Percy Maxim, president of the International Amateur Radio Union, will be the principal speaker in a special international amateur performance to be transmitted from 2XAF, Schenectady, N.Y., on 32.79 metres. This programme has been arranged at the special request of the South African Radio Relay League and through the courtesy of the General Electric Co.

The transmission will begin promptly at 11 p.m. G.M.T. on November 27th. Although addressed primarily to South African amateurs, it is hoped that the programme will interest listeners in Great Britain.

#### BROADCASTING CHARTER.

On Thursday last H.M. Stationery Office issued drafts of the Royal Charter for which the P.M.G. proposes to apply for the incorporation of the British Broadcasting Corporation, and the Licence and Agreement between the P.M.G. and the Governors Designate of the British Broadcasting Corporation. The Earl of Clarendon, chairman, will receive a salary of £3,000 per annum, the vice-chairman, Lord Gainford, £1,000 per annum, and each of the other Governors £700 per annum. Mr. J. C. W. Reith will be the first Director General, and will thus be the principal executive officer of the Corporation.

The Corporation will be empowered to collect news and subscribe to news agencies, and among other things will be able to acquire copyrights in literary, musical, and artistic works.

With regard to licences, the P.M.G.



**WIRELESS LEAGUE AT TOTTENHAM.** A very successful Exhibition, under the auspices of the local branch of the Wireless League, was held at Tottenham last week. Sir Arthur Stanley, who opened the Show, is seen at the League Stand. On his right is Mr. R. C. Morrison, the local member of Parliament. A feature of the Exhibition was the display of home-made apparatus.

undertakes, after the deduction of 12½ per cent. for administration, to pay the Corporation a sum equal to 90 per cent. in respect of the first million licences, 80 per cent. of the second million, 70 per cent. of the third million, and 60 per cent. in respect of all additional licences.

As mentioned in last week's issue of *The Wireless World* the British Broad-

casting Company receives £620,000 from the Postmaster-General in full settlement of all claims under the Principal and Supplementary Agreements. In other words, the company is "bought up" for that figure.

#### WIRELESS AT WESTMINSTER.

BY OUR PARLIAMENTARY CORRESPONDENT.

##### FREE WIRELESS FOR THE BLIND.

Parliament reassembled for the autumn session on Tuesday, November 9th, and on the following day Captain Fraser, the blind M.P., was successful in introducing a Bill to enable blind people to have the benefit of "free wireless." The measure was read a first time amid sympathetic cheers from all parts of the House, and will probably have a speedy passage into law.

The Bill proposes that where a person satisfies the Postmaster-General that he is a blind person within the meaning of the measure, a licence to establish, maintain, and work a wireless telegraphy station for the purpose of receiving messages only may be granted to him by the Postmaster-General subject to such terms, conditions, and restrictions as the Postmaster-General may think fit, but without the payment of a fee.

Captain Fraser said that at the most the loss to the revenue would not be more than £15,000 to £20,000. Many institutions for the blind supported the Bill, which had the approval of the Treasury, the Ministry of Health, and the Post Office. The Bill would facilitate the use of this latest invention which meant more to the blind than any other class of the community.

#### FORTHCOMING EVENTS.

##### WEDNESDAY, NOVEMBER 17th.

*Muswell Hill and District Radio Society.*—At 8 p.m. At Tollington School, Tetherdown. Short talk on "The Short Path Valves," by Mr. T. Franklin (Metrovicks, Ltd.).  
*Edinburgh and District Radio Society.*—At 8 p.m. At 117, George Street. "One Valve" Night.  
*Barnsley and District Wireless Association.*—At 8 p.m. At 22, Market Street, Barnsley. Illustrated lecture: "Mica Condensers," by Mr. B. Heywood, of the Dubilier Condenser Co.  
*Wireless and Experimental Association.*—At 8 p.m. At the Camberrill Central Library, Peckham. Discussion on "The Superheterodyne."

##### THURSDAY, NOVEMBER 18th.

*Golders Green and Hendon Radio Society.*—At 8 p.m. At the Club House, Wilfield Way, Golders Green, N.W.11. Demonstration: "Battery Elimination" by Mr. F. H. Haynes, of *The Wireless World*.

##### FRIDAY, NOVEMBER 19th.

*Radio Experimental Society of Manchester.*—At the Athenaeum. Lecture by Mr. E. Butterworth, E.Sc., and Demonstration by Mr. H. Frearson. Subject: "The Superheterodyne."  
*Sheffield and District Wireless Society.*—Lecture: "Condensers," by Mr. Heywood (of the Dubilier Co.).  
*Leeds Radio Society.*—At 8 p.m. At Collyer's Cafe, Wellington Street. Question Night.  
*Junior Institution of Engineers.*—At 7.50 p.m. At 39, Victoria Street, S.W.1. Lecture: "Short-wave Wireless Communication," by Mr. B. J. Aaton Y.M.Cher).



# The Radio Ship "TELEARCH I."

(Continued from page 572 of October 27th issue.)

By A. P. CASTELLAIN, B.Sc., A.C.G.I., D.I.C.

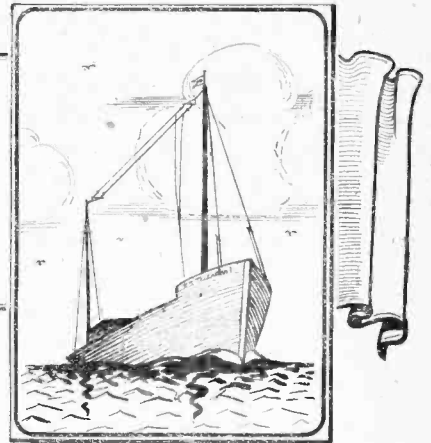

## The Construction and Operation of the Rotary Relay.

THE first part of this detailed description of the radio ship *Telearch I* dealt with the construction of the screened radio receiver, and the next part to be described is the relay panel, or "electric brain"—perhaps the most interesting component in the whole boat.

In the radio receiver the transmitted impulses on 90 metres wavelength are changed into fluctuations of current in the plate circuit of the valve, while in the "electric brain" these current fluctuations are used, according to their number, to operate the various devices which actually control the ship. The current fluctuations in the plate circuit of the valve in the receiver serve to operate a sensitive but robust relay, which in turn completes a circuit containing a six-volt accumulator and the coil of another relay (see Fig. 7). This second relay is of the rotary, as opposed to the ordinary single movement, type, *i.e.*, the functions of such a relay are similar to those of a multi-position barrel switch, while those of the ordinary type of relay (such as the first one referred to) may be compared with an ordinary on and off switch.

(armature) mounted above the coils on a rectangular brass bar (L, Fig. 8) pivoted at one end. The iron strip is kept above the core by a small spiral spring fixed to the pivoted end of the brass bar, and when a current flows round the coil the strip is attracted and the bar with it, thus extending the spiral spring. The unpivoted end of the bar L carries a small strip of brass, with a pawl K

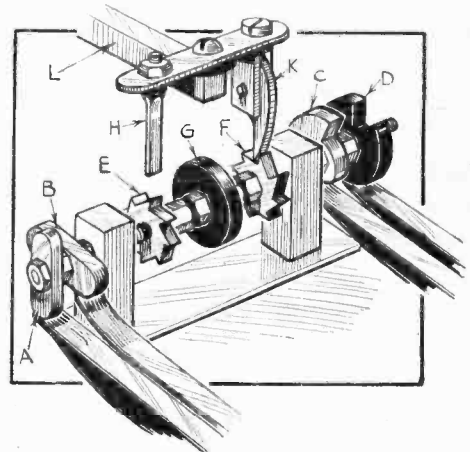

Fig. 8.—Detailed sketch of the bar and ratchet wheels of the rotary relay.

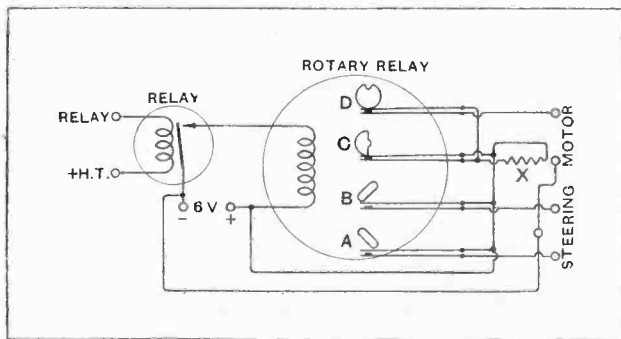

Fig. 7.—Circuit diagram of the relays.

The actual way in which the *rotary relay*, as it is called, functions, may be gathered on reference to Fig. 8 and also the plan photograph of the panel or the layout shown in Fig. 9. First of all we will see how the relay operates, and then see how the motor and the steering gear are controlled by the relay.

The rotary relay consists essentially of two coils of wire on a U-shaped soft iron core, with a soft iron strip

and a stop H (see Fig. 8) mounted on it. Underneath this end of the bar on the baseboard is mounted a shaft carrying various cams A, B, C and D, and also two ratchet wheels E and F, which latter are immediately under H and K respectively. While the bar is being depressed (*i.e.*, when a current is flowing round the relay coils) the pawl K engages in one of the teeth of the ratchet wheel F, and rotates the latter until the stop H comes up against one of the teeth of its ratchet wheel E.

### Relay Cams.

E and F are so arranged on the shaft that each full depression of the bar corresponds to a rotation of the shaft of one tooth on the ratchet wheel—*i.e.*, in this case one-eighth of a revolution as there are eight teeth to the ratchet wheels in the relay used.

By now it will be seen that the position of the cams on the shaft depends on the number of current impulses

**The Radio Ship "Telearch I."**—

that have flowed round the coils of the rotary relay—four impulses giving half a revolution and eight a complete revolution, and so on.

We have now to consider the functions and shapes of the cams A, B, C and D. Cams A and B are to control

tions, and three "half speed" positions, while the steering would be successively straight, left, straight, right, straight, left, and so on round the eight positions.

The various operations of the cams will then be as shown in the table.

Thus, supposing the motor was "off" and the boat

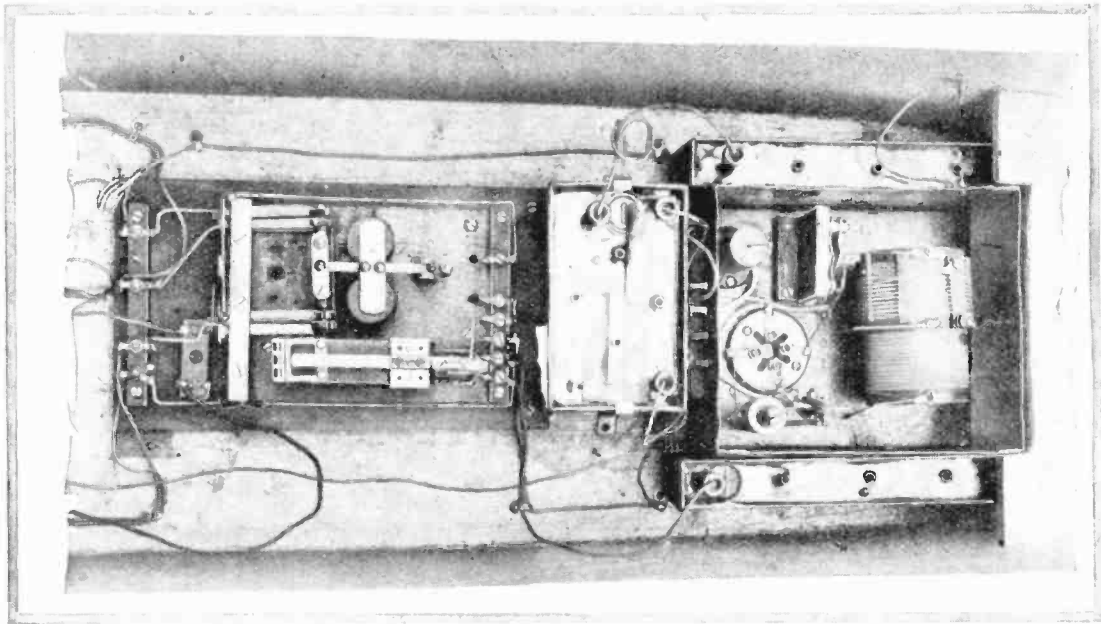

Plan photograph showing the arrangement of the relay.

the steering gear, to left and to right respectively, while C control motor speed and D the starting and stopping of the motor.

The arrangement finally adopted was to have one "off" position for the motor, four "full speed" posi-

was required to go full speed ahead, two impulses would be sent from the transmitter, which would put the shaft in position 2.

If it was then desired to stop the boat six impulses would be given, which would bring the shaft round to

position 0 again. It should perhaps be made quite clear that owing to the ratchet wheels and the stop H the shaft can only rotate in one direction, so that to get from one position to the one before means seven impulses. The reader will probably here raise the objection that all the other functions of the controls are, or may be, gone through on the way to the right one, but in practice this objection falls to the ground because the shaft of the rotary relay reaches the desired position before the intermediate controls have time to operate.

The time taken for the various controls to operate when the boat is in the water is purposely made

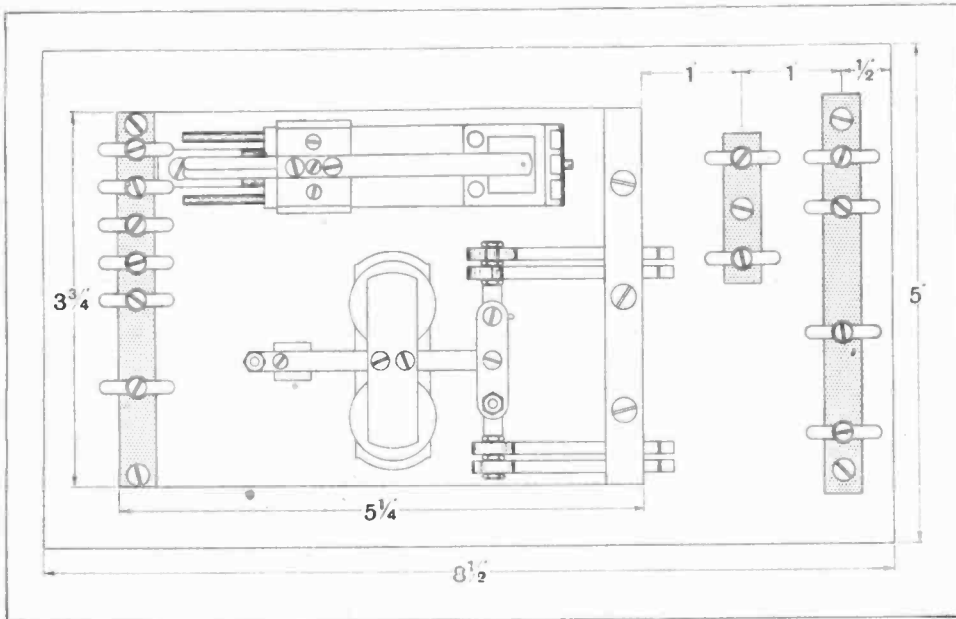

Fig. 9.—Dimension diagram of the rotary relay unit.

**The Radio Ship "Telearch I."**—

large so as to give time for the relay shaft to rotate at a reasonable speed—say, not exceeding a maximum rate of 20 revs. per minute. The way in which the controls are made to operate on the boat comparatively slowly is extremely simple, and, in fact, it would be rather difficult to obtain very rapid operation in such a small boat.

In the case of the motor—suppose the rotary relay went through position 0 (motor "off"), as it does on its way between half speed ahead (position 6) and full speed ahead (position 2)—owing to the weight of the boat, and the fact that it is moving, *i.e.*, it has "way" on, stopping the motor for a very short time will not affect the speed of the boat

Position of Shaft.	Motor.	Steering.
0	Off	Straight (S)
1	Full speed	Left (L)
2	"	S
3	"	Right (R)
4	"	S
5	Half speed	L
6	"	S
7	"	R

In the case of the steering gear, the rudder is made of fairly large area so that it takes a little time to swing over to left or to right so that a momentary current flowing round the steering magnet coils will not affect the rudder at all.

It may be thought that this way of getting over one of the difficulties of impulse control with a rotary relay is very crude, but it is very effective on *Telearch I*, and it must not be forgotten that *Telearch I* is a very small object to be controlled by radio, and that the simplest

possible methods must be used owing to space restrictions. It should also be emphasised very strongly that it is a much more difficult job to fit out a small model like *Telearch I* for radio control than something of the order of a large motor boat, for example, since in the latter a much larger aerial could be used and much more room would be available. For controlling a motor boat the radio receiver and rotary relay panel would be almost exactly similar in type to those of *Telearch I*, although there would naturally be further robust relays to operate the steering motor and to control ignition and fuel supply, etc., to the propellor motor, and in a motor boat the radio receiver and relay panel would occupy a negligible amount of space instead of more than half the available amount as in *Telearch I*.

Returning to the details of the rotary relay, the next point to be dealt with is the shape of the various cams. As will be seen in diagram Fig. 7, these cams merely serve each to close a pair of contacts, which in the case of the steering cams close the circuit of the left or the right steering magnet—one cam to one magnet—and in the case of the motor cams, cam C short circuits or open circuits resistance X in series with the motor, and thus gives full speed and half speed respectively, while cam D, made of ebonite or other insulator (if the remaining cams are made of brass) gives one position where its contacts are open, thus shutting off the motor.

The actual relays used in *Telearch I* are a Siemens P.O. type 10,000 ohms operating at 1 milliamp for the first relay and a converted Gamage "push-control" relay used for remote control of radio receiving sets.

Fig. 9 gives the layout and dimensions of the relay panel, and shows the way in which the contact strips (made of steel watch spring with silver contacts) are clamped

(To be continued.)

# IDENTIFYING FOREIGN TRANSMISSIONS.

## An International System of Call-signs Based on the Use of Esperanto.

By C. F. CARR.

THESE can be no doubt that international broadcasting will loom very large in the future. The number of high-power stations on the Continent is increasing and English listeners are discovering that their transmissions give a spice of variety to the evening programme of music which the wireless receiver now provides in almost every home. To-day several of the Continental stations, especially those of France, Germany and Spain, come in with very good strength, and the ordinary non-technical listener is frequently surprised when he experimentally turns his tuning condenser to find foreign stations rolling in one after the other and giving quite clear signals. Until a comparatively short time ago the reception of these foreign stations could not be relied upon, and they were red-letter nights when two or three of them could be joyfully located. Nowadays there is not so much suggestion of "reaching out" as there used to be. There are numerous foreign stations which, all things being equal, can be relied upon to come in as regularly

as some of our own main stations. With a gradual improvement in the technical equipment of these distant stations and the increasing of their power, foreign broadcasting is certain to become more and more attractive to listeners in Britain.

### The New Wavelengths.

The rapid growth of European broadcasting during the past two or three years has produced a number of problems, the principal one of which, of course, was the tangle of transmissions on near wavelengths which made certain aspects of Continental wireless transmission something of a nightmare to listeners on this side of the Channel, owing to the serious interference with some of our own programmes. This particular problem has now been tackled, and it is hoped that the allocation of new wavelengths, which is to come into force at the end of next month, will mark the commencement of an era of orderliness in the broadcasting household of Europe.

**Identifying Foreign Transmissions.—**

But there is still another problem to be solved, and it is one in which there would appear to be much less difficulty than there was in the regulation of wavelengths. It is the problem of the easy identification of Continental and other foreign stations, so that every listener may be able to discover the source of any transmission very soon after he has commenced to receive it. To-day the system of announcing stations may prove entirely satisfactory to the listeners who are within their own special service area, but as far as listeners in other countries are concerned it is a pure farce and quite inadequate to meet the needs of a service which is becoming more and more international every week. It is obvious that some means will have to be adopted, and that very soon, of so announcing stations that the listeners of all nationalities will immediately comprehend the "call" and have no doubt as to the identity of the transmission. The remedy is so simple that it is more than surprising that the confusion which now exists has been allowed to continue for so long.

**False Identification.**

What is urgently needed is the adoption throughout the world of a system of international call signs—a development which is bound to come about within two or three years. By this means station identification would be a perfectly simple process. No radical upheaval would be required and the only unfortunate individual who would lose his job would be the man who tries to inform puzzled listeners "Which Station Was That?" through the medium of a B.B.C. organ. "Station Identification Panels" and identification booklets, which are all very well in their way and afford useful assistance, would immediately become a thing of the past.

For the ordinary listener the identification of a foreign station is at present surrounded by a variety of difficulties. Take an instance of what may occur to such a listener any evening. He is seeking variation from his local station or from Daventry and picks up a station which comes in strongly on a wavelength which he knows to be somewhere between the wavelengths of Bournemouth and Aberdeen. Someone is speaking when he tunes in, and the language he recognises as German. After waiting patiently for five minutes he hears "Berlin" mentioned and instantly jumps to the conclusion that it is the Berlin station to which he is listening. It is quite possible, however, that he is all wrong, and that the station he is listening to is Frankfurt and that the speaker has merely mentioned Berlin in the course of a talk or a news bulletin. Similar confusion can easily occur when listening to one of the Spanish stations. Cadiz, Barcelona and San Sebastian may all mention Madrid or one another several times in the course of a single evening.

**International Code.**

What, then, is required is some easily understood international code which shall instantly pin down the identity of a station beyond all manner of doubt. An ordinary call-sign, such as 6BM, 5WA, EAJ11 or CFR is of no use whatever for such a purpose. Its letters and numerals would invariably be announced in their national equivalents and thus could not be understood by anyone who

did not know the language in which the announcement happened to be made. Use will have to be made of international call-signs which do not vary in significance or pronunciation and are thus standardised to the intelligence of listeners of every nationality. The pronunciation difficulty, it is easy to realise, would preclude the use of an ordinary code founded on the letters of the alphabet, for the pronunciation of these letters would vary in every country, and the whole scheme would be nullified. The first need is obviously unvarying pronunciation, and for this reason the scheme which I have drawn up is founded on the standardised international pronunciation of Esperanto, which has already linked itself very effectively to radio broadcasting on the Continent, and of which we shall probably hear a good deal more in the future.

**Call Signs in Esperanto.**

First of all, each country must have a preliminary code word. Then my scheme denotes each station by a serial number, the numbers being allotted in order of importance of the stations. From the following examples it will be seen that the plan is simplicity itself. We will suppose that London is calling. It announces in the ordinary way and then gives its international call-sign: "Brita Stacio Unu." This is pronounced *Breetah Statsioh Oonoo*, and means "British station one." Cardiff would announce "Brita Stacio Du" (British station two), Bournemouth "Brita Stacio Tri" (British station three), and so on, using the Esperanto numerals unu, du, tri, kvar, kvin, ses, sep, ok, nau, dek, etc., as the serial numbers for the stations.

The same idea would be applied to the foreign station. Germany would use the same numbers in a similar way. Berlin, for instance, would announce, after its local call, "Germana Stacio Unu," and the other German stations would follow on with the remaining numbers. The French stations would announce "Franca Stacio Unu, Du, Tri," and so on, each station having its own serial number, and the same would apply to the Spanish (Hispana) stations and those of other countries.

**Advantages of the Scheme.**

By the use of this scheme, or a similar one, all identification difficulties would be removed once and for all, and the only guide that would be required in place of the present identification panels and wavelength tables would be a brief table of the serial numbers allotted in each country. This would merely take up the space of a single station identification panel as published to-day. There would be no confusion, and the open vowels in the standard Esperanto pronunciation would overcome the difficulty which would inevitably arise if any other system of announcement were used. Secondly, the Esperanto names of the countries could be learned in a few minutes, which would not be the case if a complicated artificial code had to be memorised.

[The use of Morse characters for purposes of identification has already been suggested and discussed in the Correspondence columns. Readers' views and comments on the feasibility of the above outlined scheme would be welcomed.—ED.]

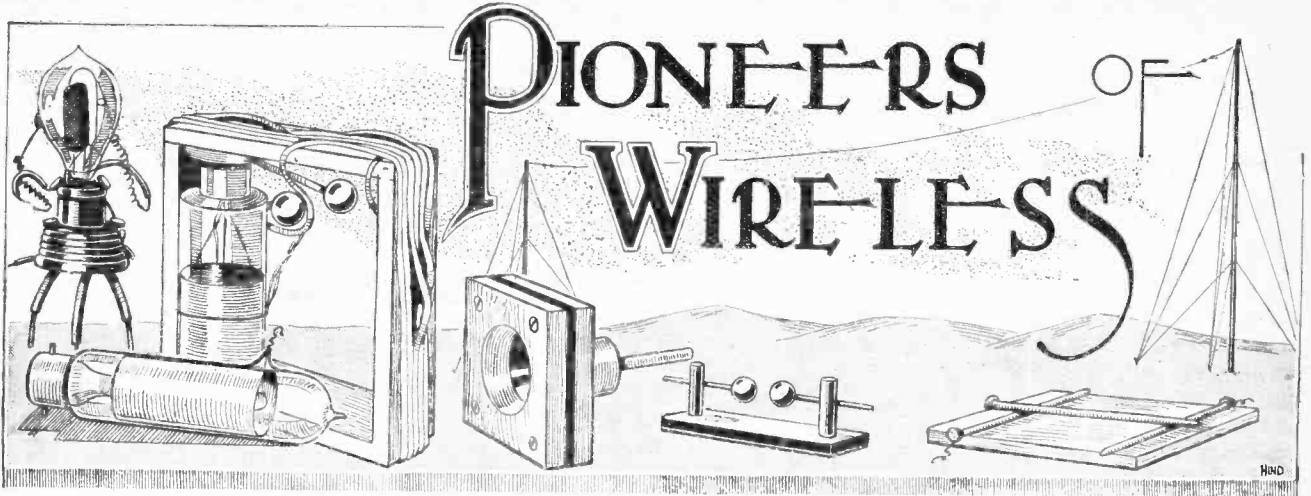

### 35.—Marconi Bridges the Atlantic.

By ELLISON HAWKS, F.R.A.S.

**A**LTHOUGH Marconi had enormously improved the Branly coherer in sensitivity, it became increasingly evident as time went on that a more sensitive detector would have to be found if wireless was to be a commercial success. Even up to the time of the introduction of tuning, Marconi was using the coherer. This was very unsatisfactory, for the apparatus not only required frequent adjustment, but it was not sufficiently sensitive, and was so slow in its working that a maximum speed of only 16 or 18 words per minute could be attained. As it could only be used over comparatively

short distances, it was altogether unsuitable for high-speed, long-distance commercial working.

#### Introduction of the Magnetic Detector.

Marconi, therefore, commenced experiments in order to further develop this part of his apparatus, and in 1902 he introduced the magnetic detector. This consisted of an endless moving band of soft iron wire, mounted on two wooden pulleys rotated by clockwork and passing close to the poles of two horse-shoe magnets. The principle of this detector depended on the fact that as the moving band passed from the influence of one magnet to that of another, the magnetism became reversed. The change was not accomplished instantaneously, however, but required a certain minute fraction of time to complete. This is accounted for by the fact that the iron for a short space of time resists the attempt of one magnet to reverse the effect of the other.

At one place the iron wire passed through two small glass tubes, on which was wound silk-covered copper wire. One of these coils was connected to a telephone receiver, and the other connected in the aerial circuit. In 1831 Michael Faraday, one of the most brilliant of British scientists, had showed that if a magnet be moved near a coil of wire an electric current is induced in the wire. An exactly similar

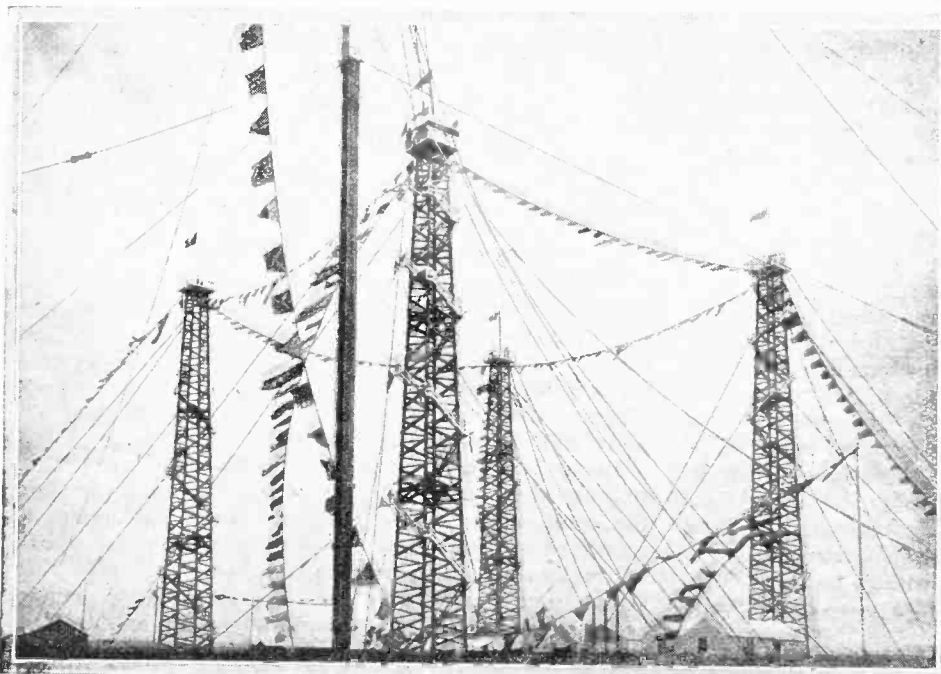

The Poldhu Wireless Station decorated on the occasion of its opening by H.R.H. Prince of Wales in 1902. The Royal visitor was at the top of the nearest mast when the photograph was taken.



**Pioneers of Wireless.—**

occurrence takes place if the magnet is stationary and the wire moving, as was the case in Marconi's magnetic detector.

Thus, so long as the state of the coil was normal, there was a constant current flowing in the iron wire. When electrical waves were received by the aerial, however, their impulses instantly caused a reversal of the magnetism in the iron wire. The effect of this sudden moving of the lines of magnetic force was to induce a current in the second coil, the result being the production of an audible "click" in the telephone earpiece.

The magnetic detector had the advantage of being always ready for work and requiring no attention, except the winding at intervals of the clockwork mechanism that drove the moving band.

**Transatlantic Communication.**

With this improved apparatus, Marconi sent (in January, 1901) signals from St. Catherine's, in the Isle of Wight, to the Lizard, in Cornwall (155 miles), using a 10-inch spark coil. In this same year the first long-distance station was established at Poldhu, in Cornwall, and Marconi next turned his attention to an attempt to signal across the Atlantic from this new station. He realised that Leyden jars as condensers, and batteries for power, would not give sufficient energy to accomplish his object. A problem such as this demanded the production of electric waves on a scale so great as had never been attempted before. A 25 h.p. oil engine was therefore installed, along with an alternator that gave a low-frequency current of 2,000 volts. This current, raised to 20,000 volts by transformers, charged a large number of condensers, which were really huge Leyden jars composed of glass plates coated on each side with tinfoil and immersed in oil in stone containers.

December 12th, 1901, will for ever stand indelibly imprinted in the history of wireless, for on that day Marconi, stationed at St. John's, Newfoundland, received the first signals from the far-distant station at Poldhu, thus bridging the Atlantic. It is true that the first "message" was but the constantly repeated letter "S," but to Marconi's ears it must have been soul-stirring in effect. The public were incredulous at the accomplishment of the seemingly impossible. Their surprise was increased when, the following month, Marconi apparatus on the liner *Philadelphia*, on a voyage to New York, received signals from Poldhu up to a distance of 2,099 miles.

Towards the end of 1902 stations were erected at Glace Bay (Cape Breton, Nova Scotia) and Cape Cod (Mass., U.S.A.) for transatlantic communication with

another new station at Clifden (in Galway, West Ireland). Several improvements were introduced in these powerful stations, including Marconi's disc discharger and the newly invented air condensers, which consisted of insulated metal sheets, suspended in air, in place of the glass and tin-foil previously used.

On December 22nd, 1902, Marconi sent the following wireless telegram to King Edward at Buckingham Palace:—

"On occasion of first wireless telegraphic communication across Atlantic Ocean may I be permitted to present, by means of this wireless message transmitted from Canada to England, my respectful homage to his Majesty the King.—MARCONI."

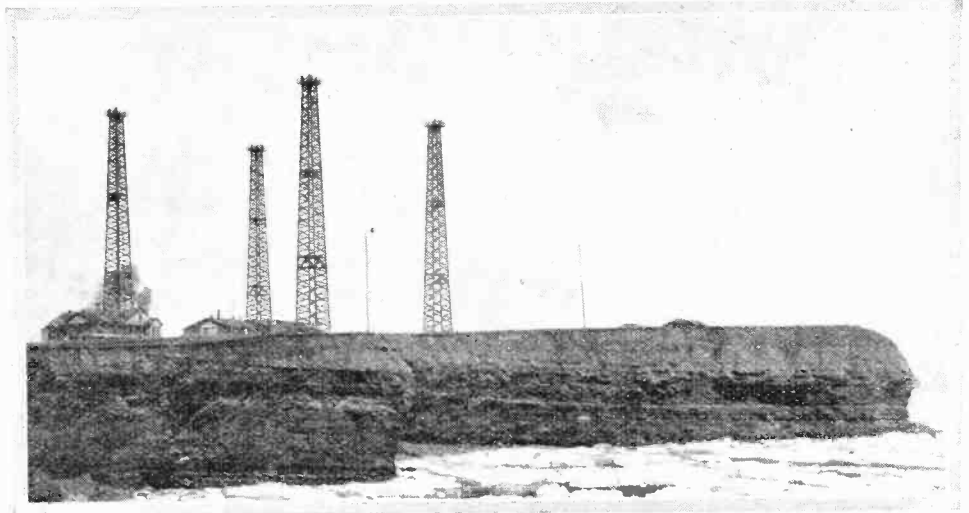

The Glace Bay Station, Newfoundland, which was erected shortly after Marconi's successful transatlantic experiment.

Transatlantic communication now became general, and on March 30th, 1903, *The Times* contracted with Marconi for regular transmission of news from the New to the Old World.

In 1904 the first ocean newspaper, *Cunard Daily Bulletin*, was published on the R.M.S. *Campania*, printing news items received by wireless from Poldhu.

**Discovery of the Directional Aerial.**

Resulting from his experience in the erection of the new station at Clifden, Marconi designed what was at that time the largest station in the world. This was situated at Coltano, near Pisa (Italy), where the power was 400 h.p. (300 kW.). This station maintained regular communication over a distance of 2,238 miles day and night with Massana (East Africa).

In 1905 Marconi found that signals were heard more strongly when the receiving aerial was directed away from the transmitting station, with the receiving apparatus connected at that end of the aerial nearest to the transmitting station. In transmitting, he found also that signals were stronger in a given direction when a similar aerial arrangement was employed. Up to this time vertical antennæ had generally been used, but in these experiments horizontal antennæ were used, and were found to give greatly improved results. An aerial of

**Pioneers of Wireless.—**

this type, used for transmitting, radiates most of its energy in the direction opposite to that to which the free end is directed. With horizontal receiving and transmitting aerials placed "back to back," and the free ends pointing away from each other, the range was found to be very much greater than with the vertical and undirective aerials formerly employed.

**Marconi Stations Taken Over by G.P.O.**

In 1907 a regular Press service was opened and made use of in this country by *The Times*, and in America by the *New York Times*. In the first five months' service over 68,000 words were promptly and efficiently transmitted for the *New York Times*. Soon after, however, the service was interrupted by disaster to the station at Glace Bay, which was burned down. It was decided to build a new station, and also to reconstruct the station at Clifden, and these alterations interrupted the service until April 23rd, 1910.

In 1910 the Post Office took over the Marconi coast stations in Great Britain, and a scheme was entered into in the following March to establish a chain of wireless stations around the Empire. Stations were to be erected

at London, Egypt, Aden, Bangalore (India), Pretoria (South Africa), Singapore, and Hong Kong, with an extension from Singapore to Port Darwin, where the Australian Government were to erect a station. Bitter discussions subsequently took place in Parliament as to the terms of the agreement, and a revised contract was entered into in 1913. (It was not until 1919 that a commencement was made to erect the stations at Leaffield, near Oxford, and Abu Zabal, the Egyptian station near Cairo.) The war broke out, and a modified plan was subsequently substituted for the scheme. This consisted of the erection, for communication with ships, of medium-power stations at Jamaica, Bermuda, St. John's, Demerara, Aden, Mauritius, Durban, Port Nolloth, Gambia, Seychelles, Ceylon, Singapore, Hong Kong, Ascension; and the Falkland Islands. These stations were of considerable service during the war, since when the station at Leaffield has been completed, and is now working with Cairo. More recently the new high power stations at Rugby and Bridgewater have been completed.

**NEXT INSTALMENT.**

**Fessenden, Pioneer of the Wireless Telephone.**

**General Notes.**

Mr. F. R. Neill (GI 5NJ), the well-known amateur at Whitehead, Co. Antrim, tells us that he was in two-way communication with BN 8K2, Mr. H. G. Gray, Kiching, Sarawak, on the evening of Sunday, October 31st, his signals being reported R5. He was using 75 watts to a D.E.T.1 valve. He was also in touch with O A5X (Johannesburg), A 2YI and HRB (Australia), as well as a European station, thereby communicating with four continents in the space of two hours.

Mr. G. F. Kitchen (G 5VP), 10, Beech Road, Epsom, wishes us to say that he has returned to his old address and hopes soon to be "on the air" again, when further co-operation with old friends will be welcomed.

Mr. A. J. Baker (G 6QH), 23, Third Avenue, Bush Hill Park, Enfield, whose experiments we noted in our issue of November 3rd, tells us that on November 6th he exchanged signals with U 2DM, and, the following day, with U 1CI, using an input of 6 watts as before and with an aerial 45 metres in length. His signals were reported as R3.

**Reception of American Broadcasting.**

We understand from the General Electric Company, Schenectady, that, in accordance with the present short-wave schedule, the station 2XAF, operating on 32.79 metres, transmits the evening programme of WGY on Tuesdays and Saturdays. On each of these evenings the programme is usually continuous from 6 p.m. E.S.T. until about midnight E.S.T. Transmissions from their other low-wave stations are subject to frequent changes on account of the experimental and developmental investigations that are being carried on by

**TRANSMITTERS' NOTES  
AND QUERIES.**

this company. This makes it impossible to keep listeners fully acquainted with all their schedules; however, at 6.45 p.m. E.S.T. each Saturday, the complete schedule for the ensuing week is transmitted by 1CW telegraph from 2XAF.

A correspondent in Birmingham writes that he receives U 2XAF and 2XAD with great regularity on 26.8 and 32.79 metres, and on the morning of Sunday, October 24th, he received the former station between 0830 and 1030 G.M.T. when it was daylight over practically the whole of the Atlantic. Signals remained strong, without any fading until 1030. He also frequently hears U 2SG, with his monotonous "If you understand, colleague, write it down," transmitting on 35 and 28 metres. The receiver is a 1-valve Special Reinartz with which he can tune down to 4 metres.

Incidentally, this correspondent states that he will be very glad to co-operate with any of our readers, transmitters or otherwise, who require a receiving station to report on experiments. His address is John L. Harman, 506, Chester Road, Edington, Birmingham.

A correspondent from Warrington states that about midnight on Saturday, October 30th, he heard U 2XAF on 32.76 metres broadcasting a special time-signal to "Mr. Frances Smith, explorer, somewhere in the wilds of Brazil." The last

dot of a long series of slow ones "was exactly 10 minutes after seven o'clock (19-10) Eastern American time," the announcer said. A short musical programme followed, and then a political speech by Dr. Richmond. Our correspondent had this station for 1½ hours and heard every word at good loud-speaker strength on a cone type speaker. Static was nil, but a little fading at about 5-second intervals.

**Time Signals on Short Wavelengths.**

0320 G.M.T.	Arlington NKL or Bellevue NKF on 24.9 metres. Rhythmic Signals 306 dots.
0320	Arlington NKL on 74.7 metres. Rhythmic Signals 306 dots.
0340	Honolulu NPM on 36.8 metres. Rhythmic Signals 306 dots.
0756	Issy les Moulineaux OCDD on 32 metres. International "Onogo."
0806	Issy les Moulineaux OCDD on 32 metres. Rhythmic Signals 306 dots.
1020	Arlington NKL or Bellevue NKF on 24.9 metres. Rhythmic Signals 306 dots.
1020	Arlington NKF on 74.7 metres. Rhythmic Signals 306 dots.
1040	Honolulu NPM on 36.8 metres. Rhythmic Signals 306 dots.
1130	Saigon HZA on 25.0 metres. Rhythmic Signals 306 dots.
1900	Saigon HZA on 25.0 metres. Rhythmic Signals 306 dots.
1955	Issy les Moulineaux OCDD on 32.0 metres. International "Onogo."
2006	Issy les Moulineaux OCDD on 32.0 metres. Rhythmic Signals 306 dots.
2020	Arlington NKL or Bellevue NKF on 24.9 metres. Rhythmic Signals 306 dots.
2020	Arlington NKL on 74.7 metres. Rhythmic Signals 306 dots.
2040	Honolulu NPM on 36.8 metres. Rhythmic Signals 306 dots.

**New Call-Signs and Stations Identified.**

G 2CB	(Ex 2BJK). C. A. J. Brooks, 7, Merivale Road, Putney, S.W.15. Transmits on 45 metres.
G 6AI	R. F. P. Collins, 67, Lucien Road, S.W.17.
G 6SF	E. Saltmarsh, Sandridge, near St. Albans.
G 2AUX	C. S. Bradley, 10, Montenoire Road, N.8.

## SUPERSONIC TRANSFORMERS.

## PART II.

## Measurement of Magnification Curves and Valve Coefficients.

By N. W. McLACHLAN, D.Sc., M.I.E.E., F.Inst.P.

THE diagram of connections for the above process is shown in Fig. 5. A local oscillator covering the desired band of wavelengths is loosely coupled *via* a filter circuit (to suppress harmonics) to a coil across the grid and filament of valve  $V_1$ . In parallel with the coil is a variable, non-inductive resistance with a tapping point, thus giving a potentiometer arrangement. The resistance

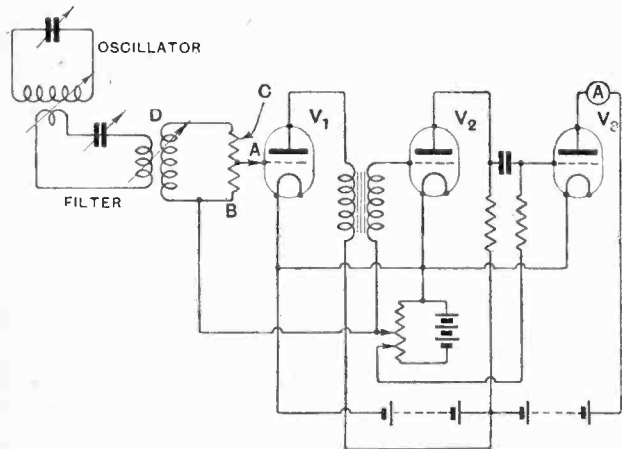

Fig. 5.—Circuit used to determine transformer amplification curves. The total step due to  $V_1$  and the transformer is measured.

is variable in small steps. The transformer under test is connected in the anode circuit of  $V_1$  in the usual way, *i.e.*, primary outer to anode and secondary outer to grid. The secondary is connected to the grid of  $V_2$ , and  $V_2$  is resistance capacity coupled to  $V_3$ , which is set to rectify.<sup>1</sup> A microammeter is connected in the anode circuit of  $V_3$ . It will be observed that grid bias is applied to  $V_1$  and  $V_2$  to avoid grid current. The signals to  $V_1$  are applied between AB, this being a fraction of the total voltage induced in the coil D. Conditions are arranged to get a suitable deflection on the microammeter, none of the valves running to grid current.  $V_1$  and the transformer are then cut out of circuit by a switch, and the tapping point C of the potentiometer applied to the grid of  $V_2$ . The value of the resistance across D is constant, but BC is adjusted until the microammeter reads the same as before.

<sup>1</sup> The influence of  $V_2$  on the performance of the transformer will be treated separately. In effect it augments the secondary self-capacity.

The ratio  $\frac{BC}{AB}$  is the magnification of valve and transformer. It is necessary that the filament and H.T. conditions should be identical for both tests, and therefore when switching occurs  $V_1$  is left with the same grid bias, same H.T., and same filament current. This will be clear from the switching diagram. By making AB some value suitable for computation, the amplification curve can be taken quite quickly. From an inspection of the above, errors of large magnitude would not be expected, and we are probably on the safe side in saying that the results are accurate to at least  $\pm 5$  per cent. In any case, there is no particular reason for tremendous accuracy, for a 5 per cent. difference is of little moment when acoustic intensities are in question. The wavelength, however, should be reasonably correct to secure accurate values of other coefficients, and proper matching of transformers, unless, of course, these are always tested on the same set.

In taking measurements with various valves it is necessary to know the value of "m" before the effective step of the transformer can be ascertained. Also, in computing the effective resistance of the transformer, it is essential to have  $\rho$ . The mode of arriving at these coefficients is due to Mr. E.C. Cork, M.Sc., and is given below. The circuit is set at a wavelength giving maximum amplification (approximately, zero reactance) and the magnification ascertained. An inductionless resistance is placed across the primary of the transformer,

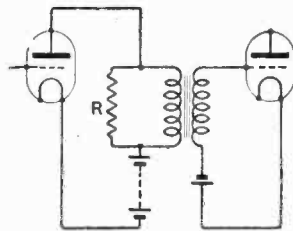
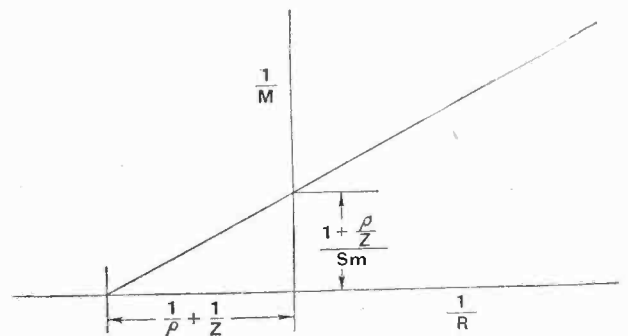

Fig. 6.—Graphical method of ascertaining the value of  $\rho$  for a valve. The slope of the line is  $\frac{\rho}{Sm}$ , where S = turns ratio, m = amplification factor,  $\rho$  = internal resistance of valve, M = actual magnification of valve and transformer, Z = impedance of transformer at resonance, R = non-inductive resistance across primary.



and the magnification measured again. The process is repeated with other resistances.

When the *reciprocals* of resistance and magnification are plotted, the points lie on a straight line, as shown in Fig. 6.

Using a transformer of high primary inductance and low ratio, the value of "m" can be determined to a

**Supersonic Transformers.—Part II.—**

first approximation,<sup>2</sup> provided the same filament current, anode volts, and grid bias are used in subsequent tests on other transformers. This method was adopted, and the value of  $\rho$  calculated from the relation slope =  $\rho/sm$ . The results obtained were quite consistent for the low resistance valves, and calculations of other coefficients, e.g., effective resistance, which were dependent

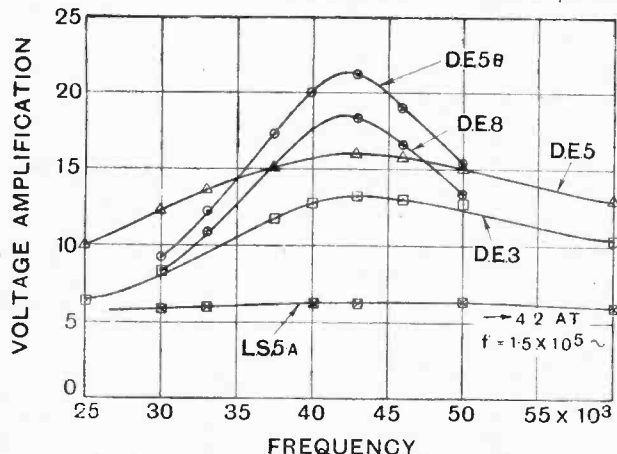

Fig. 7.—Amplification curves for No. 1 transformer.

on the value of "m" were in close agreement when determined with different classes of valve. With the D.E.8 H.F. valves there was always a tendency for the calculated effective resistance to be on the high side, and this was probably due to the actual  $\rho$  value being different from the  $\rho$  value with the higher impedance transformer. A perusal of the "m" and  $\rho$  values will

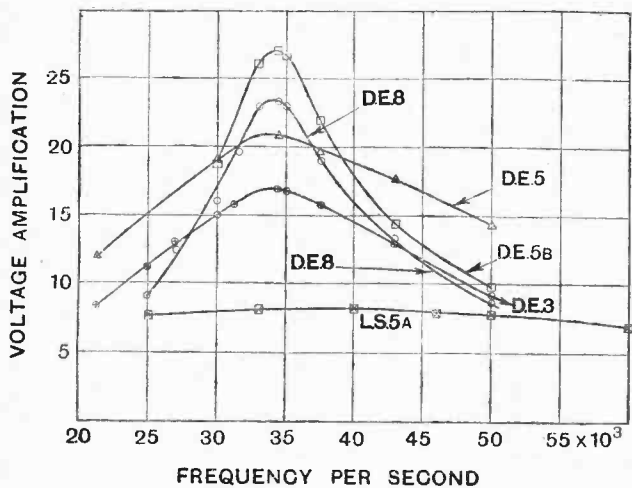

Fig. 8.—Amplification curves for No. 2 transformer.

clearly show how erroneous any calculations would be if the average values specified on the instruction sheets supplied with the valves, excepting, perhaps, the D.E.5 and L.S.5A., had been used. In any case, the filament brightness, etc., play a vital part in the amplification curves, and it does not follow that a valve chosen at

<sup>2</sup> The impedance of the transformer at resonance can be found to a first approximation, from which the effective step can be computed.

random will always be a good one. It was for these reasons that the actual "m" and  $\rho$  values were ascertained for each valve used. The values of  $\rho/m$  for each valve were found using different transformers, and there was a good agreement in general

**Discussion of Results.**

(1) *Amplification Curves.*—The amplification curves for each of the four transformers under test are given in Figs. 7, 8, 9, and 10. The general effect of a low resistance valve is to give a flat-topped amplification curve, whilst a high resistance valve (D.E.8 or D.E.5B.) is accompanied by a decided peak. These effects are quite in accordance with theoretical considerations, as explained in another section of this article. To put the performance of the various valves and transformers on a comparative basis, the data of Table II have been compiled.

TABLE II.  
SHOWING MAGNIFICATION AND STEP AT OPTIMUM WAVELENGTH.

Transformer.	Maximum Amplification, H.T. Voltage and Valve Used.					Ratio of Turns.
	60v. L.S.5A.	60v. D.E.5.	60v. D.E.3.	80v. D.E.8 H.F.	80v. D.E.5B.	
1	6.3	16.0	13.3	18.4	21.4	3.0
2	8.2	20.8	17.0	23.3	27.0	4.0
3	9.7	27.0	23.3	47.0	54.0	4.4
American	9.3	16.4	13.2	13.3	16.0	4.0
Actual Transformer Step.						
1	2.86	2.6	2.5	1.6	1.6	3.0
2	3.72	3.4	3.2	2.0	2.0	4.0
3	4.4	4.4	4.4	4.9	4.0	4.4
American	4.2	2.7	2.5	1.2	1.2	4.0

The efficiency of the transformer as a stepping up apparatus can be seen at a glance from the lower portion of Table II. With valves of low internal resistance the step approaches closely the turns ratio, but it falls off considerably with a high resistance valve, excepting in the case of the 4.4 : 1 transformer, which had a high inductance [about 10 times that of Nos. 1 and 2]. The ratio  $\frac{\text{step}}{\text{turns ratio}}$  is a useful guide to the efficacy of the transformer. For instance, with a D.E.8 H.F. valve the ratio for the 3 : 1 and 4 : 1 transformers are respectively 0.57 and 0.5. With the 4.4 : 1 transformer the value of  $\frac{C_s}{L}$  is much less than for the others. Hence the above ratio for this transformer is always high, and with a D.E.8 H.F. has a value of 0.9.

The above ratio can be written in the form

$$\frac{\text{Step}}{\text{Turns ratio}} = \frac{1}{1 + \frac{\rho C_s r_e}{L_1}}$$

If we assume that  $C_s = S^2 C$ , where S = turns ratio and C = equivalent secondary capacity,  $r_e$  is proportional to  $f^2$ , and  $L_1$  is constant, it can be shown that the preceding expression is independent of the wavelength. Thus, if the turns ratio were made 2 : 1 or 5 : 1, the above expression would be invariable, provided the primary winding were unaltered. This holds good within the wavelength limits in the present case, and here we have

**Supersonic Transformers.—Part II.—**

a nucleus for design. This means that if the amplification with a D.E.3 valve and a 3:1 transformer were 13.3 [above ratio  $\frac{2.5}{3}$ ], that with a 2/1 would be  $2/3 \times 13.3 = 9$ , with a 4/1 =  $4/3 \times 13.3 = 17.7$ , and with a 5/1 = 22. As a testimony to one of these results, it may

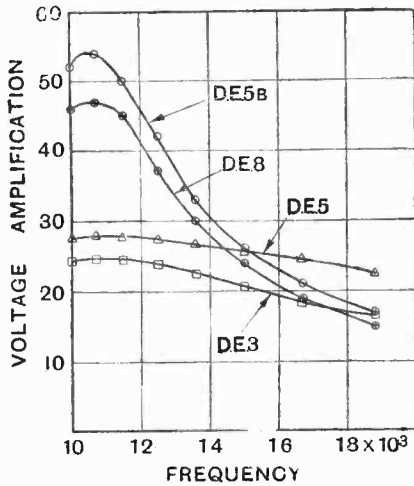

Fig. 9.—Amplification curves for No. 3 transformer. The H.T. for the D.E.3 and D.E.5 was more than 60v. (about 70).

be stated that the experimental value for the 4:1 was 17, i.e., a discrepancy of only 4 per cent.

It should be observed that the optimum wavelength increases with the turns ratio: also the amplification curve will be flatter the smaller the ratio, owing to the shorter wavelength and the reduced capacity.

The American transformer is rather feeble except with the L.S.5A valve, when it gives more than the step. This is due to leakage resonance, and has been explained already in connection with audio-frequency transformers.<sup>3</sup> In the American transformer the leakage is very large and the coupling between primary and secondary relatively small. It will be seen from the curves of Fig. 10

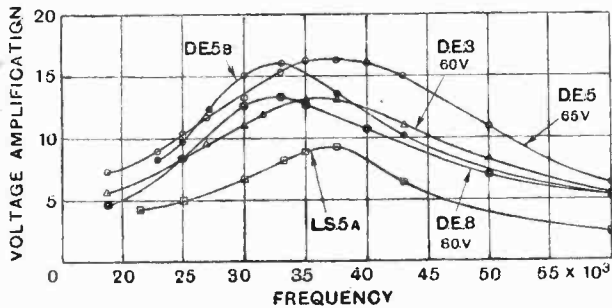

Fig. 10.—Amplification curves for American transformer.

that the optimum wavelength varies with the internal resistance of the valve. It is greater with high- than with low-resistance valves. This is in agreement with theory, for a high-resistance valve flattens out the leakage

resonance and leaves the major or first resonance; whereas with a low-resistance valve the leakage resonance predominates, as it also does with audio-frequency transformers. In order to ascertain whether the leakage resonance showed up in the other transformers, measurements were made with an L.S.5A valve (low resistance) at short wavelengths, but there was no perceptible hump in the curve.

(2) *Valve Coefficients.*—The various valve coefficients were obtained by the methods already described, using several transformers with each valve. The results of these tests are given in Table III.

TABLE III.  
MEASURED VALVE COEFFICIENTS.

Valve.	H.T. Volts.	Grid Bias.	$\rho/m$ .	$m$ .	$\rho$ (ohms).
L.S.5A	60	-1.5	$1.2 \times 10^3$	2.2	$2.6 \times 10^3$
D.E.5	60	-1.5	$1.2 \times 10^3$	6.1	$7.6 \times 10^3$
D.E.3	60	-1.5	$1.9 \times 10^3$	5.3	$10^4$
D.E.8 H.F.	80	-1.5	$2.8 \times 10^3$	11.5	$3.2 \times 10^3$
D.E.5B	80	-1.5	$2.4 \times 10^3$	13.5	$3.2 \times 10^4$

It is advisable to state that the points obtained with each transformer, using different shunting resistances for the determination of the coefficients, invariably lay on a straight line. Also, there was a close agreement between the values of  $\rho/m$  for any particular valve, as found with different transformers.

(3) *Comparison of Theory and Practice.*—In order to ascertain whether the theory put forward earlier

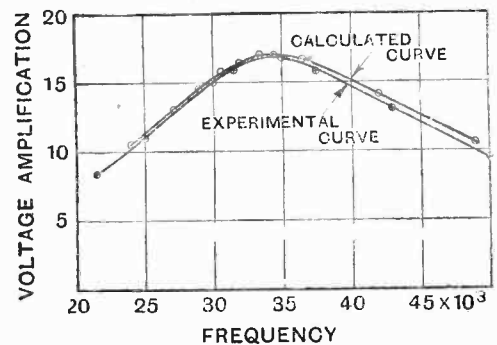

Fig. 11.—Experimental and calculated curves for No. 2 transformer with D.E.3 valve.

in the article was supported by experimental observations, a complete curve was calculated for transformer No. 2 with a D.E.3 valve (see Fig. 11). The agreement between the two curves is quite satisfactory, and shows that in this case, at any rate, the results form a fairly reliable basis for design. It should be pointed out that a good deal hangs upon the accuracy with which the optimum wavelength and the effective primary capacity are measured. From these two, the inductance is computed, and subse-

quently the effective resistance  $r_e$ . Now the ratio  $\frac{C_s r_e}{I_{s1}}$  is important, and it should be clear why  $C_s$  requires accurate determination, for an error of 1 per cent. in  $C_s$  means an error of 2 per cent. in  $\frac{C_s r_e}{I_{s1}}$ . Also  $r_e$  is calculated from

<sup>3</sup> "Speech Amplifier Design," *The Wireless World*, January 27th, 1926.



**Supersonic Transformers.—Part II.—**

the formula  $r_e = y \frac{L_1}{C_s \rho}$ , where  $y$  is found experimentally from the observed amplification. Thus  $y$  and  $\rho$  require careful measurement, so that  $r_e$  is obtained with sufficient accuracy for computing the amplification curve. It will be understood, of course, that the value of "m" is the same for both theory and experiment, and has no effect upon the agreement between the two.

(4) *Condenser across Primary.*—The effect of a condenser in parallel with the primary winding is to increase the optimum wavelength and to reduce the flatness of the curve. If the condenser is not too large, the effect is not serious. Curves have not been given for this case, since they would not serve any particularly useful purpose. A somewhat analagous case is depicted in Fig. 12, where the same transformer is used with two different

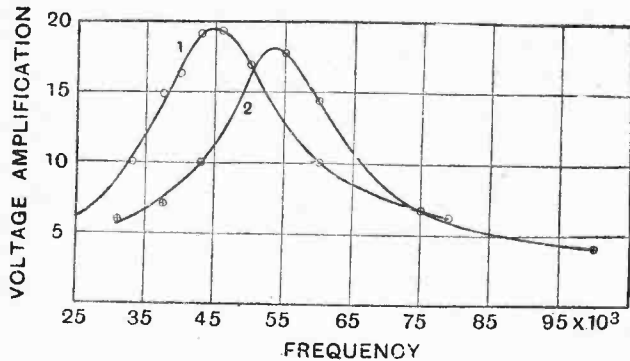

Fig. 12.—Amplification curves with D.E.8 H.F. for No. 1 transformer (2) polarised by H.T. and (1) after A.C. treatment at 300 cycles.

values of primary inductance.<sup>4</sup> The capacity is the same in both cases, but the value of  $\frac{C_s}{L_1}$  is different. This is roughly equivalent to keeping  $L_1$  constant and increasing  $C_s$ .

A point of interest, however, was observed in the measurement of the effective primary capacity, for the addition of 300 micro-microfarads to the 4 : 1 transformer not only increased the optimum wavelength, but augmented the amplification by 4 per cent. This was probably due to an increase in the differential permeability at the longer wavelength (lower frequency with smaller eddy currents).

It is clearly possible to match transformers by the aid of primary condensers, e.g., a 3 : 1 and a 4 : 1 with identical primaries could be matched by using a condenser on the 3 : 1. If desired, this expedient could be adopted to by-pass the H.F. in the detector valve, but great care would have to be taken that with a valve of high internal resistance, the side frequencies were not attenuated too much.

(5) *Comparison of 1.5 mil iron Transformer with American Supersonic Transformer.*—In the introduction to Part I we pointed out that results similar to those

<sup>4</sup> The turns were unaltered, but the permeability of the iron was different, due to heavy polarisation by H.T. battery. The larger inductance means a flatter top, and in this respect an increase in  $L_1$  acts oppositely to an increase in  $C_s$ .

secured by the use of 1.5 mil iron could be obtained by an alternative mode of construction. The details of such a transformer are shown in Fig. 13. The primary consists of a flat coil wound with enamelled wire, layer upon layer, interleaved by waxed paper. The secondary consists of two

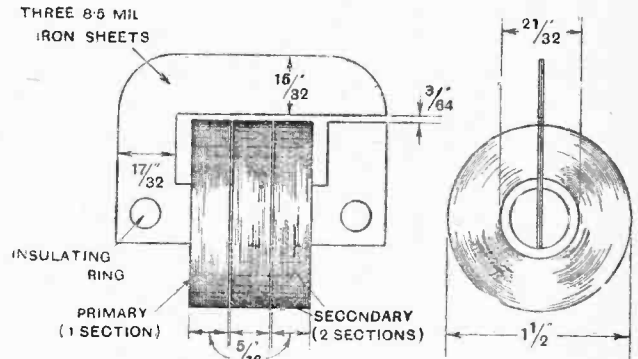

Fig. 13.—Constructional details of American supersonic transformer. The complete transformer is screened by a die-cast iron case filled with wax.

similar units side by side, the wire being of smaller dimensions than that for the primary. It is a difficult matter to ascertain accurately the number of turns on the two windings from geometrical measurements. From approximate electrical measurements the inductance of a secondary section is about 3.6 times that of a primary section, and it follows that the turn ratio is of the order 4 : 1. The primary and secondary sections are not interleaved, being merely situated side by side. Three pieces of special nickel-chrome steel, each 8.5 mils in thickness, and with an air gap of 50 mils, are threaded through the three sections. The object of this core is to increase the coupling and the effective resistance, thus giving a flatter top to the amplification curve. Even with the iron in

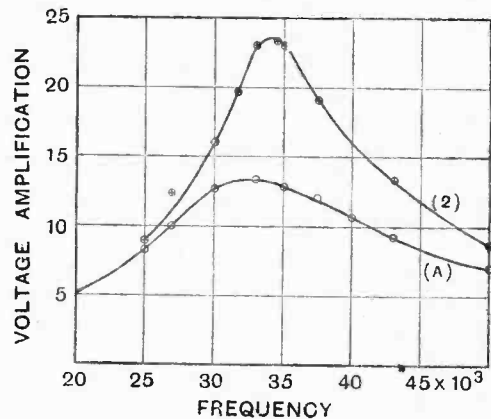

Fig. 14.—Comparison of amplification curves with D.E.8 H.F. valve, of No. 2 transformer with 1.5 mil iron (2), and American transformer (A)

place the leakage is about 80 per cent., or about 20 times that of the 1.5 mil transformer. The three sections and the core are situated in a nickelled iron case, the whole thing being made solid by running in a mixture of bees-wax and paraffin wax. The iron case serves as a screen and is very useful

Supersonic Transformers.—Part II.—

Suppose we remove the iron and consider the case of a transformer with air core coils. With the primary loosely coupled to the secondary, the magnification curve will resemble closely the tuning curve of the primary in the valve circuit (since the wavelength of the secondary is several times that of the primary, and it will have no influence). This tuning curve depends upon (a) the internal resistance of the valve, (b) the effective resistance of the coil, (c) the capacity of the coil. A high resistance and a large capacity mean a sharp curve, whilst a high effective coil resistance is accompanied by the opposite effect.

Thus a low resistance valve, high resistance coil, and low capacity mean a fairly flat top, with an optimum corresponding to the natural wavelength of the primary winding alone. In the present case the resistance is tolerably high, so that a flat top may be expected. Now let us bring the secondary winding near. The effective resistance of the primary is augmented, due to the energy passed on to the secondary, whilst the curve has now two humps. One hump occurs at a wavelength shorter than that of the primary, whilst the other occurs at a wavelength longer than that of the secondary. This double hump is very well known as a property of two closely coupled circuits. When the coupling approaches unity the lower

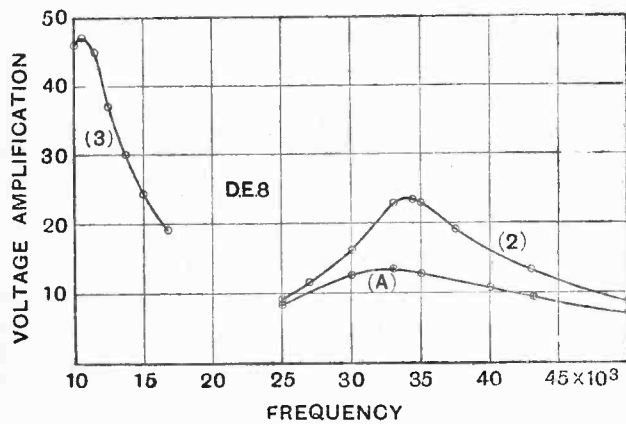

Fig. 15.—Comparison of amplification curves of No. 2 transformer (2), No. 3 transformer (3), and the American transformer (A).

hump approaches zero wavelength, i.e., infinite frequency, or in plain words it disappears for all practical purposes, so that we are left with only one hump. This is exemplified in the 1.5 mil. iron transformers, which have a resonance at a higher frequency—about five to eight times the optimum—but it does not show up on the curve. In the American transformer a close coupling is physically impossible, so that with an air core there are two humps. The insertion of the iron (1) augments the natural wavelength of both windings, (2) increases the coupling, (3) increases the effective resistance. The net result of (1) is a bodily movement of the whole curve to a lower wavelength. The effect of (2) is to drive the humps farther apart, and of (3) to flatten the top so that the contour is gently rounded. Clearly, the large resistance and the relatively loose coupling are conducive to a reduced secondary voltage. In other words, the step of the trans-

former is less than the ratio of the turns. Curves with valves of different resistance are given in Fig. 10, and it will be seen that, although the magnification is less than that with the 1.5 mil iron transformers the tops of the curves are flatter. This has advantages at times and disadvantages at others. The sharper peaks aid selectivity, and by the use of a valve of lower resistance they can be flattened out. There is little chance of super-selectivity in the American transformer, for the resistance is so high. Curves of the American and 1.5 mil 4:1 transformers are given in Fig. 14, whilst in Fig. 15 three comparative curves are given, although that of transformer No. 3 is somewhat out of the frequency range. It should be observed that with a valve of high internal resistance the longer the optimum wavelength the narrower the top of the curve, i.e., the smaller the band of side frequencies over which uniform amplification can be expected.<sup>5</sup> This sets a limit to the optimum wavelength, so that a reasonable upper audio-frequency range is preserved. Moreover, there are limits at each extremity of the optimum wavelength scale. One has just been cited, the other is the short-wave limit imposed by increased resistance and decreased inductance, thereby necessitating reduced magnification, although with reduced capacity the curves are quite flat topped.

A useful comparison is given in Table IV, in which the primary effective resistances and the ratios of  $\frac{L_1}{r_e}$  are placed side by side. The wavelength of the two transformers is approximately 9,000 metres and the turns ratio is 4:1 in each case. These figures are a clear indication of the tremendous difference in design. The 4:1

TABLE IV. COMPARISON OF AMERICAN AND 1.5 MIL IRON TRANSFORMERS.

Transformer.	Magn. with D.E.8 H.F.	Primary Inductance $L_1$ (Microhenrs.).	Primary Effective Res. $r_e$ (Ohms).	$\frac{L_1}{r_e}$	Optimum* Wave-length (Metres).
No. 2	23.3	$2.3 \times 10^4$	580	$4 \times 10^{-3}$	9,000
American*	13.3	$5.0 \times 10^4$	7,000	$7 \times 10^{-3}$	

\* $C_s = 460$  microfarads, which is about half that for No. 2.

1.5 mil iron transformer has an  $\frac{L_1}{r_e}$  value 5.7 times that of the American, which gives it superiority in the way of magnification. If its  $\frac{C_s}{L_1}$  value had been much lower the top of the curve would have been correspondingly flat. In this respect the American instrument has the advantage, for its  $\frac{C_s}{L_1}$  ratio is only about a quarter that of the 1.5 mil iron design.

<sup>5</sup> The flatness of the top measured in cycles on each side of the optimum frequency increases with the frequency. This point should be noted because one is so accustomed to reckoning the percentage variation from the optimum.

<sup>6</sup> This is the value given in the valve circuit with  $V_2$  operative. The true optimum is less.



By Our Special Correspondent.

**A Scottish Rumour—Geneva Questions—The Problem of Power—Broadcasting Abroad—Oscillators' Night—Communist Propaganda.**

**A Scottish "Daventry"?**

One of the latest rumours concerns the possibility of a Scottish "Daventry." One imaginative member of the B.B.C. staff (a Scot, by the way!) has been so smitten with the idea that he has been burning the midnight oil poring over a map of North Britain. The site he has chosen is—but I hate to give away secrets. Oh, well, the site is a hill near Perth.

If I have let the cat out of the bag it really doesn't matter, because, according to Savoy Hill, there will be no Scottish "Daventry."

o o o o

**The Silent Hebrides.**

"It would never do!" I was told. "If Scotland had a high-power station, Wales would want one, and Northern Ireland wouldn't stand that without a murmur."

So you see that, officially speaking, it is a question of diplomacy. Looking at the question from another angle, does Scotland need a high-power station? Up to the present there has been no public demand in this direction. There must be many places in the Hebrides where only a multi-valve set would pick up a broadcast programme—but the Hebrides have managed all these years without even a railway, so perhaps they can scrape along for a few more years without broadcasting.

o o o o

**The Parish Pump.**

One argument against the idea of two or three high-power stations covering Great Britain, to the exclusion of smaller stations, is that such a scheme would eliminate the local atmosphere in the transmissions.

Local pride would conceivably help Plymouth to bear things that would give Birmingham the earache, while Birmingham in its homely moments might cause Plymouth to "see red." The parish pump is still much beloved.

o o o o

**Harem Scare 'em.**

A Turkish musical play is to be broadcast on December 8 entitled "Ikbal—the Circassian Slave Girl." It will be a character study of a slave girl's life under the rule of the Red Sultan.

**Early to Bed.**

The latest grouse comes from a Wigan listener who upset his clocks last week through having mistaken the high flute notes in Strauss's "Alpine Symphony" for the ten o'clock time signal.

o o o o

**Who Is He?**

A "wireless pioneer" will be the organiser and announcer of "My Programme" on November 29.

o o o o

**Scots Wha Ha'e . . .**

On St. Andrew's Day, November 30, the Scottish stations will all contribute to a national programme, and, as this programme will be relayed to Daventry, English listeners will, in many cases for the first time, hear the music of the Aberdeen Police Pipe Band and Scottish choirs.

**A Broadcasting Questionnaire.**

Congratulations to the B.B.C. for issuing the very sensible questionnaire in the *Radio Times* on the subject of the Geneva scheme! The use of this form by listeners who report on the reception of European stations using the new wavelengths will save much time and trouble. It will anchor the imagination.

o o o o

**Why Experts Go Mad.**

Anybody who has ever been faced with the appalling task of answering listeners' letters and queries on unknown transmissions knows that they often take this form:—

"Dear Sir,—About 10 o'clock Sunday, or was it 9 o'clock on Saturday, I think I heard 'The Maiden's Prayer' on a wavelength of 453.5 metres. Of course, it might have been 'Valencia,' but I know that it was 455.3 metres because

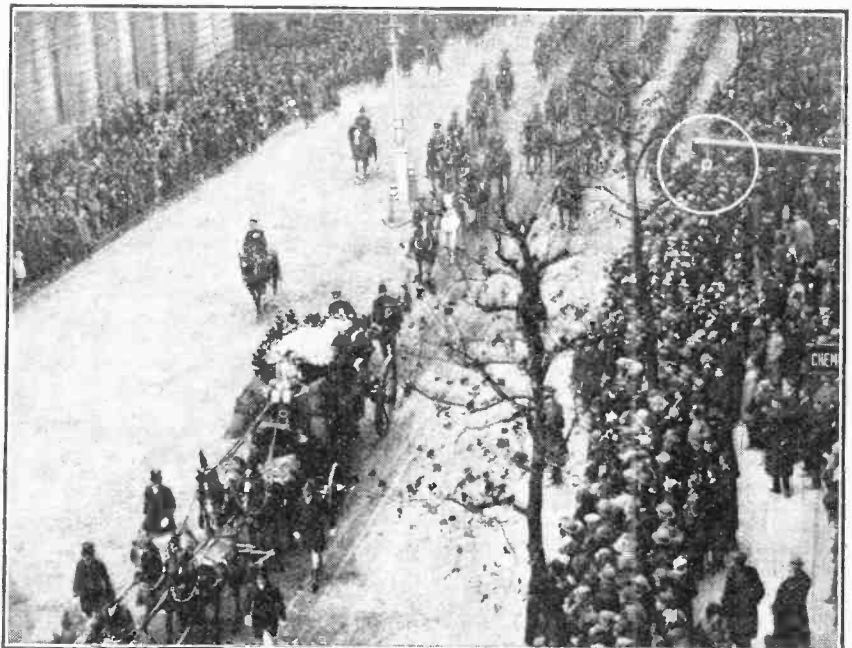

**A MICROPHONE AT THE SHOW.** Thousands of people who were unable to witness the Lord Mayor's Procession through London on November 9th listened via wireless to the noise of the crowd and a description of the pageant. The above photograph was taken in Northumberland Avenue. The microphone will be seen in the white circle.

I've a notch on my secondary condenser at 74 degrees which brings in Birmingham when I hold my hand close. Can you let me know by return if—"

Let us hope the questionnaire will save all this.

o o o o

**A Forgotten Problem?**

In preparing the new wavelength scheme, has Geneva taken into account the question of power? I do not think so. The present distribution of wavelengths may be admirable while power is restricted, but the general tendency is towards higher power. Stations which do not affect each other when using a kilowatt each may become very unpleasant neighbours when mounting to 5 kilowatts. Radio Toulouse, I hear, will increase its power to 5 kilowatts very shortly.

o o o o

**Keeping Pace with the Foreigner.**

Last week a question was raised at Westminster regarding the opportunities available to the Post Office for studying foreign broadcasting methods. This reminds one that the B.B.C. is denied facilities of this kind. The Broadcasting Company has neither the staff nor the income to depute officials to gather information concerning developments abroad, and as time goes on broadcasting in this country may suffer accordingly.

In the case of Government Departments special grants are always made for the purpose of keeping a careful watch on foreign progress. Will the new Corporation ensure the same facilities for British broadcasting?

o o o o

**From an American Broadcast Programme.**

"'Old Timers' Concert.' The tenor sings, 'What's the Matter with Father?' Probably no such program would be complete without the base solo "Asleep in the Deep."

He'd be asleep, anyway!

o o o o

**Wireless for the Blind.**

The Danzig G.P.O. has decided to remit the monthly 2s. licence fee in the case of blind listeners-in and has also organised a fund to provide necessitous blind with radio. Boxes for voluntary contributions have been installed at the post offices and already over one hundred poor people have been presented with free sets.

o o o o

**Sir Thomas Beecham.**

The fulminations of Sir Thomas Beecham on the subject of broadcasting are referred to on another page of this issue. In view of Sir Thomas' attitude a certain interest attaches to the news that the Glasgow Orpheans Choir has lost money on its six weeks' tour of America. Mr. Hugh Robertson, the conductor, who has just returned, said the American audiences were the most unpunctual he had ever encountered, and they have yet to learn the virtue of silence.

Sir Thomas Beecham states that the Americans are the most musical nation in the world!

**FUTURE FEATURES.**

**Sunday, November 21st.**

LONDON.—"Hassan."  
BIRMINGHAM.—Oratorio Gems.  
MANCHESTER.—Burnley Municipal Concert.

**Monday, November 22nd.**

LONDON.—St. Cecilia's Day Programme.  
BIRMINGHAM.—Ode on St. Cecilia's Day.  
CARDIFF.—"The Purse Strings"—Comedy by Bernard Parry.  
MANCHESTER.—"Fire," by A. J. Alan.  
GLASGOW.—Bach Society Concert relayed from Rankine Hall.  
BELFAST.—St. Cecilia's Day Programme.

**Tuesday, November 23rd.**

LONDON.—Co-Operator's Programme, from Kingsway Hall.  
BIRMINGHAM.—Military Band Programme.  
BOURNEMOUTH.—Coleridge-Taylor Programme.  
CARDIFF.—"5WA Visits Newport"—Concert relayed from the Central Hall.  
MANCHESTER.—Chamber Music.  
GLASGOW.—"The Guinea Stamp," by C. Stewart Black.  
ABERDEEN.—"The Heart of a Clown," by Aberdeen Radio Players.  
BELFAST.—Shakespearean Programme.

**Wednesday, November 24th.**

LONDON.—Variety.  
BIRMINGHAM.—Community Singing Concert.  
MANCHESTER.—Annual Scottish Concert.  
NEWCASTLE.—"The Blue Penguin"—London Radio Rep. Players.  
ABERDEEN.—Community Singing relayed from Cowdray Hall.  
BELFAST.—Royal Ulster Constabulary Band.

**Thursday, November 25th.**

LONDON.—B.B.C. National Concert relayed from Albert Hall.

**Friday, November 26th.**

LONDON.—Military Band Programme.  
BOURNEMOUTH.—Operatic Concert.  
CARDIFF.—Musical Comedy Programme.  
MANCHESTER.—"The Lily of Killarney."  
ABERDEEN.—"What is It?"—Seventh of a series of thumbnail sketches.

**Saturday, November 27th.**

LONDON.—"My Programme."  
BIRMINGHAM.—Revue.  
MANCHESTER.—Concert arranged by Editor of the "Manchester Evening News."  
NEWCASTLE.—Recital by Joseph Farrington (bass).

**Dancing all the Evening.**

At the request of many listeners, it has been decided to revive on December 4 the custom of providing an entire evening of dance music from the Glasgow station.

o o o o

**For Birmingham Listeners.**

All Birmingham listeners who have the time to spare are invited to the community singing concert which will be conducted by Joseph Lewis on November 24 at the Birmingham Midland Institute. Mr. Lewis is the musical director of the Birmingham station.

o o o o

**Oscillators' Night.**

A fortnight ago I took the liberty of reminding readers that Saturday is "Oscillators' Night." On these nights the B.B.C. stations make a point of "naming" districts where oscillation is severe. 5XX holds the record for the number of districts it has called to order in this fashion; the other evening Daventry's list amounted to 30! In each case, of course, a petition of complaint had been signed by six householders.

During the last week or two there has been an appreciable falling off in the number of complaints received, but whether this is due to the efficacy of the B.B.C. warnings, or to public "fed-up-ness," or even to a general realisation that the B.B.C. can do little to help matters, who can say?

o o o o

**A Grossmith Programme.**

Mr. George Grossmith is organising and will act as announcer for the seventh of the series which is being broadcast under the title of "My Programme," on December 11.

o o o o

**Community Singing.**

Community singing from the Albert Hall will be broadcast on November 20, when the soloist will be Mr. John Goss. The items are "What shall we do with a drunken sailor?" and "Shenandoah." Mr. Norman Allin will sing "When a maiden takes your fancy," "See the way you rogues come prying," and "Arise, ye subterranean winds."

o o o o

**Communist Propaganda.**

Communist doctrines appear to be "in the air" in more than one sense. Recent reports go to show that several British listeners have picked up propaganda talks of a Communist flavour on a wavelength of over 1,000 metres. The Director of the Hilversum Station, which was first suspected, strongly repudiates the allegation that his station is responsible.

The B.B.C. has received an interesting contribution to the discussion from an Estonian correspondent, who states that the transmissions in question emanate from the Leningrad station, which employs a power of 12 kW. The writer adds that in Estonia the Daventry transmissions are heard more clearly and at greater volume than those from any other station with the exception of Russian stations.



Notes on its Operation.

(Concluded from page 596, November 3rd issue.)

By W. JAMES.

IN the first part of this article we described the construction of the receiver, and it is now necessary to refer to the valves to be used and the method of operating the set. For the high-frequency and detector positions high-impedance valves are required, and for the output stage it is advisable to employ a valve of low A.C. resistance. A very satisfactory valve for the H.F. position is the Cosmos SP55 Blue Spot, which takes a filament current of about 0.1 ampere at 6 volts. This valve can be used with an anode voltage of 120 to 160, the A.C. resistance falling as the voltage is increased. The high-frequency amplification obtained will be a maximum when the higher voltage is used, but results are quite satisfactory if the anode voltage is 120. Selectivity will be better than when a voltage of 160 is applied. Other suitable valves are the DE5B, PM5A, and valves of this class having an amplification factor of about 20 and an A.C. resistance of the order of 30,000 ohms.

In the 2-volt series of valves will be found many which

are suitable, but it should be borne in mind, when choosing a valve, that one having an A.C. resistance of about 30,000 ohms, with the highest amplification factor, is desirable. If the A.C. resistance of the valve is much less than 30,000 ohms the selectivity will not be so good. On the other hand, the higher the amplification factor—other things being equal—the more the amplification actually obtained. For instance, consider two valves, one having an A.C. resistance of 30,000 ohms and an amplification factor of 20, and the second an A.C. resistance of 15,000 ohms and an amplification factor of 10. When the first valve is used the selectivity and amplification will be very good, but when the second valve is used the selectivity will be poor in comparison, and the amplification will be nearly halved.

In the detector stage a DE5B, PM5, or PM5A valve should be used, or a Cosmos SP55 Blue Spot can be used, but it is not advisable to have one of these valves as H.F. and detector, as experience indicates that it is difficult to

prevent noise. In the 2-volt series of valves are many which are suitable for the detector position: there are the Cosmos Point One, the PM1 H.F., the DE2 H.F., and many others of approximately similar characteristics. For the output stage a DE5, PM6, B4, or other valve having an amplification factor of about 7 and an A.C. resistance of less than 10,000 ohms can be used.

A valve of extra low impedance, such as the DE5A, can be used when the loud-speaker employed is of modern design, for then the best possible quality of reproduction will be obtained. Of the 2-volt

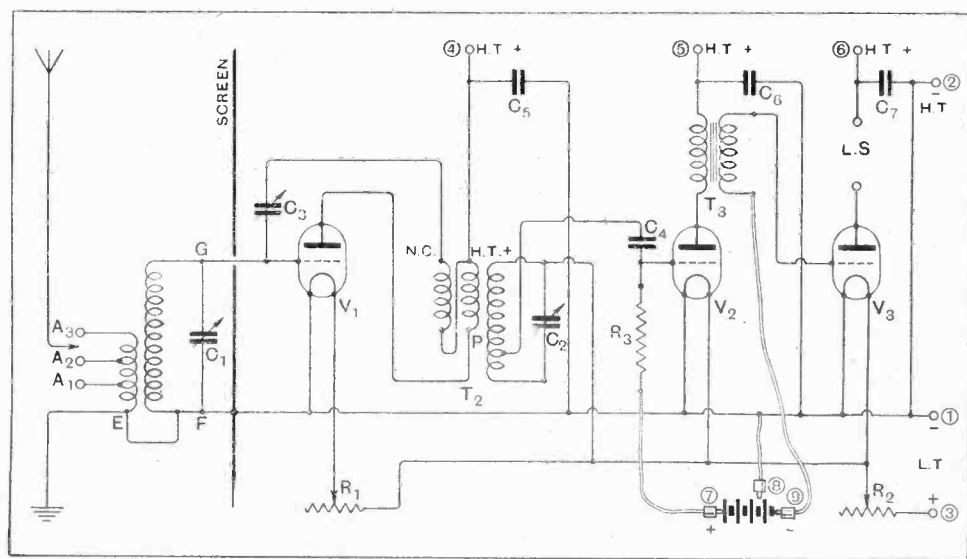

FIG. 1.—The circuit diagram of the receiver.



**Everyman's Three-valve Receiver.—**

valves the Cossor Stentor Two, PM<sub>2</sub>, DE6, and others are suitable.

Turning now to the circuit diagram, it will be seen that the grid of the detector valve can be given a negative or positive bias by connecting the flexible wire marked 7 to an appropriate point on the grid battery. When 6-volt valves are used plug 7 should be connected to the positive terminal of the grid battery and plug 8 to negative 3 or 4.5 volts, thus making the return end of the grid leak positive 3 or 4.5 volts with respect to the negative side of the filaments. When 2-volt valves are used plug 8 should be connected to negative 1.5 volts. The position of plug 9 determines the grid bias of the power valve and obviously will depend on the type of valve used at V<sub>1</sub>. It is important to note that the grid bias applied is equal to the voltage between plugs 8 and 9 and not between plugs 7 and 9.

It is possible to use the detector as the anode rectifier by connecting plug 7 to a point negative with respect to plug 8, but when a high-impedance valve is used as the detector the quality will not be so good when anode rectification is used, owing to the high impedance.

To balance the receiver the local station is tuned in, the first valve turned out by means of rheostat R<sub>1</sub>, and the balancing condenser is turned until the local station cannot be heard. The balancing condenser is mounted on the front panel, in order that a slight reaction effect may

be obtained when receiving a normally weak signal. This condenser should be adjusted very carefully; if it is turned haphazardly it will in all probability be found that the set oscillates violently.

The amount of high-frequency voltage amplification, viz., about 200, is obtained with the receiver in a perfectly stable condition, and takes into account the voltage step-up of the aerial-grid transformer, the H.F. valve and transformer, and also a small amount due to reaction. The amplification of the H.F. valve and transformer alone amounts to about 30, instead of the usual 40, because of the detector tapping. If the set is critically adjusted by setting the balancing condenser at such a point that the set is nearly oscillating, the amplification of a weak signal is much more than 200; but it is not intended that the receiver should be used in this condition, as it is the aerial-grid transformer which is affected, although the range and selectivity can, of course, be considerably increased by the intelligent use of this condenser.

It should be mentioned that it is necessary to adhere to the construction described; in particular it is not safe to alter the design of the H.F. transformers. The Litz wire used must be of the best quality and have 27 strands of No. 42; a cable having a different gauge of wire and number of strands will spoil the results—in fact, certain sizes of Litz wire have been shown to be inferior to solid copper wire under the conditions in which it is used in this receiver.

**An Old Stager.**

"The smallest receiving set in the world"—in a matchbox—made its reappearance at the Bristol and District Society's meeting on November 5th. Its constructor was Mr. W. A. Andrews, who also exhibited a portable super-heterodyne by way of variety! The occasion was a demonstration of home-built apparatus, other exhibitors being Mr. J. Rattle, with a loud-speaker control unit; Mr. R. Dinham, with a five-valve set; and Mr. J. R. Houghton, who showed a single-valve short-wave receiver.

A number of commercial parts were also on show, including a radio-set alarm clock, for switching on and off at any desired time.

Hon. secretary: Mr. S. J. Hurley, 46, Cotswold Road, Bedminster, Bristol.

**Audience of Two Hundred.**

The Preston and District Radio Research Society is in the fortunate position of having booked at least one lecture or demonstration every week from now until the middle of February. Various manufacturers have undertaken to provide lecturers, principally because the Society can guarantee an audience of at least 200.

On October 25th Mr. Pearson, Director of the Liverpool Broadcasting Station, gave an interesting talk on "Broadcasting in Great Britain," and was followed by Mr. C. C. Breakell (2KS), whose demonstration was entitled "Perfect Reproduction."

Full particulars of membership (entrance fee, 2s. 6d.; subscription, 5s. per annum) can be obtained from the Hon. secretary, Mr. John B. Cookson (2BDA), 14, Lune Street, Preston.

NEWS FROM  
THE CLUBS.

**The Story of the Condenser.**

Not many of those who enjoy wireless reception by the fireside would connect their pleasure with the hard toil of Indian men and women some thousands of miles away in the Indian jungle. This fact, however, was brought home to members of the Ipswich and District Radio Society on November 1st, when a fair number of them listened to a lecture, illustrated with lantern slides, given by Mr. D. Hayward, of the Dubilier Co.

One learned that the small fixed condenser was built up principally of tinfoil and mica. Of this latter mineral there are numerous varieties, but only that known as "ruby mica," hewn from the mines situated in the Bengal jungle, can be used satisfactorily in condensers.

After following the mica through its various stages until it arrived at the English factory, the audience viewed the assembly of all types of Dubilier condensers, and saw them subjected to precise and accurate tests before being released for sale.

Hon. secretary: Mr. H. E. Earbrook, 22, Vernon Street, Ipswich.

FORTHCOMING EVENTS  
will be found on page 672.

**The "Super Het."**

"Supersonic Heterodyne Receivers" was the title of an instructive talk given recently to members of the Barnet and District Radio Society by Mr. W. K. Alford, of the Igranic Electric Co. Mr. Alford spoke of the evolution of the "super het," its characteristics and capabilities, and illustrated his remarks by demonstrating a six-valve "super het" receiver.

Hon. secretary: Mr. J. Nokes, "Sunnyside," Stapylton Road, Barnet.

o o o o

**A Wide Subject.**

If the subject of "Broadcast Amplification" has any bounds there was no evidence of it on October 27th, writes a correspondent who was present at the meeting of the North Middlesex Wireless Society on that date. The lecturer was Mr. J. H. A. Whitehouse, of the B.B.C., who not only expounded in agreeable fashion upon this fascinating subject, but elucidated many problems which puzzle the average experimenter.

Perhaps the most interesting points dealt with were the practical methods of determining the various characteristics of valves and transformers. Much information was given concerning the great care taken at 2LO and other stations to ensure that the modulated waves transmitted are as faithful a copy as possible of the sound waves produced in the studio. Mr. Whitehouse extended a cordial invitation to the members to visit 2LO and see the apparatus at work.

The hon. secretary of the club is Mr. H. A. Green, 100, Pellatt Grove, Wood Green, N. 22.

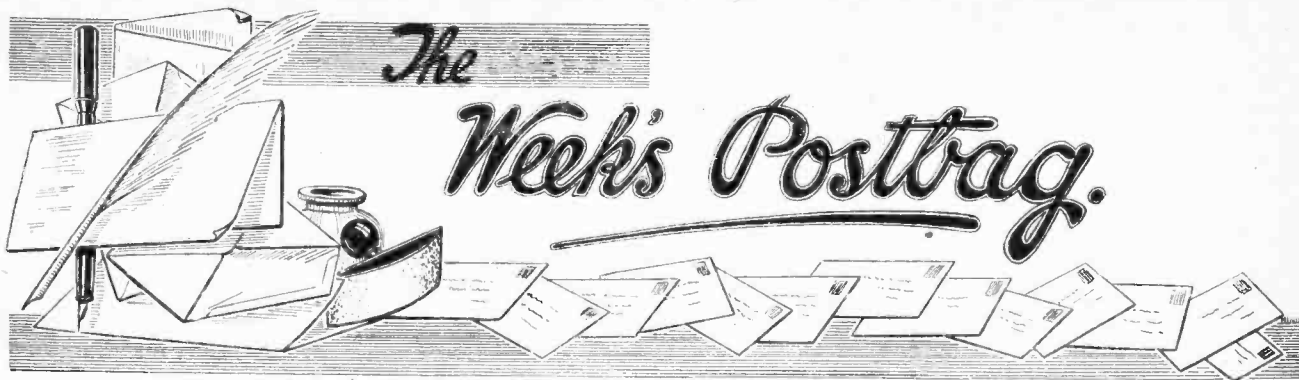

The Editor does not hold himself responsible for the opinions of his correspondents.

Correspondence should be addressed to the Editor, "The Wireless World," Dorset House, Tudor Street, E.C.4, and must be accompanied by the writer's name and address.

#### H.T. FROM A.C. MAINS.

Sir,—As one who has been experimenting with rectifiers (chemical) for the last year or so, may I say that one of the chief obstacles in the way of a more general adoption of these must be the high cost of suitable condensers for the smoothing circuits. It is all very well for Mr. Pragnell to lay down that all such condensers should stand at least four times the supply voltage, but condensers of this kind are either not available at all or they are sold only at what must be for most people a prohibitive price.

So far, the only condenser I have come across which is in any way "practical politics" is a 4 mfd condenser, apparently of foreign make. This will stand up all right to about 200 volts A.C. But after that it is apt to break down.

I find that four such condensers are required to give good results in a three valve set and if only 200 volts are required these foreign condensers serve well enough. It is, however, to be hoped that our own manufacturers will rise to the occasion and put something on the market which will be safe at higher voltages, for I am quite convinced that once anybody has run his H.T. off the mains, either with the fairly satisfactory aluminium rectifier or with the (to my mind) quite satisfactory tantalum rectifier, he is not in the least likely to return to H.T. batteries of any sort or kind. E. C. RICHARDSON.

West Byfleet.

October 21st, 1926.

#### AMERICAN RECEPTION.

Sir,—With regard to Mr. A. E. Duckett's enquiry *re* American short-wave transmissions, I would like to inform him and other newcomers to these programmes that I have received a letter from the General Electric Co., Schenectady, advising that 2XAF transmits WGY's programme on Tuesdays and Saturdays, and is usually continuous from 6 p.m. to midnight. Owing to the "developmental investigations" being carried on by them, it is impossible to keep distant listeners fully acquainted with all their short-wave transmissions, but on Saturdays at 6.45 p.m. E.S.T. the complete schedule for the ensuing week is broadcast from 2XAF (32.79 m.) by "ICW Telegraph."

This company welcomes reports from distant listeners, and anyone sending observations to the Engineer, WGY, 1, River Road, Schenectady, can rest assured of a very courteous reply. London, October 26th, 1926. F. G. PRATT (BRS39).

#### NATIONAL WIRELESS WEEK.

Sir,—It is with a soupçon of surprise that I see so many and varied parties boosting a "National Wireless Week." To me it seems a simple way, on the part of the manufacturers, of increasing their sales. Personally, considering the absolutely extortionate prices enforced for valves in particular, and all the rest of wireless paraphernalia in general, I should do my best to discourage any friend from taking up the so-called pastime. When one compares the values in this field and in that of motoring, one is forced to the conclusion that the best

way to increase the listening (perhaps blooping) public lies in the hands of the manufacturers, who have the example of the motor car makers and know its results. G. O. KERR.

Beckenham,

November 5th, 1926.

#### DEMONSTRATIONS BY MANUFACTURERS.

Sir,—As secretary of the Thornton Heath Radio Society, which claims to have the highest average attendance of any similar society in the country, I am writing to voice a protest on behalf of our members at the attitude adopted by some of the big manufacturing radio firms when asked to provide a lecturer or demonstration at our meetings. Some (and surely the wise ones) are very obliging and necessarily reap the benefits because we are all users of wireless components and are all keen to get the best. The least a firm can do is to acknowledge receipt of an application, but some of them do not even do this. A good demonstration or lecture is a splendid advertisement, and, after all, the cost is not very great, and societies like ours are a good channel for the manufacturers to use to get in touch with the people who can appreciate the value of a really good article. We should be sorry to assume that all the firms who have treated us discourteously are suppliers of "dud" components.

A. H. BANWELL.

Hon. Sec. Thornton Heath Radio Society.

November 6th, 1926.

#### IDENTIFYING BROADCAST TRANSMISSIONS.

Sir,—Referring to Mr. L. Williams' letter in the October 27th issue of *The Wireless World*, there would appear to be a small difficulty in picking out the abbreviated Morse figure, as when the station identification number contained figures 5 and 0 (abbreviated code E and T), one might easily lose the single dot or dash, especially when atmospheric conditions are present. I am sure that I am only one of hundreds who have congratulated Münster on his "M.S." call, and cannot help suggesting that the proper call-sign is the correct identification for broadcast stations.

However, following up the first idea, it would certainly appear to be far from difficult for Geneva to allocate numbers to all stations which come under the Bureau, but each number ought to consist of at least two figures, and be transmitted in full code, to avoid being misunderstood.

Exactly how relay stations will act will be interesting, when they occupy a common wavelength, and one can foresee the man with a powerful set getting his call-signs jumbled at the end of an item if he has unwittingly been receiving Nottingham and Stoke simultaneously, when they were both taking the London programme. A. CLARENCE BUSHELL.

South Merstham, October 27th, 1926.

NOTE.—Owing to pressure on our space further correspondence on this subject has been held over until next week's issue.—EDITOR.

Sir,—I have read with great interest your editorial in the October 27th issue of *The Wireless World* on identifying transmissions, and I heartily endorse your remarks on the subject.

By taking up this matter you are rendering a great service to the listening public. There is a great demand for some simple means of identifying transmissions, which is borne out by the frequent reference made to this problem in the Press. The first, and only, paper so far which has contributed anything towards a solution has been *The Wireless World*, when it published a letter to the Editor on this subject dated February 12th, 1926, giving a general outline of my solution (see *The Wireless World*, March 17th, 1926), a perusal of which will show that the main points of your Editorial and Mr. Williams' letter are fully covered.

Your suggestion to arrange stations in order of their wavelengths is, I think, an admirable one. While my scheme may not be the last word, it is, so far as I am aware, the first and only scheme to be put forward on international lines.

Going further into details of the example given, the figure 2 might be on one note and 3 on another, thus preventing any confusion with tens and units; the same suggestion could also apply to 100.

My system of identifying transmissions has been before the Radio Conference at Geneva for their consideration, and I herewith enclose a copy of the correspondence, which may be of value to your numerous readers when considering the problem.

In reply to my letter to Mr. Burrows of Oct. 23rd I have received a further communication from Geneva which indicates that the question of identification signs and interval signals is still exercising the minds of the European broadcasting companies, but that replies to a recent communique on the subject do not suggest a change of the previous attitude.

Personally, I do not think there will be great difficulty in obtaining a satisfactory solution: the real difficulty will be to rouse the authorities out of their apathy, and unless the listening public make a determined demand they are not likely to have their wishes attended to in this direction and matters will just drift on in the present unsatisfactory manner.

I await with interest the suggestions put forward by your readers.

Glasgow,

A. A. SCHASCHKE.

November 1st, 1926.

#### COPIES OF CORRESPONDENCE.

GENEVA,

October 2nd, 1926.

ARTHUR A. SCHASCHKE, ESQ.,

Dear Sir,— . . . The idea was submitted to each of our members throughout Europe, and, whilst the ingenuity of the proposal was generally appreciated, the great majority felt that much confusion would follow through persons not hearing the entire signals.

Also (although a somewhat similar practice has taken place at one of the European stations to-day) the members generally speaking were of the opinion that the introduction of non-musical signals would be against the artistic composition of a programme.

Yours sincerely,

(Signed) A. R. BURROWS,

Secretary,

General Union Internationale de Radiophonie.

GLASGOW,

October 23rd, 1926.

MR. BURROWS,

Geneva.

Dear Sir,—I beg to thank you for your letter of October 2nd in which you convey the Council's decision on my suggested scheme of international radio stations' call signs. Having discussed the points with several enthusiastic musical authorities, I regret the Council's decision, as I think it has been arrived at through a misapprehension of facts.

1st. Regarding the sound which the Council say would interfere with the artistic composition of the programme, there is no reason why a sound which would jar on the ear should be employed, as any harmonious note or notes can be used. 2nd. The non-receipt or partial receipt of signals is a debatable point, as it either means the listener's set is not capable of receiving satisfactorily anything from the station, or the listener has tuned in during the signal. It is therefore obvious the

listener would get it when the full signal is repeated. At present the B.B.C. are employing signals such as the tuning note and time signal which, to the average musical ear, are often a jar, but apparently the B.B.C. do not consider these signals inartistic. I cannot, however, understand any objection to a harmonious chord being employed for the purpose of a signal. The German gong, for instance, cannot be said to interfere with the musical or artistic composition of the programme. What is more confusing than the present method whereby one is left guessing if one has tuned in the call signal given in a foreign language?

I sincerely hope that the Council fully realise the great demand there is at present for some international call signal which will be simple and still so effective as to enable any listener to recognise at once the various stations at home or abroad. I would suggest, considering the importance of the subject from the listener's point of view, a competition be opened for the solution of this problem. In the meantime I am willing to demonstrate by arrangement my solution for a limited period free of all costs from SSC or any other station.

Awaiting your reply.

Yours faithfully,

(Signed) A. A. SCHASCHKE.

#### LICENCE FEES UNDER THE NEW AUTHORITY.

Sir,—It appears probable that when the new broadcasting authority takes over the work of the B.B.C. the public may find themselves committed to a scheme which is devoted to the mere maintenance of present broadcasting conditions.

The whole science and art of wireless is at present in its infancy. It is not improbable that in the near future the discovery of simple methods of selection, or of beam transmission, may render the existing broadcasting chain entirely obsolete. It is reasonable to imagine that television may be developed to a point where practical and commercial success is obtainable.

If it is the intention of the authorities to budget only for the *maintenance of the present station and programme policy* the service of education and amusement rightly expected by the public will be seriously restricted.

No other science has made so great an appeal to the public, and by no other means than radio is it possible to bring events and news home to the community with the speed which is now essential for utility.

Under existing conditions not only is a very large proportion of the fee payable by the licensees retained by the Post Office for purely nominal duties, but the actual expenditure upon stations and programmes is seriously limited.

It is estimated that by December 31st next the sum of approximately £900,000 will have been retained by the Post Office, when it is of the greatest importance that more than this amount should be spent for the benefit of the listener instead of being used by the Government for the relief of taxation.

The public is apparently to be left unacquainted with the manner in which their money is to be spent; they have already had an example of part of a fund definitely earmarked by the Government for road maintenance as the result of motor taxation being absorbed for totally different purposes.

The danger is much greater with radio, which in its embryo stage could never recover from initial starvation or restriction of its natural growth.

It is humiliating to find that in the case of listeners situated perhaps sixty miles from some of our stations it is more easy for them to tune in to German and other Continental stations than to contact with our own programmes.

The Wireless League claims that ample financial support should be available for the ever-widening possibilities of radio, and is demanding that nothing shall hamper the service which the listener has been rightly led to expect.

That the listener's money *should be spent on the listener before it is too late*, and that the listener should have a voice in the manner in which this money is spent, is patent to every-one interested in radio.

May I urge that licence holders should communicate with me at once in order that, as the listener's representative organisation, we may stand solidly together and get what we want.

A. M. LOW,

Hon. Technical Adviser and Secretary,  
The Wireless League.

London, S.W.1.

November 6th, 1926.

# READERS' PROBLEMS

"The Wireless World" Information Department Conducts a Free Service of Replies to Readers' Queries.

Questions should be concisely worded, and headed "Information Department." Each separate question must be accompanied by a stamped addressed envelope for postal reply.

### A Single-valve Loud-speaker Set.

I am desirous of building a receiver which will receive the local station (25 miles distant) on the loud-speaker, and will receive several other stations on the telephones. I am told that to accomplish my desire I shall need at least three valves, which is more than I really wanted to use. Your advice on this matter would be appreciated.

L. M. S.

Your requirements are very modest, and you do not need anything like three valves to accomplish your purpose, one being ample, and we suggest that your best course is to construct the single-valve loud-speaker receiver described with full constructional details in our issue of December 2nd, 1925. We reproduce the necessary circuit diagram in Fig. 1.

The aerial-grid transformer is wound on an ebonite former 5in. long by 3in. diameter, the secondary consisting of seventy turns of No. 20 D.C.C. The primary consists of twelve turns of the same wire wound over the "filament"

end of the secondary, it being held on "spacers" in the manner repeatedly described in this journal. The valve-crystal transformer is wound on a former 3in. long by 2½in. diameter. The secondary consists of sixty-five turns of No. 24 D.S.C. taped at the twentieth turn from the "filament" end for connection to crystal. The primary and neutralising windings are wound in the same manner as the primary of the other transformer, and consists of a continuous winding, there being twenty turns of No. 36 D.S.C. in each winding. The L.F. transformer can be of high ratio, such, for instance, as the Marconiphone 8 to 1 ratio type.

Provided that this receiver is carefully made, it should adequately meet your needs, and provided that a reasonably good aerial system is used it will be found that its loud-speaker range considerably exceeds the limit you specify. It is only when complications such as switching and an attempt to make the instrument cover all wavelengths are introduced that efficiency falls off and the receiver becomes scarcely worth the trouble of making.

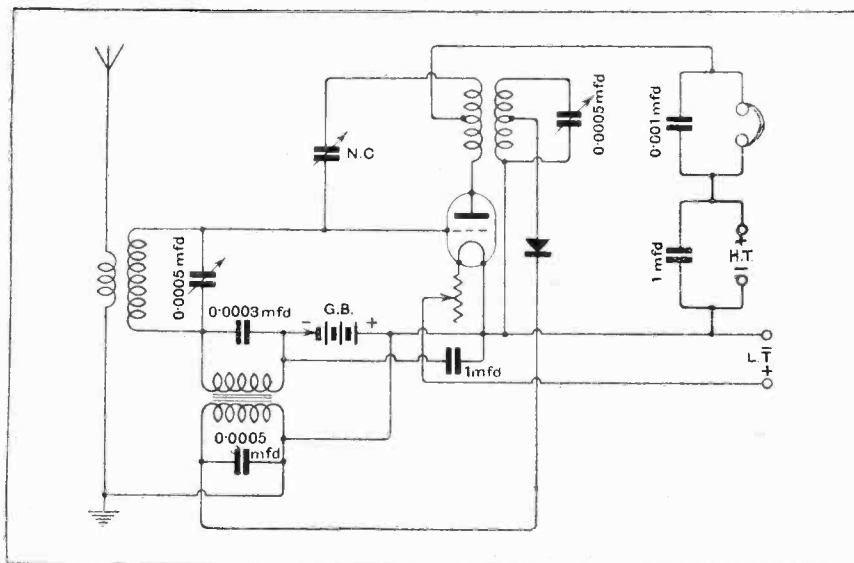

Fig. 1.—This single valve circuit will operate a loud speaker.

### Flash Lamp Fuses.

I have been told that the connection of a flash-light bulb in the common H.T.—lead would effectually safeguard the valve filaments in the event of the H.T. and L.T. leads coming in contact accidentally, since the bulb would act as a fuse. I followed this advice, but recently touched my H.T.+ and L.T.+ together, and both my valves, which are of the .06 amp. class, were burnt out, but the bulb still glows, which is very tantalising. Where have I gone wrong? F. M. P.

Most flash-light bulbs consume about 0.3 amps., although they vary a great deal, and many will take a current of half an ampere for a considerable time before they burn out. It will be seen, then, that the average flash-light bulb is of very little use for this purpose, especially with valves belonging to the 60 and 100 milliamperes classes. Used with the 0.25 ampere type of valve, the bulb would be of use, because it must be remembered that it is very seldom that one sees a valve of this type in a single valve set, and if two valves are used the total current flow would have to exceed half an ampere before the valves were overrun, and usually this type of valve is very robust, and will stand a certain amount of filament overloading without great harm, and it is probable, therefore, that in a receiver using not less than two valves the bulb would be burnt out long before the valves were damaged. Quite reliable fuses can now be obtained, however, which are guaranteed to melt under the influence of a certain current, and it would be preferable in any case to use these.

o o o o

### A Reversal Effect.

I have just completed a four-valve receiver, consisting of one stage of H.F., detector, and two L.F. stages. The two L.F. stages are both transformer coupled, and in both stages D.E.5 valves are used. I fitted jacks in the plate circuit of each valve for the purpose of plugging in a milliammeter. I find that on inserting my milliammeter in the plate circuit of the final valve, I get a reading of about six milliamperes. On placing the milliammeter in the plate circuit of the first L.F. valve, however, the needle registers zero, and yet the receiver appears to be functioning correctly. Why is this? G. D. M.

It is obvious from the symptoms which you mention that you have got the jack in the plate circuit of your first L.F. valve wired wrongly. The result is that the flow of current through the meter is in the wrong direction, and in all probability, if you watch your meter carefully, you will find that the needle moves slightly from the zero mark in the wrong direction until it is stopped by a check stud. If you reverse the connections of this jack you will find that all will be in order. Of course, the fact of this jack being wrongly connected will not make any difference to the performance of the set.

### C.W. Reception on Superheterodyne Receivers.

*Why is it that I am only able to receive C.W. stations on my superheterodyne when my intermediate amplifier is oscillating and then only those stations having a wavelength approximating to the wavelength of the amplifier? Surely I ought to be able to receive short wavelength C.W. stations when my frame aerial is tuned to this wavelength, since my first detector valve is in a continuous state of oscillation, it being a combined detector oscillator?*

D. B. A.

In order to receive C.W. stations on an ordinary receiver, it is well known that local oscillations must be generated which are slightly different in frequency from those set up in the tuned frame circuit by the incoming signals. An audible beat note is thus produced which can be heard in the telephones, and by varying the frequency of the local generated oscillations it is possible to alter the pitch of the received signals as desired. These local oscillations can either be generated by a separate valve specially employed for that purpose, or by causing the detector valve to oscillate. Since it is necessary that the oscillations generated be of slightly different frequency to the incoming oscillations, it will obviously be impossible to tune the receiver to the exact frequency of the incoming signal, as the locally generated oscillations will then be of the same frequency as those due to the incoming signals, and so no beat note will be produced. It is necessary, therefore, that in this case the receiver be detuned slightly.

Now in the case of a superheterodyne we again desire to generate local oscillations either by means of a separate valve or a common detector and oscillator valve to interact with the oscillations produced by the signals and form a beat frequency. In this case, however, it is specially arranged that the beat frequency is so high that it is above audibility. Hence the adjective "supersonic." It is clearly seen, therefore, that although the oscillations generated by your first valve do combine with the oscillations set up in the frame aerial by any incoming C.W. signals, the beat frequency which they produce is inaudible.

o o o o

### Vanishing Volts.

*I have built a two-valve receiver to give loud-speaker results on the local station only. I wish to install the receiver near the lead-in tube and to carry the L.T. wires to a switch in a downstairs room. Will this be in order?*

H. T. R.

You should under no circumstances carry your low-tension wiring to the switch, as long L.T. leads not only tend to act as a counterpoise, and so upset the normal tuning of the set, but, in the case of a large number of valves, the voltage drop along the extended wiring would be quite sufficient to reduce the temperature of the valve filaments below the operating point. Your best course is

to use a reliable relay, such as was used in the "Home Broadcast" receiver, described in our issue dated April 28th.

o o o o

### A Single-valve Regenerative Receiver.

*I wish to build a straightforward single-valve regenerative receiver using plug-in coils to cover both long and short wavelengths, my idea being the reception of a large number of stations on the telephones in the most efficient manner possible. I should be glad, therefore, if you will supply me with a suitable circuit.*

P. T. R.

We give in Fig. 2 a circuit which should meet your needs. In order to attain selectivity it will be necessary for

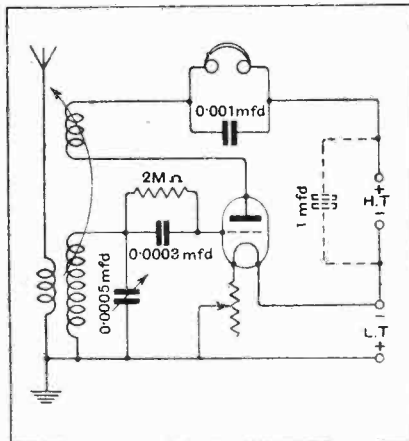

Fig. 2.—A simple regenerative circuit.

you to use a coupled aerial circuit, but you are advised not to use a three-way coil holder and a fully tuned aerial circuit, as it will be found that the receiver then becomes very difficult to operate. Far better results will be obtained by making use of the so-called "aperiodic"

## BOOKS FOR THE WIRELESS EXPERIMENTER

Issued in conjunction with "The Wireless World."

"THE AMATEUR'S BOOK OF WIRELESS CIRCUITS," by F. H. HAYNES. Price 3/6 net. By Post, 4/-

"TUNING COILS AND METHODS OF TUNING," by W. JAMES. Price 2/6 net. By Post, 2/10

"WIRELESS VALVE RECEIVERS AND CIRCUITS IN PRINCIPLE AND PRACTICE," by R. D. BANGAY and N. ASHBRIDGE, B.Sc. Price 2/6 net. By Post, 2/10.

"WIRELESS VALVE TRANSMITTERS—THE DESIGN AND OPERATION OF SMALL POWER APPARATUS," by W. JAMES. Price 9/- net. By Post 9/6

"DIRECTION AND POSITION FINDING IN WIRELESS," by R. KEEN, B.Eng. Price 9/- net. By Post 9/6.

"THE RADIO EXPERIMENTER'S HANDBOOK," Parts 1 & 2, by P. R. COURSEY, B.Sc. Price 3/6 net. By Post, 3/10.

Obtainable by post (remittance with order) from  
**ILIFFE & SONS LIMITED,**  
Dorset House, Tudor St., London, E.C.4,  
or of Booksellers and Bookstalls.

aerial coupling. The aerial and secondary coils should consist of two plug-in coils mounted side by side at a distance of about 1 1/2 in. in two fixed single coil holders, whilst on the other side of the secondary coil the reaction coils should be mounted in a moving single coil holder.

The coils may be of the commercial type, or home-made basket coils can be used if desired. On the normal broadcasting wavelengths the aerial coil may have about ten turns, the secondary fifty turns, and the reaction coil about thirty-five turns. On the Daventry wavelength the aerial coil can have 100 turns, the secondary 250 turns, and the reaction coil about 75 turns.

o o o o

### Attempting the Impossible.

*I am using a bottom bend rectifier, and find that for best results the value of grid bias is very critical, and the usual 1 1/2 volts grid battery tappings do not give me fine enough control. Can you inform me where I can obtain a battery with finer tappings than this?*

K. L. T.

It would, of course, be absolutely impossible to construct a grid battery with finer tappings than you have at present. The difference of potential existing between the poles of any dry or wet primary cell is approximately 1 1/2 volts, no matter how large or how small the cell. The size of the cell merely determines the maximum discharge rate, and the duration of the life of the cell. If we wish to build a battery of 6 volts we must make use of four cells in series. If, on the other hand, we wish to make a battery of 4, 5 or 7 volts, it cannot be done. Similarly, in the case of a secondary battery or accumulator the difference of potential existing between the two poles is roughly 2 volts, no matter what size the cells are made.

It will be seen, then, that we cannot make finer tappings in a grid battery than one tapping per cell, which gives us a tapping every 1.5 volts. If we require a voltage of, say, 1/2 volt, therefore, we must make use of a potentiometer connected across the filament leads to supplement the grid battery.

o o o o

### A Large Power Valve.

*I am building an L.F. amplifier with three stages for use in outdoor demonstration work. Will it be in order for me to use the same type of valve as in the other two L.F. stages, namely, one of 7,000 ohms impedance?*

C. E. W.

A valve of 7,000 ohms impedance would most certainly not have a sufficiently long straight portion of grid volts—anode current curve for use as output valve in your proposed amplifier, and a valve capable of handling a much larger grid swing should be used. Suggested valves are the Marconi L.S.5, D.E.5A or L.S.5A, the Mullard G.P. 425, the Cosmos S.P.55/Red Spot, or any valve of similar characteristics.



# The Wireless World

AND  
RADIO REVIEW  
(14<sup>th</sup> Year of Publication)

No. 378.

WEDNESDAY, NOVEMBER 24TH, 1926.

VOL. XIX. No. 21.

Assistant Editor:  
F. H. HAYNES.

Editor:  
HUGH S. POCKOCK.

Assistant Editor:  
W. JAMES.

Editorial Offices: 139-40, FLEET STREET, LONDON, E.C.4

Telephone: City 4011 (3 lines).

Advertising and Publishing Offices: DORSET HOUSE, TUDOR STREET, LONDON, E.C.4.

Telephone: City 2847 (13 lines).

Telegrams: "Ethaworld, Fleet, London."

COVENTRY: Hertford Street.

BIRMINGHAM: Guildhall Buildings, Navigation Street.

MANCHESTER: 199, Deansgate.

Telegrams: "Cyclist Coventry."  
Telephone: 5210 Coventry.

Telegrams: "Autopress, Birmingham."  
Telephone: 2970 and 2971 Midland.

Telegrams: "Hiffe, Manchester."  
Telephone: 8970 and 8971 City.

Subscription Rates: Home, 17s. 4d.; Canada, 17s. 4d.; other countries abroad, 19s. 6d. per annum.

As many of the circuits and apparatus described in these pages are covered by patents, readers are advised, before making use of them, to satisfy themselves that they would not be infringing patents.

## A MINISTRY OF BROADCASTING.



ALTHOUGH public opinion had been prepared for the terms under which the new Charter for the Broadcasting Corporation would be constituted for some time before the draft of the Charter actually became available, yet considerable surprise must be felt at the small response which members of the House of Commons gave to the opportunity provided by the Postmaster-General for a discussion on the new constitution of the service. Early last week in the House the Postmaster-General definitely invited views, but at the same time he discussed certain aspects of the new constitution in a way which no doubt anticipated certain criticisms from members. For example, the Postmaster-General stated clearly that it was not his intention to hamper or interfere with the work of the new body of governors, who would be left with a free hand except where the Government considered it necessary that general guiding principles should be laid down.

It is gratifying to know that advertising by means of the microphone is banned, and we sincerely hope that the new Corporation will interpret this limitation in the strictest sense, as this use of the microphone we have repeatedly urged should be expressly prohibited. Controversial matters, we note, are also banned including, of course, political speeches.

On the financial side, the Postmaster-General again appears to have anticipated criticism by making it clear

that the present basis on which the revenue will be allocated to the Broadcasting Service will be reviewed after a period of two years. Although the Service is to receive a considerably larger share of the licence fees than was granted to the B.B.C., yet in some quarters the feeling is still strong that the revenue is inadequate to meet the

expenses which are likely to be incurred in providing for alternative programmes, higher powered stations and a better news service. Throughout the debate in the House it was interesting to observe the importance with which the Broadcasting Service was regarded. As the Postmaster-General remarked, "Four years ago broadcasting was little more than a toy, whereas to-day it is a power. How great a power is not yet, perhaps, fully apprehended. It is a power not only national but international."

This brings us to the question of how long the Broadcasting Service will remain under the thumb, so to speak, of the Postmaster-General. Probably it will always be necessary for the Service to obtain its licence to operate the stations from the Postmaster-General, but it seems that at a comparatively early date all justification for the Postmaster-General

to have authority in other directions will have disappeared and, to judge by the ever-growing national importance of the Broadcasting Service, it seems to us highly probable that in the not far distant future the appointment of a Ministry of Broadcasting will be regarded as just as essential as other ministries which have been created to control various other activities of a national character.

### CONTENTS.

	PAGE
EDITORIAL VIEWS	693
COMBINED LOUD-SPEAKER RECEIVER	694
By A. P. Castellain.	
NEW WAVELENGTHS OF EUROPEAN STATIONS	700
PRACTICAL HINTS AND TIPS	701
CURRENT TOPICS	703
THE WIRELESS BEAM	705
PIONEERS OF WIRELESS (36)	709
By Ellison Hawks.	
NEWS FROM THE CLUBS	711
RECENT INVENTIONS	712
A NOTE ON DETECTOR-VALVE EFFICIENCY	713
SUPERSONIC TRANSFORMERS. PART III.	715
By N. W. McLachlan.	
BROADCAST BREVITIES	719
NEW APPARATUS	721
READERS' PROBLEMS	722

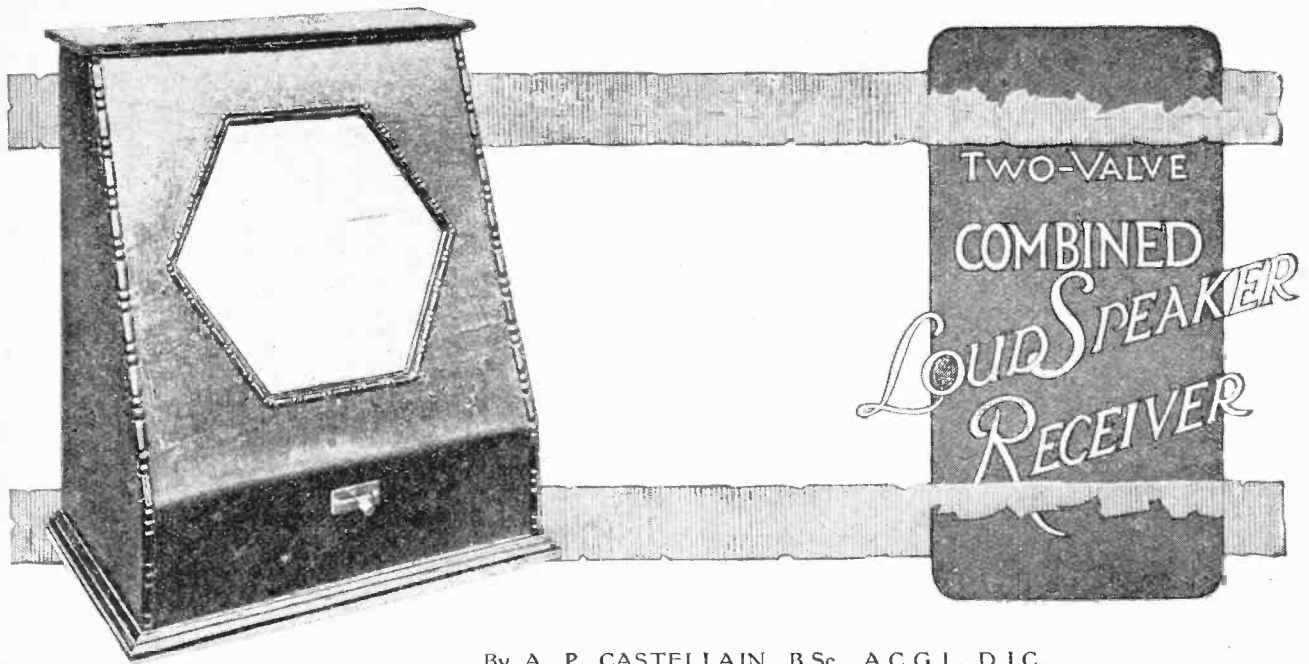

By A. P. CASTELLAIN, B.Sc., A.C.G.I., D.I.C.

### An Ideal Self-contained Instrument for the Local Station Listener, with Simple Switching Arrangement for the Daventry Wavelength.

THE set described in this article has been designed for the listener who wants to be sure of receiving the local station programme, and also Daventry occasionally—and not for the listener who likes to play with the knobs.

For this reason the set is made completely self-contained, with the exception of the low tension accumulator,

and the only visible control is a simple switch knob on the front, below the loud-speaker. This switch has three positions—one side giving the local station, the other giving Daventry, while the centre position is the off position.

The writer has never at any time been an admirer of the set with rows and rows of knobs to give every conceivable adjustment—that is all very well in its place for experimental work, but not to be incorporated in the final design, although it used to be a fashion among some people to judge the range and performance of a set by the number of knobs visible.

#### Possibility of Single Control.

In the case of a local station receiver it is only necessary to have visible a switch to switch it on, as tuning may be carried out once and for all (unless the local station changes its wavelength) and the tuning device clamped in position. The writer has described such a local station receiver in this journal,<sup>1</sup> a remote control being fitted for the switch in this particular set.

When dealing with the reception of two stations it might be thought that visible tuning arrangements would have to be provided so as to tune in the new station when changing over—but this difficulty may be got over in various

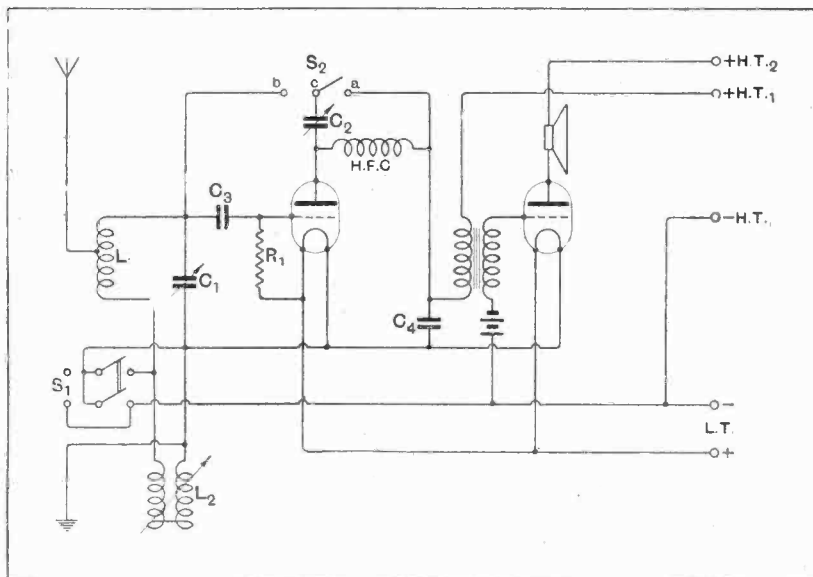

Fig. 1.—The circuit of the receiver, including a switch  $S_2$  for alternative reaction arrangements.  $L_1=75$  turns 26 s.w.g. on 2½ inch for  $\mu r$ ; tapped at 30 turns from bottom for aerial.  $L_2$ =Polar unit as variometer coils 1,100 and 1,450.  $C_1=0.0003$  mfd.;  $C_2=0.0001$  mfd. or less;  $C_3=0.0003$  mfd.;  $C_4=0.0005$  mfd.;  $R_1=1$  megohm;  $S_1$ =Three position switch.

<sup>1</sup> *The Wireless World*, June 9th, 1926.

**Two-Valve Combined Loud-speaker Receiver.—**

ways. First of all, let us see what we are doing when we alter the tuning of a set. Corresponding to every wavelength there is a perfectly definite value for the product  $LC$  of tuning capacity ( $C$ ) and tuning inductance ( $L$ ), and this may be obtained with an infinite number of values of  $L$  and  $C$  as long as their product is constant. Thus we may use a large coil and small condenser, or a small coil and large condenser to receive the same wavelength. It does not follow in practice, of course, that we shall obtain the same signal strength with each arrangement, but that is due to other factors—such as resistance—coming into the question, but in the case under consideration the difference is nothing to worry about.

**Tuning Arrangements for Two Stations.**

In the case of receiving two stations we might duplicate the tuning arrangements—coil and condenser—and switch over from one to the other. Another way would be to use two tuning condensers and a common coil and change over from one to the other. For two stations in the range of one coil and a single tuning condenser of about 0.0005 mfd. this arrangement would be all right, but for the case of one station being between 300 and 500 metres and the other on 1,600 metres it is better to use one condenser and two coils.

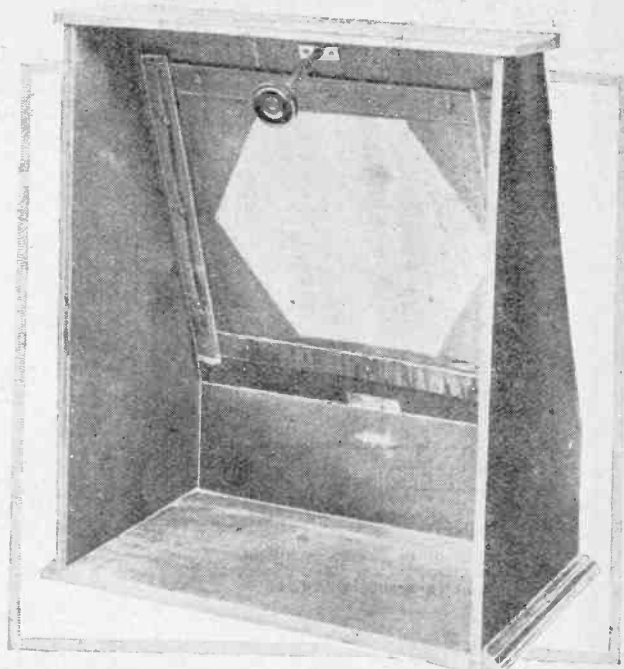

Interior view of the cabinet with the set removed, showing the method of stretching the silk and also the method of fixing the loud-speaker adjustment.

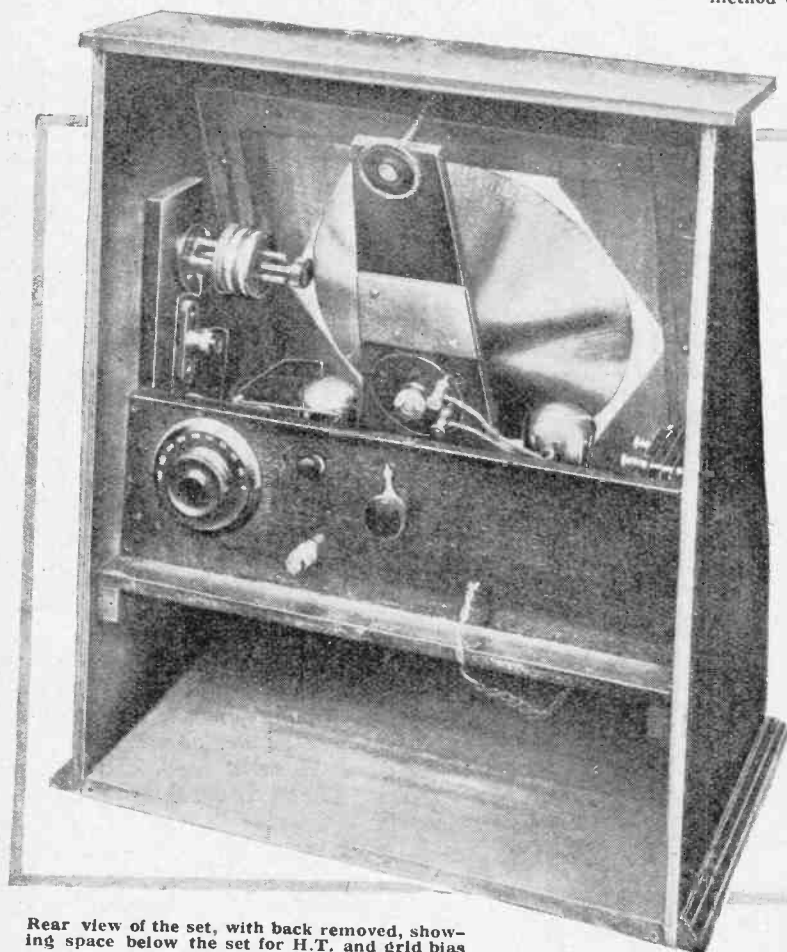

Rear view of the set, with back removed, showing space below the set for H.T. and grid bias batteries.

A 19

In this case—if the tuning arrangements are to be set once for all—the coils must be of exactly the right inductance to tune to the two wavelengths desired with the same tuning capacity. Take, for example, the case of receiving London and Daventry and suppose that we have bought a coil for London and one for Daventry. The chances are thousands to one against those coils tuning in (with the aerial used) to these two stations with *exactly* the same condenser setting; so that one of them will have to be altered. Suppose that the London coil tunes in with  $60^\circ$  on the condenser and the Daventry coil with  $140^\circ$ , for example—this means that the London coil is “comparatively bigger” than the Daventry coil, as it wants less condenser to tune with, so that the alteration required is either to *add* turns to the *Daventry* coil, or, what is probably easier, to *remove* turns from the *London* coil until the two condenser readings are the same. However, it is a wearisome business pulling a coil out of a set and tuning by removing turns, and besides there is a far easier way.

**Variometer Tuning.**

Instead of using two fixed coils, suppose we use one fixed coil and one variometer, which will simplify matters exceedingly, for we first tune in one station on the fixed coil; clamp the condenser; change over to the variometer, and tune in the other

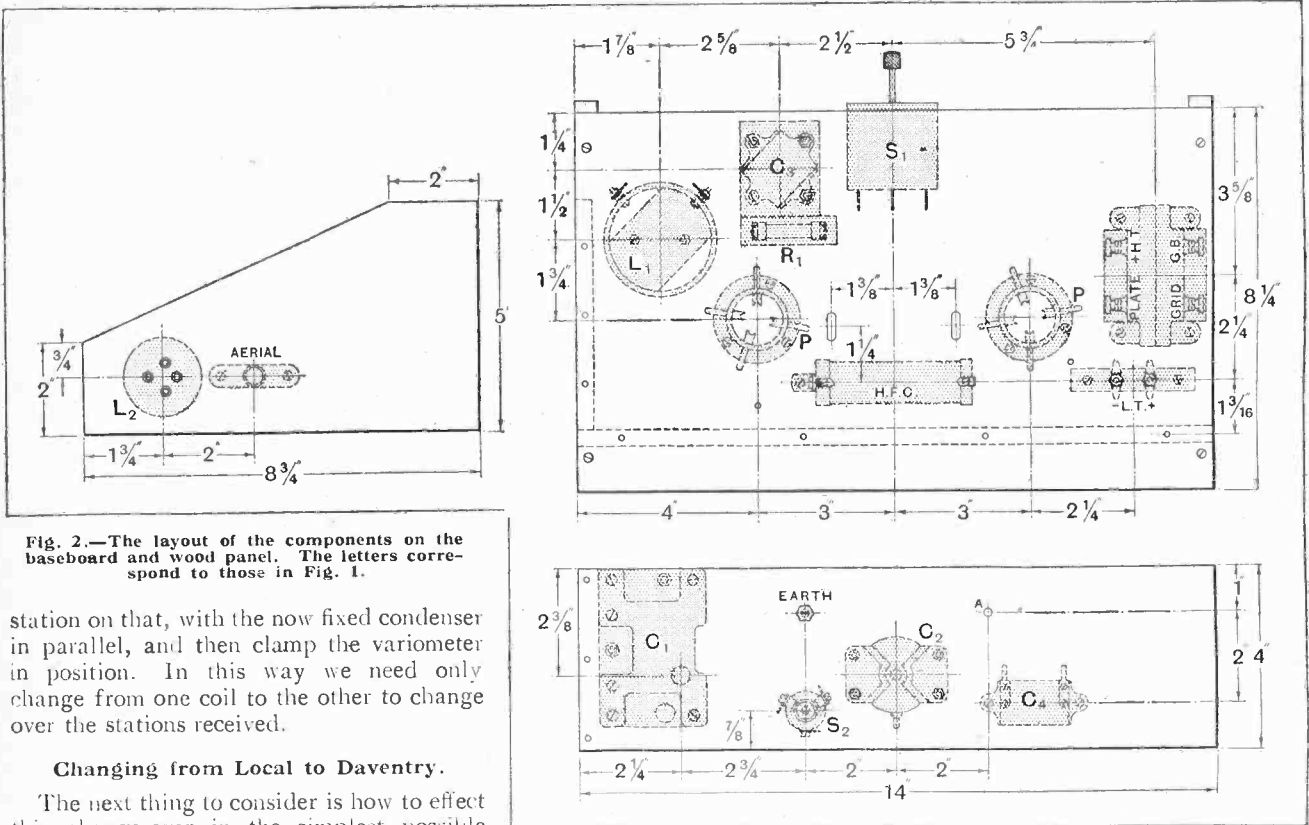

Fig. 2.—The layout of the components on the baseboard and wood panel. The letters correspond to those in Fig. 1.

station on that, with the now fixed condenser in parallel, and then clamp the variometer in position. In this way we need only change from one coil to the other to change over the stations received.

**Changing from Local to Daventry.**

The next thing to consider is how to effect this change-over, in the simplest possible manner. In considering this we must not forget to take advantage of loose coupling on the London wavelength, which not only gives us louder signals with the average aerial but also reduces interference, and at the same time, since the aerial is small compared with the wavelength for Daventry, we require the aerial to be

direct coupled for this station. All these requirements seem as if they would necessitate complicated switching to carry out, but by utilising the aerial circuit arrangement shown in Fig. 1 it will be seen that a simple single pole on-and-off switch will do all that is required. The arrangement used consists in putting the London coil and Daventry variometer in series across the tuning condenser—one end of the London coil being connected to the grid and the other end of the Daventry variometer to the filament of the detecting valve. The aerial is connected some way down the London coil to give the loose coupling effect, the position depending on the length of the aerial used. To receive London, the Daventry variometer is short circuited, thus leaving the aerial loose coupled to the London coil, while to receive Daventry the switch across the variometer is open circuited and the

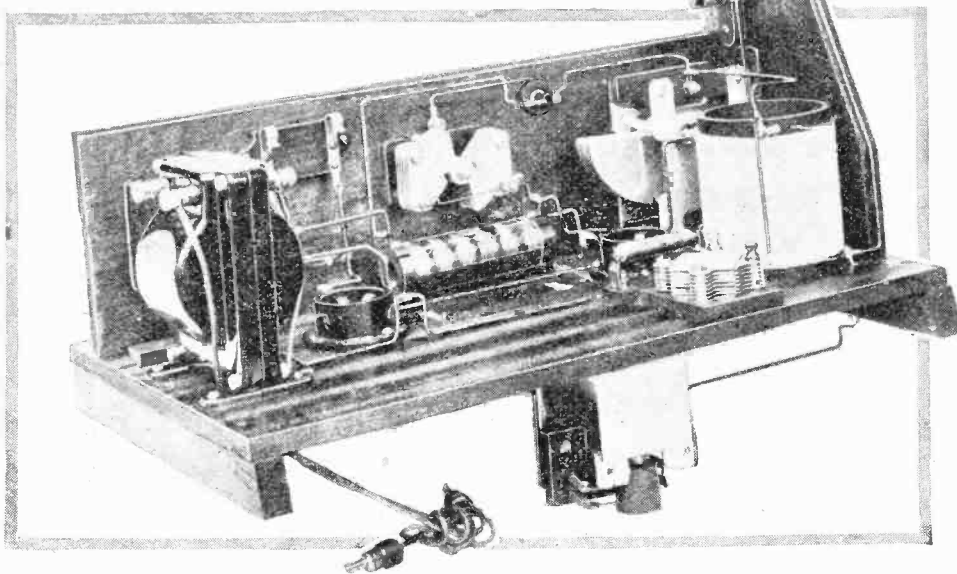

A view of the set removed from the cabinet. The loud-speaker with its clamp has been removed to show the other components more clearly.

LIST OF PARTS.

0.0003 mfd. variable condenser (Ormond).\*  
 0.0003 mfd. fixed condenser (Ormond).\*  
 0.0005 mfd. fixed condenser (Dubilier).  
 Midget condenser (Ormond).  
 Lissenola unit and reed.  
 9-volt grid battery (Ever Ready).\*  
 Poter unit with 1,100 and 1,450 coils.  
 3 Valve holders, baseboard type.\*  
 2-way double pole change-over switch (Utility).\*

Transformer, AF3 Ferranti or Marconi Ideal 4-1 ratio.  
 Belling Lee aerial and earth terminals.\*  
 On-and-off switch (Lissen).\*  
 H.F. choke (Varley or Cosmos).\*  
 2½-inch ebonite or paxolin former, 3 inches long.  
 Small supply of No. 26 d.c.c. wire.  
 Wood for cabinet and baseboard.  
 2 hinges, length of threaded brass rod.  
 Miscellaneous screws, length of flex, etc.

\* Indicates that the components need not necessarily be of the make specified.

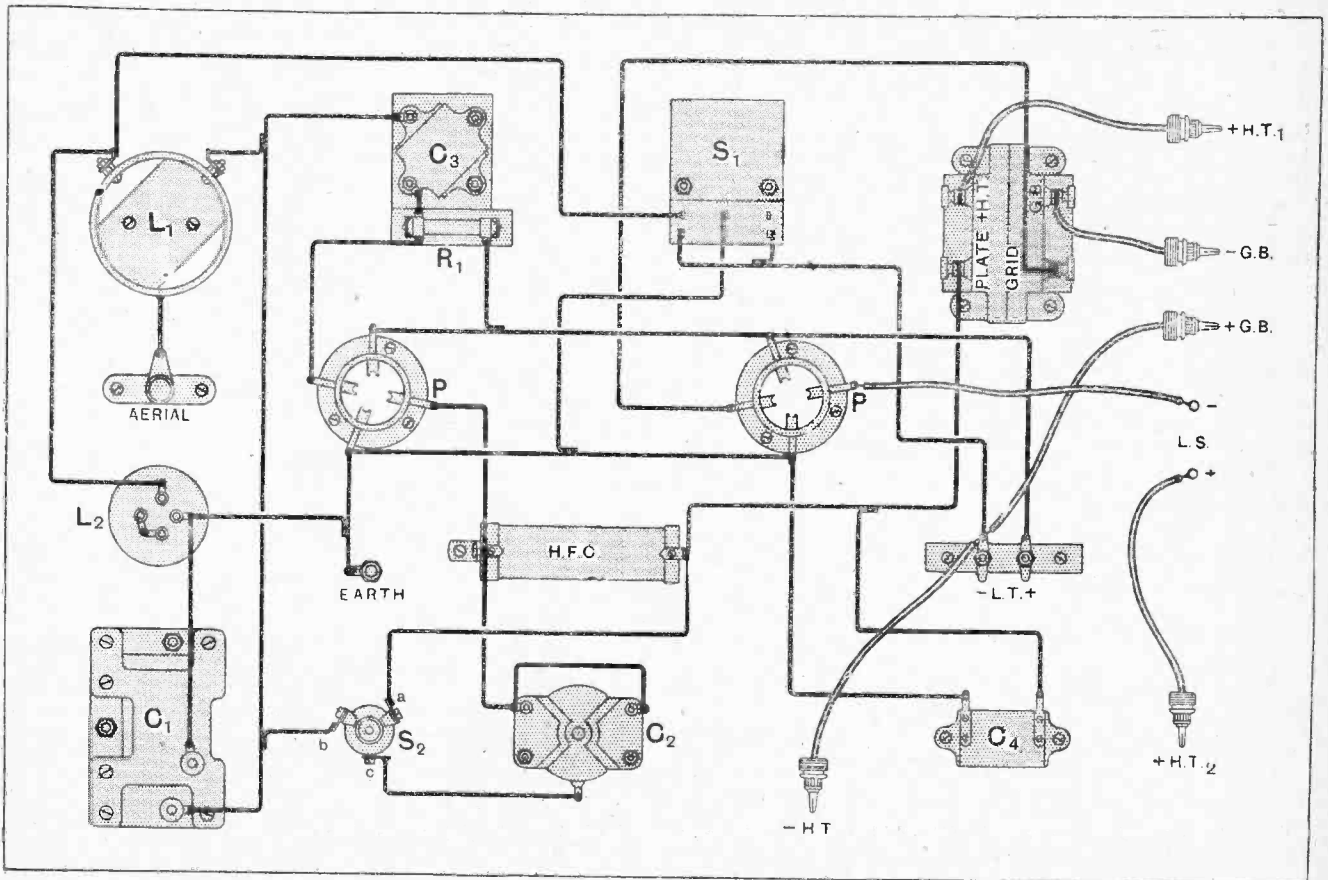

Fig 3.—The wiring diagram of the set. The letters correspond to those in Figs. 1 and 2.

aerial is now practically direct coupled, for the Daventry variometer has ever so much more inductance than the London coil—about sixteen times, in fact.

So much for the tuning arrangements. In order to obtain an "off" position for the switch, the filament supply to the valves is taken through another contact on the switch, so that the valves are on with the switch at either side, but off in the centre position.

The rest of the circuit consists of a valve detector and a transformer-coupled low-frequency amplifier, the whole running a cone loud-speaker of the type recently described by the writer.<sup>1</sup>

For the construction of the cone, the reader is referred to this article, which gives detailed instructions.

<sup>1</sup> *The Wireless World*, November 10th, 1926.

In the circuit given in Fig. 1 provision is made for reaction, but it should here be stated that its use depends on the location of the receiver, and that if the reader lives within loud crystal range of his local station and of Daventry, no reaction will be required for this set, and the choke or coil and reaction condenser need not be incorporated at all.

If the set is to be used close to the local station, but outside loud crystal range from Daventry, then it is advisable to use reaction for Daventry, and this may most conveniently be done by using a plug-in 300 coil in the plate circuit of the detector and tuning it with a small condenser or by using a choke, such as a Cosmos or a Varley, and using a reaction condenser between detector plate and grid—in this case increasing this condenser to



**Two-valve Combined Loud-speaker Receiver.—**

much will stop oscillation. However, in London, for example, unless the aerial available is very bad, it should be possible to get good loud-speaker results without reaction at all.

The actual set embodying these features is illustrated in the photographs and drawings, from which the reader should be able to construct the set without difficulty. A piece of silk is stretched, as shown in the photographs, in front of the loud-speaker to improve appearance and keep the dust out of the set. The aerial coil consists of 75 turns of 26 S.W.G. on a  $2\frac{1}{2}$ in. former, tapped at 30 turns for the aerial.

should only be required to be removed to change a valve, to retune if the stations change their wavelengths, or to renew H.T. and grid bias batteries.

**H.T. Supply.**

Enough space has been left in the base of the set to accommodate the large size Siemens or Ever Ready 108-volt H.T. dry batteries, and these large sizes are recommended if dry batteries are going to be used. If accumulator H.T. is used, as is strongly recommended by the writer, 120 volts of those made by Accumulators Elite—semi-oil type—are very suitable, since they hold their charge for long periods and will only require charging three, or perhaps four, times a year.

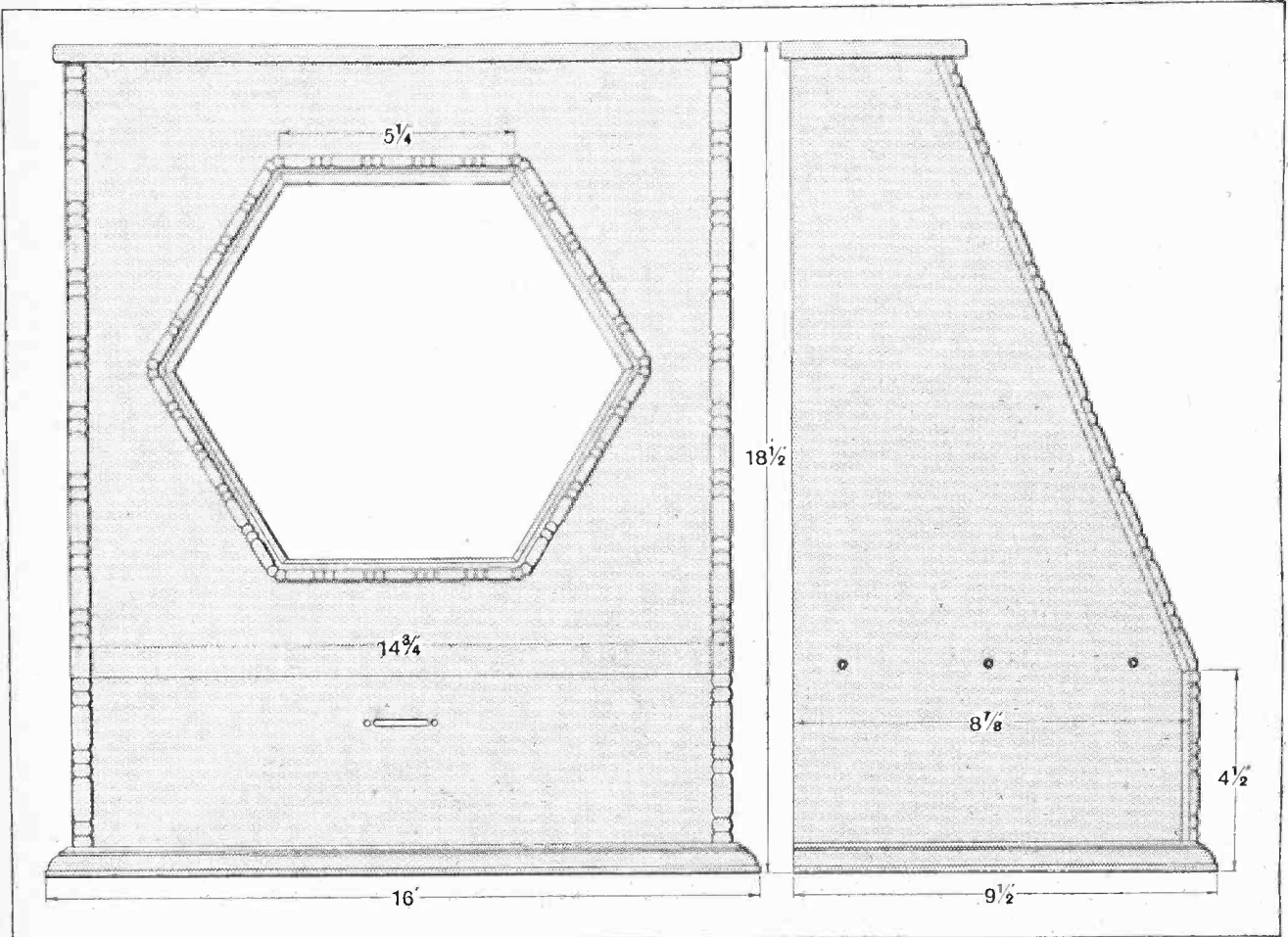

Fig. 4.—Showing the dimensions of the cabinet used, which is made from oak faced three-ply wood.

Provision for adjustment of the loud-speaker is made by slotting the baseboard and mounting the speaker on a clamp hinged at one end and cut at the other to receive a knob working on a screwed brass rod against a strong spring.

**The Condenser Panel.**

The tuning and reaction condensers are mounted at the back of the set and are adjusted with the back removed, but with the aerial, earth, and L.T. wires threaded through. When the adjustments have been made, the back is screwed on and the set thus made fool-proof. This back

In regard to valves, the very dull emitters of the P.M. type are recommended for reasons of economy.

When very close in to the stations, two PM2, PM4, or PM6 type valves should be used, according to the L.T. supply available; and when not so close in, or reaction is being used, the first valve should be either a PM1, PM3, or PM5, with the second valve as above.

There are many variations possible in the cabinet for the set, the one illustrated, which is made of oak-faced 3-ply wood, being merely a suggestion. Also, there are possible variations in some of the components used, the main

**Two-Valve Combined Loud-speaker Receiver.—**

restriction being that a good L.F. transformer must be used to give good quality.

As an example of an alternative, instead of the Daventry variometer, which in the set described consists of a Polar plug-in unit with coils No. 1400 and 1100, an ordinary Daventry coil might be bought and made into a variometer by mounting a copper sheet so that it covered more or less of the coil after the fashion of the well-known "spade" tuning.

In conclusion, it might be said that this set is easy to construct, does not look like the usual run of radio sets, and is very simple indeed to use, and the total cost of the set as described works out to just under five guineas, excluding valves and batteries.

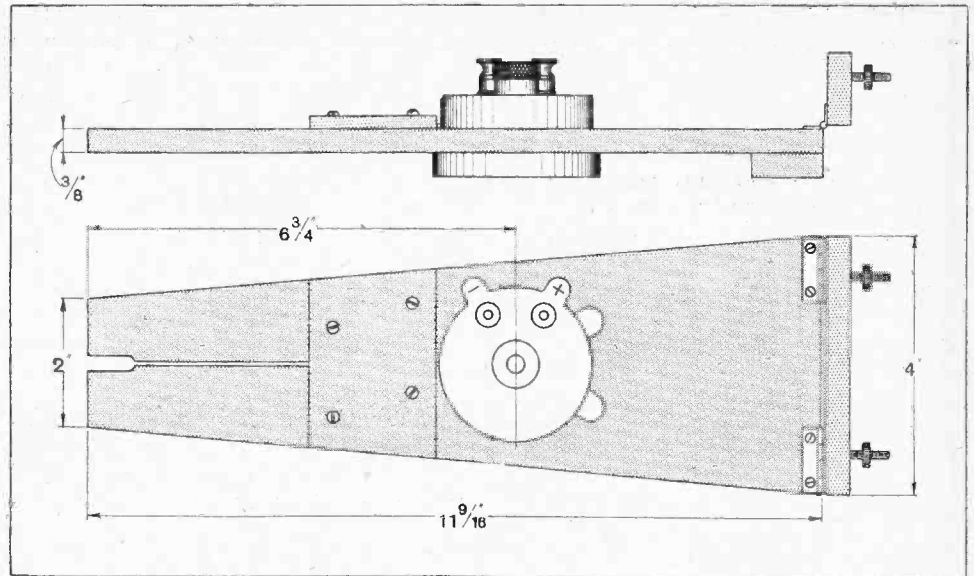

Fig. 5.—Showing the dimensions of the clamp and method of mounting the Lissenola loud-speaker unit.

For the benefit of those who wish to incorporate a more powerful form of loud-speaker than that provided by fitting the Lissenola unit with a cone, the writer has carried out some experiments with a more powerful unit, which, however, has to undergo a slight alteration before it can be used.

The unit referred to is the Brown gramophone attachment, and the required alteration consists of the fitting of a screwed rod on to the reed in place of the little screw which fixes the conical aluminium diaphragm to the latter. A rod already screwed at one end to fit the thread on the Brown reed, complete with nuts and washers, may be obtained from J. W. Miller, 68, Farringdon Street, E.C.4, for a few pence. When ordering this rod it should be specified that the reduced portion (to fit the reed) must be tapped for 1/4 inch.

**Fixing the Rod.**

To fix the rod in position, take off the ebonite back of the Brown unit by removing the four holding screws and the adjusting knob—which may be unscrewed after the little screw stop has been taken out.

Underneath will be seen the way in which the diaphragm is fixed to the reed. The holding screw is soldered on, and should be unsoldered with a very hot iron, the screw removed from the other side of the unit, and the rod screwed in and soldered up. The small tubular projection on the front of the unit on which the rubber connection fits should be *lightly* packed with cotton-wool to help take the weight of the cone and the rod.

The clamp for the loud-speaker unit, shown in Fig. 5 above, will have to be modified slightly by being made wider where the hole for the unit is cut, as the Brown unit is larger than the Lissenola. The cost of the Brown unit is £2, so that the complete cost of the set including this would be about £6 12s.

In the writer's opinion, the extra output obtainable from the Brown unit is decidedly worth the extra expense, and a description of a really large cone speaker driven by this unit will be given in a later article.

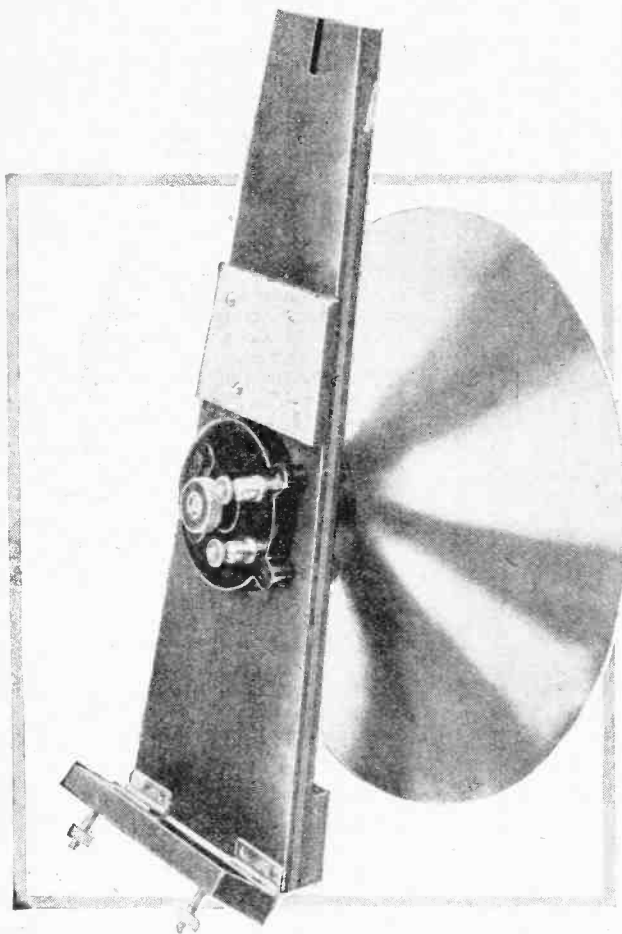
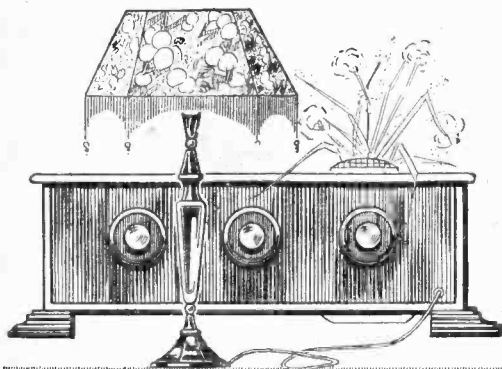

Fig. 6.—A view of the loud-speaker unit with its clamp.



# NEW WAVELENGTHS OF European Broadcast Stations.

*Apart from minor alterations, the wavelengths allotted under the Geneva scheme will probably remain as shown below for a considerable period. The stations are given in order of wavelength.*

Metres.	Station.	Power.	Metres.	Station.	Power.	Metres	Station.	Power.
4000	Berlin (Königswusterhausen), AFP.	10 kW.	370.4	Oslo (Norway).	1.5 kW.	241.9	Muenster (Germany), ms, in Morse.	3 kW.
2900	Paris (Eiffel Tower), FL.	5 kW.	368	Tainmafors (Finland).	—	240	Helsingfors (Finland).	2 kW.
2650	Lyngby (Denmark).	0.5 kW.	365.8	Graz (Austria).	0.5 kW.	238.1	Bordeaux (Relays PTT Paris).	0.5 kW.
2400	Amsterdam, PCFF.	2 kW.	361.4	London (2LO).	3 kW.	233	Uleaborg (Finland).	0.2 kW.
2125	Kovno (Lithuania).	—	357.1	Leipzig (Germany).	9 kW.	229	Umea (Sweden).	—
2000	Norddeich (Germany).	—	353	Cardiff (5WA).	1.5 kW.	225.6	Belgrade (Serbia).	2 kW.
1800	Paris (Radio-Paris), CFR.	3 kW.	350	Paris (Radio LL).	0.25 kW.	223.9	Leningrad (Russia).	0.2 kW.
1750	Daventry (5XX).	25 kW.	348.9	Prague (Czecho-Slovakia).	5 kW.	222.2	Strasbourg.	0.1 kW.
1600	Riga (Latvia).	2 kW.	344.8	Seville (Radio Club de Sevillano), EAJ5.	1 kW.	221	Karlstadt (Sweden).	0.25 kW.
1500	Moscow (Central), RDW.	12 kW.	340.9	Paris (Petit Parisien).	0.5 kW.	219	Kovno (Lithuania).	—
1450	Nijni Novgorod (Russia).	1.2 kW.	337	Copenhagen (Denmark).	2 kW.	218	Orebro (Sweden).	—
1400	Karlsborg (Sweden).	5 kW.	333.3	Reykjavik (Iceland).	0.5 kW.	217.4	Luxembourg.	0.25 kW.
1365	Berlin (Königswusterhausen)	—	330	Bordeaux (Rad. Sud. Ouest).	0.2 kW.	211.3	Kiev (Russia).	2 kW.
1300	AFI.	10 kW.	329.7	Nuremberg (Germany).	0.7 kW.	204.1	Gavle (Sweden), SMXF.	0.25 kW.
1200	Boden (Sweden), SASE.	1.5 kW.	326.1	Belfast (2BE).	1.5 kW.	204.1	Salamanca (Spain), EAJ22.	0.5 kW.
1150	Ryvang (Denmark).	0.5 kW.	322.6	Breslau (Germany).	4 kW.	202.7	Kristinehamn (Sweden), SMTY.	0.1 kW.
1150	Sorø (Denmark).	1.5 kW.	319.1	Dublin (2RN).	1.5 kW.	201.3	Jonköping (Sweden), SMZD.	0.5 kW.
1110	Khbelv (Czecho-Slovakia).	1 kW.	315.8	Milan, IMI.	—	196	Karlskrona (Sweden), SMSM.	0.25 kW.
1100	De Bilt (Holland).	—	315	Uppsala (Sweden).	0.25 kW.	95	Beziers (France).	0.1 kW.
1050	Hilversum (Holland), HDO.	5 kW.	312.5	Newcastle (5NO).	1.5 kW.			
1010	Moscow (Popoff).	2 kW.	309.3	Marseilles, PTT.	0.5 kW.			
1000	Basle (Switzerland).	1.5 kW.	306.1	Bournemouth (6BM).	1.5 kW.			
940	Leningrad (Russia).	2 kW.	305	Casablanca (Morocco).	0.6 kW.			
850	Lausanne (Switzerland), HB2.	1.5 kW.	303	Königsberg (Germany).	1 kW.			
780	Geneva (Radio-Geneva).	1.5 kW.	300	Bratislava (Czecho-Slovakia).	0.5 kW.			
720	Ostersund (Sweden).	1 kW.	297	Cartagena (Spain), EAJ16.	1 kW.			
577	Vienna (Radio-Wien).	1.5 kW.	297	Leeds (2LS).	0.2 kW.			
577	Madrid (Radio-Iberica), EAJ6.	3 kW.	297	Hanover (Germany).	1.5 kW.			
566	Berlin (Magdeburger Platz).	2 kW.	297	Varberg (Sweden).	—			
566	Saragossa (Spain), EAJ23.	1 kW.	297	Jyväskylä (Finland).	0.2 kW.			
566	Bloemendaal (Holland).	0.04 kW.	297	Agen (France).	0.25 kW.			
555.6	Budapest (Hungary).	2 kW.	294.1	Liège (Belgium).	—			
545.6	Sundsvall (Sweden), SASD.	0.5 kW.	294.1	Dresden (Germany).	1.5 kW.			
535.7	Munich (Germany).	1.5 kW.	294.1	Bradford (2LS).	0.2 kW.			
526.3	Riga (Latvia).	2 kW.	294.1	Bilbao (Spain) (Radio-Vizcaya), EAJ11.	2 kW.			
517.2	Rosenhugel (Austria).	5 kW.	294.1	Uddevalla (Sweden).	—			
508.5	Brussels (Belgium).	1.5 kW.	291.3	Kyov (Radio-Lyon).	0.5 kW.			
500	Helsingfors (Finland).	1 kW.	288.5	Hull (6KH).	0.2 kW.			
500	Linköping (Sweden).	0.25 kW.	288.5	Liverpool (6LV).	0.2 kW.			
500	Barcelona (Spain) (Radio-Catalana), EAJ13.	1 kW.	288.5	Plymouth (5PY).	0.2 kW.			
500	Zurich (Switzerland).	1 kW.	288.5	Stoke (England) (6ST).	0.2 kW.			
491.8	Aberdeen (2BD).	1.5 kW.	288.5	Swansea (5SX).	0.2 kW.			
491.8	Birmingham, 5FT.	1.5 kW.	288.5	Edinburgh (2EH).	0.2 kW.			
483.9	Berlin (Witzleben).	4 kW.	288.5	Nottingham (5NO).	2 kW.			
478.2	Lyons (France) (La Doua).	1 kW.	288.5	Dundee (2DE).	0.2 kW.			
468.8	Elberfeld (Germany).	1.5 kW.	288.5	Sheffield (6PL).	0.2 kW.			
461.5	Bergen (Norway).	1.5 kW.	283	Dortmund (Germany).	1.5 kW.			
454.5	Stockholm, SASA.	1.5 kW.	280.4	Barcelona (Spain) (Radio-Barcelona), EAJ1.	1 kW.			
450	Moscow (Trades Union).	2 kW.	277.8	Seville (Spain) (Radio-Sevilla), EAJ17.	1 kW.			
447.8	Paris (Ecole Supérieure), FPTT.	0.45 kW.	277.8	Caen (France).	0.5 kW.			
445	Kjukan (Norway).	0.05 kW.	277.8	Trollhättan (Sweden), SMXQm.	0.12 kW.			
441.2	Brünn (Czecho-Slovakia).	2.4 kW.	275.2	Zagreb (Jugo-Slavia).	0.35 kW.			
434.8	Bilbao (Spain) (Radio Club de Vizcaya), EAJ9.	1 kW.	275.2	Madrid (Radio-Castilla), EAJ4.	3 kW.			
434	Porsgrund (Norway).	0.7 kW.	275.2	Norrköping (Sweden), SMVV.	0.25 kW.			
423.6	Frankfurt (Germany).	10 kW.	275.2	Angers (France) (Radio-Anjou).	0.5 kW.			
422.6	Rome (IRO).	3 kW.	272.7	Cassel (Germany).	1.5 kW.			
420	Moscow (Radio-Peredatcha).	2 kW.	272.7	San Sebastian (Spain), EAJ8.	2 kW.			
416.7	Göteborg (Sweden), SASB.	1 kW.	272.7	Danzig (Germany).	1.5 kW.			
411	Berne (Switzerland).	1.2 kW.	265.5	Antwerp (Belgium).	0.1 kW.			
405.4	Glasgow (5SC).	1.5 kW.	260.9	Malmö (Sweden), SASC.	0.5 kW.			
400	Bremen (Germany).	1.5 kW.	254.2	Malaga (Spain), EAJ25.	1 kW.			
400	Cadiz (Spain), EAJ3.	0.55 kW.	254.2	Kalmar (Sweden), SMSN.	0.25 kW.			
400	Falun (Sweden), SMZK.	1.5 kW.	254.2	Kiel (Germany).	1.5 kW.			
400	Kosice (Czecho-Slovakia).	5 kW.	252.1	Montpellier (France).	1 kW.			
400	Mont de Marsan (France).	0.3 kW.	252.1	Stettin (Germany).	0.45 kW.			
400	Warsaw (Poland).	1.5 kW.	250	Säille (Sweden), SMTS.	0.5 kW.			
394.7	Hamburg, ha, in Morse.	10 kW.	250	Esikistuna (Sweden).	0.25 kW.			
389.6	Toulouse (France) (Rad. du Midi).	2 kW.	245	Gleiwitz (Germany).	1.5 kW.			
384.6	Manchester (2ZY).	1.5 kW.	243.9	Toulouse (France), PTT.	2 kW.			
379.7	Stuttgart (Germany).	1.5 kW.		Trondheim (Norway).	—			
375	Madrid (Union Radio), EAJ7.	6 kW.						

## BOOKS RECEIVED.

"The Fifth Post Annual, 1927." Contains numerous short stories and articles of a popular nature directly or indirectly concerned with the work of the Post Office. The book is attractively written and profusely illustrated; many of the articles, photographs and drawings are the work of Post Office servants. Printed and published by Percy Bros., Ltd., London and Manchester, price 1s. Five per cent. of the proceeds from the sale will be handed over to the Post Office Sanatorium Society.

o o o

"Alternating Current Rectification and Allied Problems" (second edition, revised and enlarged), by L. B. W. Jolley, M.A., M.I.E.E., Assoc. Amer. I.E.E. pp. 472, with 340 illustrations and diagrams. Published by Chapman and Hall, Ltd., London. Price 30s. net.

o o o

"Successful Crystal and One-Valve Circuits." By J. H. Watkins. pp. 104, with 86 diagrams. Explaining, in simple language, the theory and practice of crystal and single-valve circuits with details of circuits actually tested by the writer and notes on their comparative merits. Published by Sir Isaac Pitman & Sons, Ltd., London. Price 3s. 6d. net.

# HINTS and TIPS for NEW READERS

A Section Devoted to the Practical Assistance of the Beginner.

## USING THE CARBORUNDUM DETECTOR.

There seems to be a definite revival of interest in the carborundum detector, partly due, no doubt, to the fact that it is now more easily obtainable both in the "cartridge" and unmounted forms. When comparatively weak signals are to be received, it is well known that the application of a bias voltage is necessary, and the circuit shown in Fig. 1 is, under certain circumstances, a useful alternative to the more usual potentiometer method, particularly when panel space is limited.

A consideration of the diagram will show that the dry cell, the resistance R, and the crystal are connected in series. By varying the value of the resistance, the voltage dropped across it (and consequently that applied to

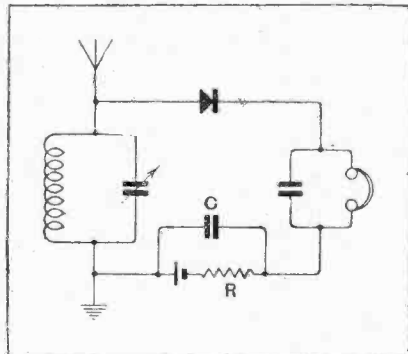

Fig. 1.—A crystal receiver with carborundum detector.

the crystal) is changed. In practice, it is found that a value of 200,000 ohms is often about the best, although it must be remembered that the characteristics of individual detectors vary considerably, both as regards their resistance and the applied voltage necessary for best rectification.

A large condenser (C) is connected

across the resistance and serves to bypass the pulsating rectified currents, to which it offers a comparatively low resistance. Its value should be not less than 0.25 mfd.; a considerably larger one may be used if available.

A switch may be fitted to break the battery circuit when the receiver is not in use, but this is hardly necessary, as the current passed is very small, due to the presence in the circuit of high resistances.

The correct polarity of the battery can best be ascertained by reversing its connection; in one position its presence will have a distinct weakening effect on signals.

o o o o

## GRID BIAS.

Frequent mention has been made, in these pages and elsewhere, of the fact that amplitude distortion or overloading is more serious in a resistance L.F. amplifier than in a transformer-coupled instrument. The same remark is, of course, true of choke coupling, as a grid condenser is also necessary in this arrangement.

The best and most certain way of avoiding overloading is to use large power valves, with adequate H.T. voltage, but unfortunately this is a somewhat expensive matter; the first cost and upkeep of such valves is higher than that of the ordinary types. Much may be done, however, by working the set to its best advantage, and it is always better to be satisfied with moderate volume and freedom from distortion than to run the set up to its limit of sensitivity, with consequent overloading on loud passages.

While the effect of a slightly excessive amount of negative grid bias will, in the case of a transformer amplifier, be about as bad as when

an insufficient voltage is applied, it should be remembered that different conditions obtain with resistance coupling, and, generally speaking, it will be better to err towards the use of too much bias rather than too little. In other words, if the output valve is to be operated up to the limit of its capacity, it is less harmful if exceptionally large voltage swings give rise to rectification, due to encroachment on to the lower bend of the curve, than that they should start the flow of grid currents by causing the grid to become momentarily positive with respect to the filament.

o o o o

## CONDENSER SWITCHES.

It is sometimes desirable to have an easy control, in steps, over the total amount of capacity in circuit, particularly in "tone changing" circuits. For this purpose some form of switching device can be arranged on the lines shown in Fig. 2. The first (a) allows any one of the

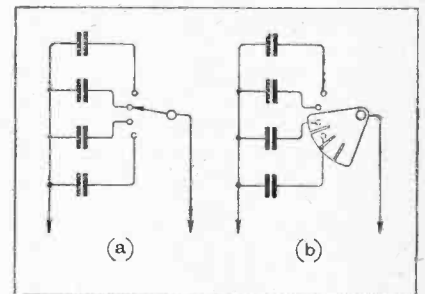

Fig. 2.—Condenser selector switches.

individual condensers (which will, of course, be of different capacities), to be included in circuit, and is the most generally useful. The second (b) requires a switch with a wide blade, which, as it is rotated, will short-circuit all the studs over which it passes. The capacities of the indi-

vidual condensers are thus added together as contact is made with the different studs to which they are connected.

Where fine control of capacity is necessary, a variable condenser may be connected across the leads to the external circuit.

**SAFEGUARDING POWER VALVES.**

When working a valve with a high H.T. voltage, perhaps even exceeding

the maximum recommended by the manufacturers, it is as well to make it a rule never to break, even momentarily, the circuit to the grid bias battery while the filament is glowing. Unless this precaution is observed, a very heavy anode current will flow when the grid is at zero voltage (as is the case when its circuit to the filament is "open") and the valve may be injured, or, at best, its useful life will be reduced.

It is therefore recommended, before an experimental change in bias voltage is made, that the filament should be switched off. Alternatively the H.T. feed lead to the particular valve in question may be disconnected, but this course cannot be considered as preferable, particularly when there is an iron-cored inductance (L.F. choke, L.F. transformer or loud-speaker) in series with the anode which may produce a high back E.M.F.

**DISSECTED DIAGRAMS.**

Step-by-step Wiring in Theory and Practice.

No. 49 (b).—A Single-valve Reflex Receiver.

(Concluded from last week's issue.)

*In this series of diagrams it is hoped to make clear the steps to be taken in converting theory into practice in the construction of various typical wireless receivers. Provided that suitable components are chosen, the arrangement shown below is capable of giving very loud signals with a minimum upkeep cost. The prospective constructor is advised to read an article on this subject which appeared in "The Wireless World" for October 20th, 1926.*

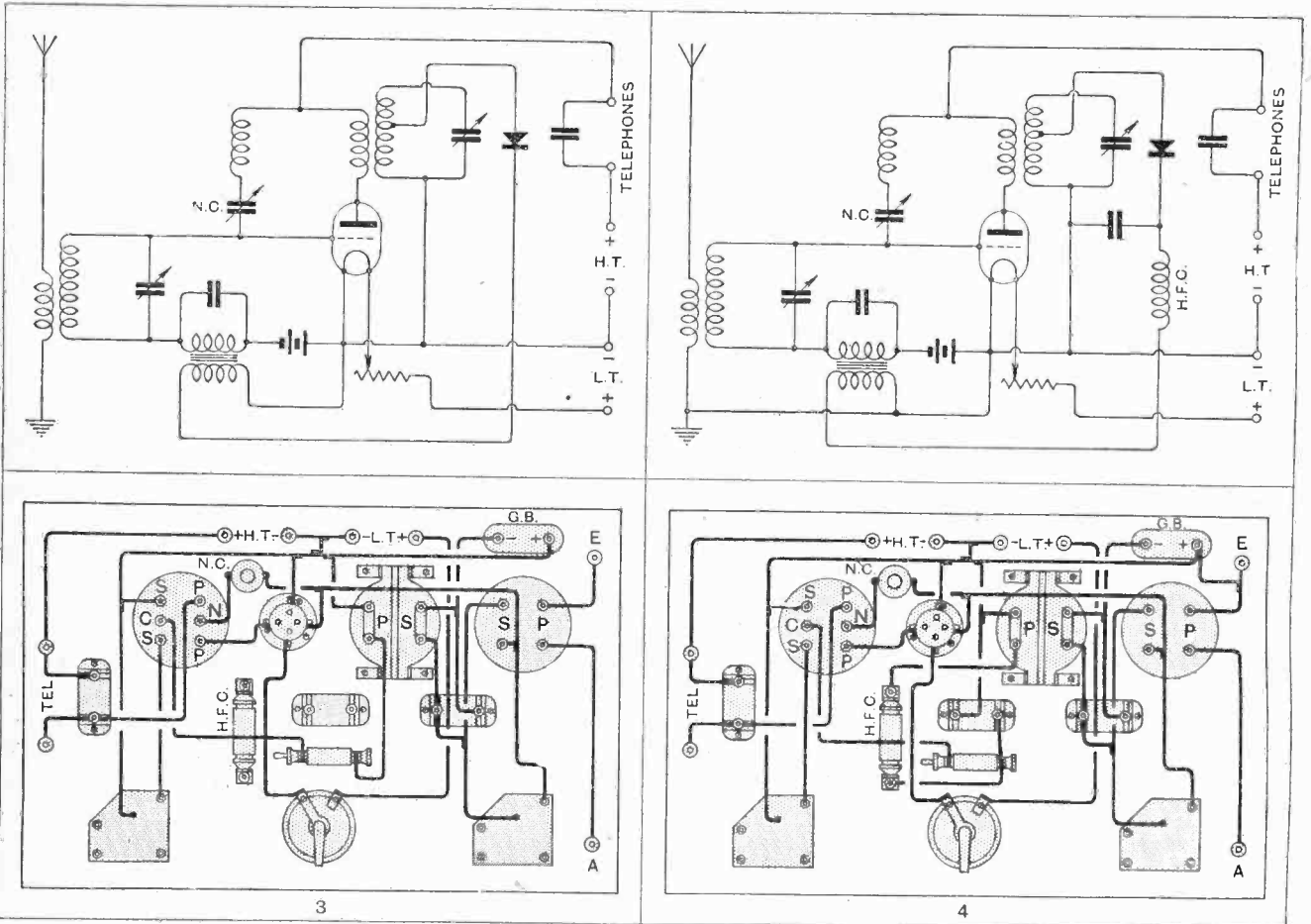

The detector circuit is completed through the primary of the L.F. transformer. Note that the crystal is connected across only a part of the inductance, in order to reduce its damping effect, and that the low-potential end of the tuned transformer secondary is connected to the L.T. for additional stability.

An H.F. by-pass condenser is connected across the crystal output, while an H.F. choke is inserted to assist further in deflecting high-frequency currents. The use of this latter component is by no means essential, but is often helpful. The negative side of the low-tension battery is connected to earth.



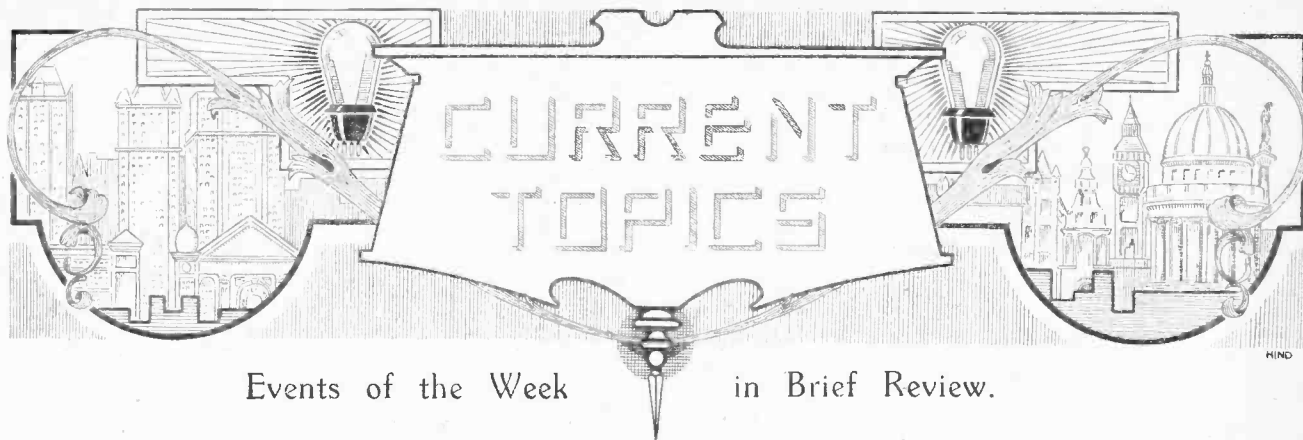

Events of the Week in Brief Review.

**PLAUSIBLE OBJECTION TO WIRELESS.**

The Dewsbury Guardians have decided not to install a wireless set in the local infirmary. One Guardian objected, on the grounds that the innovation would "make the place too attractive!"

**WHAT IS SATISFACTION?**

Harold Greenwood, of Ramsgill, Yorks, who was last week fined 10s. and 30s. costs for installing and operating a wireless set without a licence, remarked that he did not think a licence necessary, as the set was not working to his satisfaction.

**THE MAN NEXT DOOR.**

When a man told Mr. Clarke Hall, the Old Street magistrate, that he had stretched his aerial across his neighbour's garden, but had been requested to remove it, Mr. Hall said: "Your neighbour owns everything above his property right up to Heaven, and I am afraid you will have to take your aerial down."

**LICENCES FOR THE DEAF.**

Many deaf mutes are able to hear broadcasting by means of headphones, and most wireless enthusiasts will readily concur with the suggestion recently made that the Wireless Telegraphy (Blind Persons Facilities) Bill should be amended to grant deaf mutes free receiving licences in the same way as blind persons.

**SUCCESS OF NATIONAL WIRELESS WEEK.**

Already there are indications that National Wireless Week, with its slogan "Let Your Friends Listen," has borne fruit, though its ultimate effect upon the popularity and growth of broadcasting can only be judged over an extended period.

In an interview with Mr. Sholl, Editor of *The Wireless Trader* and organiser of National Wireless Week, a representative of *The Wireless World* was informed that especially encouraging reports had been received from Belfast and also from the South Coast, Brighton apparently being one of the centres where public interest in wireless is becoming increasingly evident. "As far as present reports go," said Mr. Sholl, "the Week was a success, but we must, of course, reserve judgment until later in the season."

**QUARTZ CRYSTALS.**

At the ordinary meeting this evening (Wednesday) of the Radio Society of Great Britain, Mr. A. Hinderlich, M.A., will lecture on "Quartz Crystals and Practical Circuits."

**WIRELESS LIE SENSE.**

"Wireless pirates are entitled to no more sympathy than the man who walks into a theatre without a ticket in the hope that no one will notice him. They have the lie sense but not the licence."—*Manchester Evening News.*

**CONCERTS ON RUSSIAN TRAINS.**

Passengers on the Moscow-Leningrad express now enjoy broadcast concerts while *en route*. The Soviet authorities have just installed an experimental equipment on this train, and if the venture proves popular other trains will be similarly equipped. Each compartment contains wall plugs for loud-speakers and telephones.

**CANADIAN RADIO BOOM?**

A wireless boom in Canada is foretold by the Department of Commerce, Ottawa. All previous records for the sale of wireless apparatus will probably be broken during the next few weeks. Canada now possesses 67 broadcasting stations.

**WIRELESS ON TANKS.**

Wireless direction of tanks was a feature of the armament display witnessed by the Dominion Premiers at Camberley on November 12th. During the manoeuvres the visitors were shown how a body of tanks can operate together in warfare by means of wireless instructions from the officer-in-charge. Formerly each tank was a separate unit, out of touch with H.Q.

**BROADCASTING PICTURES.**

Probably within the next fortnight the Radiola Station in Paris will begin broadcasting pictures. These transmissions will be for the benefit of listeners

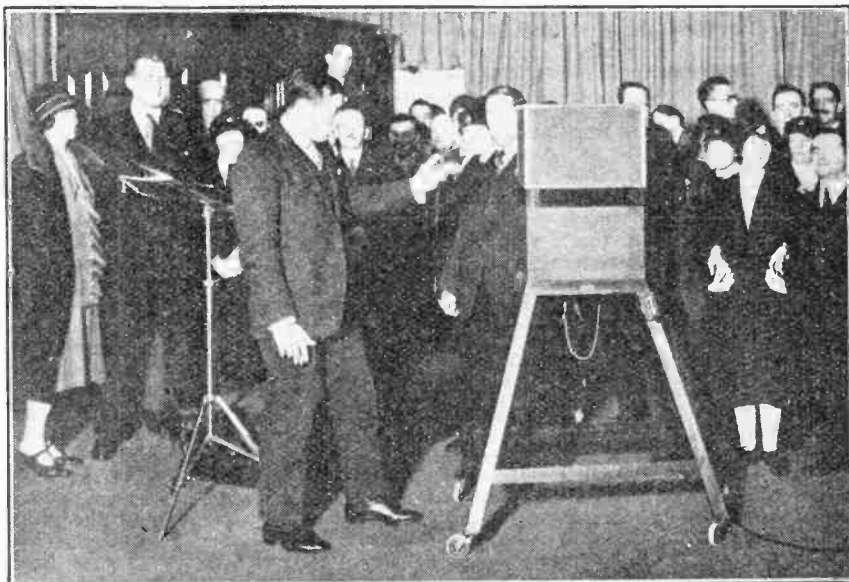

**WIRELESS AND THE BLIND.** Appropriately enough, in view of the introduction of Captain Fraser's Bill for granting free licences to the blind, the B.B.C. invited the men of St. Dunstan's to 2LO on Saturday, November 13th. Captain Eckersley is here seen explaining to the visitors the mysteries of the microphone. Captain Ian Fraser, M.P., will be recognised on the left.

## THE BROADCASTING DEBATE.

BY OUR PARLIAMENTARY CORRESPONDENT.

who have installed the "telectograph," a picture-receiving outfit somewhat similar to that described in *The Wireless World* of March 24th last. The "telectograph" is being produced for amateurs at a cost of £10 to £12. The experiments are under the control of the well-known inventor, Mr. T. Thorne Baker.

## SHORT WAVES ELIMINATE INTERFERENCE.

Amateur interference with broadcast programmes, according to the American Radio Relay League, is now a thing of the past. This happy state of affairs is ascribed to the use of short waves by amateurs and the great improvement in broadcast receivers.

## WIRELESS BOOMING IN CEYLON.

Broadcasting is developing slowly but surely in Ceylon, writes a correspondent. During September the total number of applications for receiving licences was twice as large as in any previous month. The increased public interest is due to the great improvements introduced into the broadcast programmes.

## AMERICAN WIRELESS IMPROVEMENT.

A marked improvement in the financial position of the Radio Corporation of America is disclosed by the figures for the quarter ended September, as compared with the period to June. The three months yielded surplus profits of \$2,116,100, the previous quarter yielding \$82,000 only.

## BROADCAST CONCERTS ON THE PHONE.

The proposed scheme for the distribution of broadcast programmes in Holland by the ordinary telephone service, already referred to in *The Wireless World*, was brought into operation by the Hague Municipal Telephone Service on November 1st.

The ordinary telephone service is not affected. When a subscriber receives a call the broadcasting connection is switched off automatically.

## AMATEURS AND AN EXPEDITION.

Through the agency of a portable short-wave transmitter, the Roosevelt "River of Doubt" Expedition now penetrating the Brazilian jungle region is being kept in constant touch with the United States. Many American amateurs in the Eastern States pick up the expedition messages nightly, and the news is conveyed by wireless to the New York papers.

## BRANDES VALVE RECEIVERS.

We regret that, owing to an oversight, the particulars regarding the receivers made by Messrs. Brandes, Ltd., 296, Regent St., W.1., were omitted from our Buyers' Guide on 10th inst. These well-known sets are:—(a) Brandset II, in polished walnut cabinet and arranged for 1 detector and 1 L.F. valve, price £6 10s. 0d. (b) Brandset III, a similar receiver but with 1 detector and 2 L.F. valves, price £8 10s. 0d. No plug-in coils are required; the standard coil is tunable for Daventry. The prices given do not include valves, batteries or other accessories.

For several hours on Monday, November 15th, the House of Commons discussed the future of broadcasting and the conditions of the grant of the Charter to the new Corporation. There were some criticisms, but eventually the necessary supplementary estimate of £295,000 was agreed to without a division.

Sir William Mitchell-Thomson, the Postmaster-General, in introducing the estimate, referred first of all to the growth of broadcasting, and went on to point out the necessity for some State interference to prevent chaos, and reviewed the work of the Crawford Committee and the character of the new Corporation.

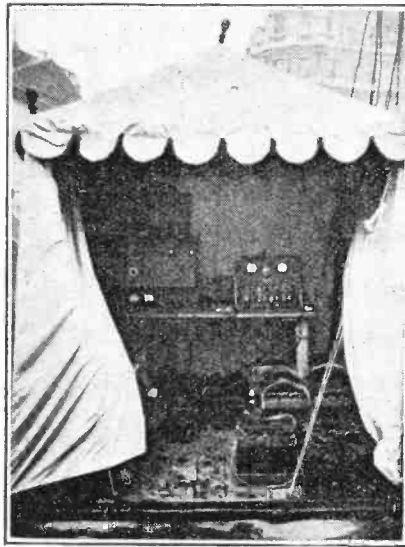

**LATEST IN AMPLIFIERS.** The new Marconiphone speech amplifying equipment as used in the Armistice Celebration at the Royal Exchange, London. Fewer amplification stages are now used owing to the extreme sensitivity of the Marconi-Reisz microphone.

## Organisation.

As regards the organisation of the service, the Corporation would, he said, be given an absolutely free hand, but Mr. J. C. W. Reith would continue to be the chief executive officer, and it was the general intention of the governors to take over the whole of the existing staff of the B.B.C. on January 1st. On March 31st last there were 1,964,000 licences; on October 31st, 2,097,000; and it was estimated that if trade revived there would be on March 31st next 2,200,000 licences. The cost of collecting the licence duty would be done in the long run at 12½ per cent. of the gross revenue, and so from the gross revenue there was deducted 12½ per cent. to reach a net figure to be apportioned between the Exchequer and the dividing authorities. So far as the immediate financial position was concerned, he was satisfied that the revenue would be adequate. In the first eighteen months of the opera-

tion of the old company it received £177,000. For the year ended March 31st, 1925, the revenue was £489,000; for the year ended March 31st, 1926, it was £500,000, and for the current financial year the company for nine months and the Corporation for three months would receive £732,000. If, as was anticipated, the listeners reached 2,200,000 on March 31st, 1927, the Corporation would receive in its first financial year £805,000, and if the listeners increased by another 200,000 in the following year the Corporation would receive £866,000. The State retained £159,000 this year, next year it would retain £245,000, and the year after £271,000.

## Government Control in Emergency.

Powers of control over the waveband had been retained, and a provision had been inserted in the Charter that the Corporation should broadcast matter if requested to do so by a government department. An important provision was that of the resumption of full control over the service by the Government in case of national emergency—an absolutely necessary and vital provision. Subject to those limitations, he proposed to give the Governors the greatest possible liberty within the terms of the Charter. His desire was to make the broadcasting service not a Department of State, still less a creature of the Executive, but, so far as was consistent with Ministerial responsibility, an independent body of trustees.

## Governors' Remuneration.

Viscount Wolmer informed Sir Walter de Frece that, under the Articles of Association of the British Broadcasting Company, the remuneration of the directors, apart from the emoluments of the managing director, was limited to £500 a year for the chairman, and £200 a year for each of the nine other members of the board. The Charter provided that the Governors of the new Corporation might receive remuneration not exceeding £3,000 for the chairman, £1,000 for the vice-chairman, and £700 for the other Governors. In 1924 a bonus of £2,000 was paid to the directors of the British Broadcasting Company. The directorate of the Corporation were precluded by their Charter from accepting any bonus.

## Composition of the Board.

Sir Walter de Frece asked, further, why, in view of the fact that entertainment formed the bulk of broadcasting programmes, steps were not taken in constituting the board to include persons with special knowledge of entertainment?

Viscount Wolmer said the Government had accepted the recommendation of the Broadcasting Committee that the governing body should not be composed of persons representing various interests, but should be persons of judgment and independence. They would have every opportunity of technical and expert advice from advisory committees and the staff of the British Broadcasting Company which they would take over.



### Apparatus at the Bridgwater Receiving Station.

*Our title picture gives an accurate illustration of the receiving aerial and reflector system at the Bridgwater station.*

THE Bridgwater Beam Receiving Station is built on land situated near the village of North Petherton,  $2\frac{1}{2}$  miles south of Bridgwater, Somerset, the site being three-quarters of a mile from the main Bridgwater-Taunton road. It is about 60ft. above sea level, with open country around it in all directions, so there is no screening to interfere with the reception of signals.

#### Buildings.

The buildings are of brick, and are divided into two main sections—the engine room and the receiver room and offices—joined by a short covered passage. The continuity between these two sections is definitely broken, to avoid the transmission of vibration from the engines to the receivers.

Power is generated by two 18 h.p. Aster two-cylinder petrol-paraffin engines direct coupled to two Metropolitan-Vickers 10 kilowatt dynamos supplying power at 110 volts to the main switchboard, for charging the battery used for lighting the station, and for driving four motor generator sets manufactured by the Crypto Electrical Company. Two of these sets are for charging the four-cell filament batteries and two for charging the 110-cell anode batteries. The plant is thus duplicated throughout.

Adjoining the engine room are the station stores and station battery room. The station battery is a 60-cell battery by the Tudor Accumulator Co. of 132 ampere-hour capacity.

The filament and anode battery room contains two 760-ampere-hour four-cell filament batteries and two 30-ampere-hour 110-cell anode batteries by the Tudor Accumulator Company.

The receiver room is at the west end of the block. The receivers stand near the west wall where the feeders enter the building. At right angles to the receivers is a table for the recording apparatus and land-line instruments. The received signals are put direct to line, through A.T.M. high-speed relays, and, when required, can be checked for formation by means of undulators. A Wheatstone transmitter is also installed for testing purposes.

A Post Office omnibus sounder circuit connects the Central Radio Office, in London, with the Bridgwater and Bodmin stations for control purposes, and there are, in addition, two direct telegraph lines to London for the transmission of received signals to the C.R.O.

#### The Receivers.

The Bridgwater receivers are arranged for reception of signals from Canada on a wavelength of just over 26 metres. As an alternative, the receivers may receive signals from Canada on a different wavelength using the other aerial bay. The call letters of the Canadian transmitting station are CG.

The masts, receiving aerial, and feeder system are duplicates of those at the Bodmin beam transmitting station, except that the feeder tubes at the receiving station are slightly smaller than those at the transmitting station. The receiving masts are erected at right angles to the direction from which the signals are to be received, their exact orientation being: Canadian line of masts,  $158^{\circ} 13'$  W. of true North; South African line of masts,  $72^{\circ} 3'$  East of true North. The effect of the reflector wires is not only to screen the aerial from signals coming from behind, but also to reflect back to the aerial energy received from the front of the system. Providing that the

**The Wireless Beam.—**

incoming signal from the front of the system is of the wavelength for which the aerials and reflectors are tuned and spaced. the energy received upon the latter is reflected back on to the aerial exactly in phase with that directly induced. This affords a very considerable increase in the energy received as compared with a broadcast or non-directional aerial. By means of transformers and the special design of the feeder system, the energy of all the aerial wires is added and the total energy conveyed to the receivers, *via* the main feeder tubes, which terminate at what is known as a feeder unit of the receiver.

There are two Marconi short-wave beam receivers at Bridgwater, which are used for reception from two directions, namely, from Canada and from South Africa. In order to avoid interaction between the circuits, as they are worked on a common battery system, the frequency of the bands of the first filter amplifiers and the two second filter amplifiers, which will be described later, are suitably spaced. Otherwise the receivers are identical, and a description of one of them is given below. The complete receiver comprises nine units, each contained in a copper screened box to prevent interaction between them. the

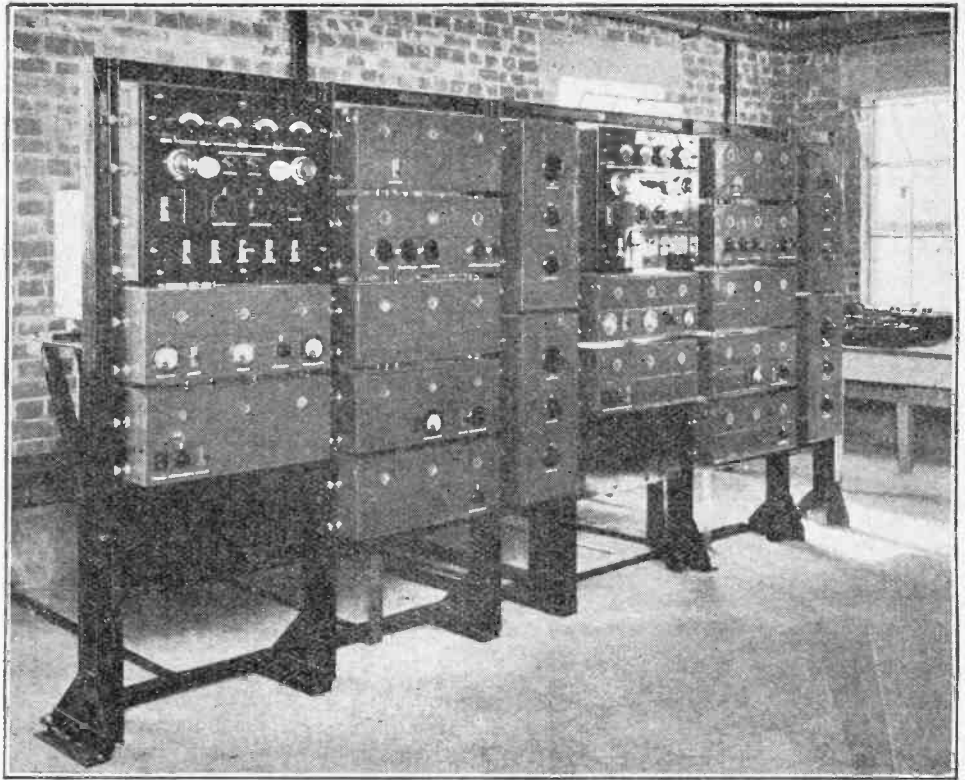

Control panels of the South African and Canadian receivers at Bridgwater.

general description of these units, the functions of which will be described below, being as follows:—

- (1) Feeder terminal unit.
- (2) Modulator.
- (3) Incoming short-wave circuits and first heterodyne.
- (4) First filter amplifier.
- (5) First rectifier, second heterodyne, and first listening circuit.
- (6) Second filter amplifier.
- (7) Additional second filter amplifier.
- (8) Main rectifier and second listening circuit.
- (9) Recorder and limiting circuits.

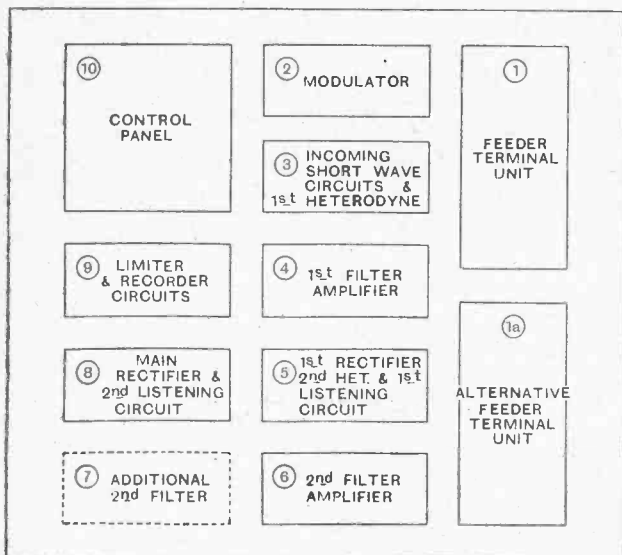

Diagrammatic explanation of the layout of the Canadian receiver which appears on the right of the receiver rack seen at the top of the page.

These units are mounted in a vertical iron rack or frame, and any unit can easily be changed if the need should arise. This method of mounting the units has the additional advantage of enabling the receivers to be adapted for any special purpose by the simple expedient of replacing one or more units without disturbing the general layout or the other parts of the set. The connections between the units are made at the back, and tuning controls are fitted on the front of the units, as well as switches and listening points which provide an audible check on the incoming signals. A control panel mounted on the left of each receiver enables the various voltages for the valves in circuit to be tested. A valve socket is provided to check the characteristics of any valve with the aid of the measuring instruments on the control board. The connections from filament and anode batteries as well as from the feeder are brought in at the back of each receiver.



**The Wireless Beam.—**

The receivers are so designed that their speed of working is only limited by the mechanical means of transmission and reception available.

The feeder terminal unit, at which the aerial system is joined to the receiver, has two low-loss tuned intermediate circuits, with a possibility of very weak coupling between them. This affords a means of obtaining additional selectivity and freedom from atmospheric and other interference. It is customary to work with very loose couplings in the unit, as, generally speaking, the signals are very powerful and the loose coupling facilitates the delivery of clear-cut signals to the lines connecting with the C.R.O., London.

The second intermediate circuit is coupled to the input circuit of the receiver through a variable coupling. This input circuit is tuned to the frequency of the incoming wave, and is connected to the grids of two modulating valves working in push-pull, *i.e.*, one grid is positive when the other is negative. These valves are of the L.S.5D type, the grids of which are taken in through the glass instead of the plug socket at the bottom, in order to keep down capacity effects on the short waves. The input valves and the filtering amplifier valves all work on the push-pull principle, as this gives perfectly stable and distortionless high-frequency amplification. Coupled to this circuit is the first heterodyne circuit, using one D.E.5 valve, which produces, with the incoming signal, a beat wave of about 1,600 metres. The signal on this new wave is subjected to three stages of high-frequency push-pull amplification. Each stage of amplification is dealt with by two D.E.5B valves working in push-pull, and these circuits have been so constructed that a constant amplification is obtained over a 10,000 cycle band, *i.e.*, 5,000 cycles on each side of the middle point. Outside this band the amplification is practically zero.

**Tuning Adjustments.**

When using the receiver the frequency of the first heterodyne is adjusted so that the beat which results, with the frequency of the incoming signal, corresponds to the middle frequency of the first band filter amplification. Consequently, if the frequency of the incoming wave varies within the limit of the band there will be no corresponding variation of energy at the output of the amplifier.

After the three stages of H. F. amplification the signals are rectified and again heterodyned. This second heterodyne can be used either for giving an audible beat frequency or for changing the wavelength of the signals up to about 10,000 metres. This change is effected by means of a switch which, when placed in the "audio" or closed position, enables the operator to listen to the incoming signals and to tune the initial circuits of the receiver. A milliammeter is connected in series with a telephone transformer in the anode supply to the rectifier valves which terminate at the first three stages of amplification. This is used as a check on the action of the second heterodyne, to measure the strength of the incoming signal, and to assist in adjusting the first heterodyne to the middle point of the band provided by the first amplifier.

On opening the heterodyne switch already mentioned the beat frequency of the signal is raised to about 30,000 cycles (about 10,000-metre wavelength), at which fre-

quency it is subjected to three more stages of high-frequency amplification. This second filter amplifier is similar to the first, except that the band is only 5,000 cycles wide. Normally, three stages of amplification are used for the second filter amplifier, but two additional stages may be added if necessary.

After the second amplifier the signals are again rectified by two L.S.5B valves, which are fed by a separate dry cell H. T. battery of 160 volts. The valves are set to the zero rectifying point by suitably biasing the grids with negative potential obtained from a dry cell battery and a potentiometer shunted across the 6-volt low-tension supply for final adjustment. A switching key is provided, by means of which the equivalent of a signal is obtained, this switch disconnecting the battery supplying the grid biasing voltage and connecting the grids directly to the negative side of the filament. In this way

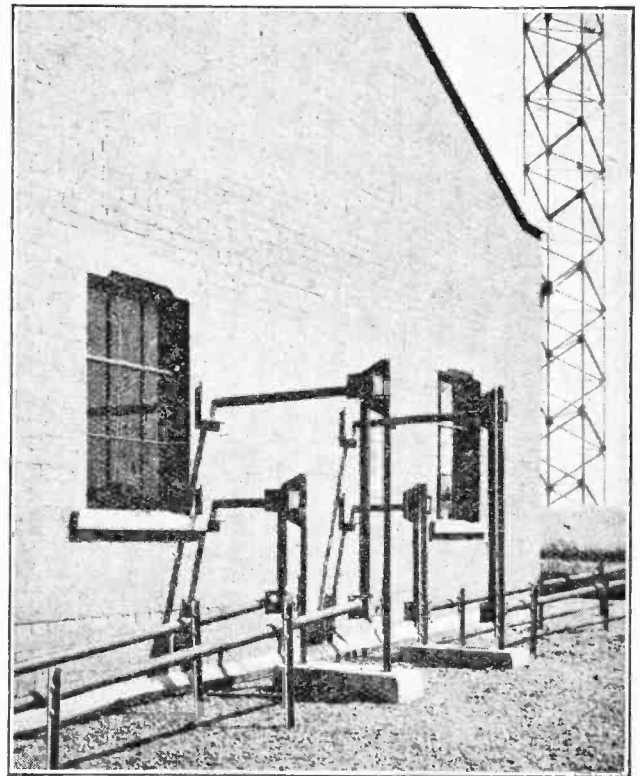

The feeder system for both aerial circuits leading into the receiving building.

a means is provided for testing the limiter and recorder circuits.

The outputs of the rectifier valves work in parallel into the limiting valve of the recording circuit through a milliammeter which indicates the signal strength and assists the attendant in adjusting the second heterodyne to the mid-point of the second filter amplifier band.

A part of the dry cell anode battery feeding the rectifier valves is used to provide the necessary positive potential to the grid of the limiting valve, which is adjusted to give about 3 to 4 milliamperes of plate current when the current in the plate circuit of the rectifier valve is zero. The effect of the incoming signals is to balance this positive potential. The minimum recording signal



**The Wireless Beam.—**

strength is that which reduces the plate current of the limiting valve to zero. Any signals of a greater intensity than this are mostly dissipated in a resistance so that the energy supplied to the D.C. bridge is constant.

The direct current bridge provides both marking and spacing current for operating a high speed "A.T.M." relay, which, in its turn, keys the Post Office land line to London, and, when required, a check undulator at the receiving station.

In order to provide a means of checking the signals when passing to line the following device has been adopted. The audible frequency oscillation of 1,200 cycles from a valve generator is superimposed on the first heterodyne, so that when the incoming signal is hetero-

dyned the resulting frequency passed through the first band filter amplifier has an audible note superimposed on it, and at the end of the circuit, after the final rectification, a single valve circuit tuned to this note frequency is coupled to the main circuit. By this means it is possible to listen to the signal, which gives a perfectly steady note of constant strength at two points without the necessity of using an oscillator at either point to give an audible beat frequency, even if the frequency of the incoming signals are varying, provided the variation does not cause the first beat frequency to alter so much that it occurs outside the band limits of the first filter amplifier.

The earthing arrangements for the receiver consist of a ring of six G.I. plates, spread round the western end of the receiver building at a radius of 50ft.

**General Notes.**

Mr. J. Clarricoats (G 6CL), Friem Barnét, writes:

"As a result of several months' work on the 45-metre band, I am forced to the conclusion that a large number of Continental stations give an exaggerated R strength.

"Many times recently I have received at 100% audibility stations whose signal strength has not exceeded R3, but have been reported R6 *myself* until I asked the question 'What is teler with you?' Then I invariably am told 'Sorry QSS QRM bad, etc.' Therefore it seems to me that it would help matters considerably if all amateur stations were to adopt some such form of question during transmissions—it would definitely prove how much was actually being received at the other station.

"The enquiry *re* weather seems to be very important, and is, in my opinion, more valuable than quality of signals. During the Low-power Tests I received several most interesting weather reports:—From Tolosa, Spain (strong gale); from SFV in the North Sea (terrific gale, heavy rain); from Copenhagen (cold, no rain); from Königsberg (fine, but cold); etc., etc.

"I would suggest, then, that the code letters WX? be used in communications as an indication that a weather report is desired.

"It is interesting to note that the time-wasting groups 'QRK?' and 'QSB?' are being superseded by the one brief 'HW?'

"Finally, I consider that all stations, when reporting reception, should specify the number of valves used, for reception reports without this information are very misleading."

We give this letter verbatim (except for translating a little unnecessary "Radiese" into plain English). We have in the past strongly urged the establishment of some code whereby transmitters may indicate the nature of the reports

desired, and we trust that this letter may be the means of advancing the matter towards a recognised International agreement.

Another point we would strongly urge is that transmitters should make a general practice of giving their *locality* with their call-signs whenever calling up or closing down.

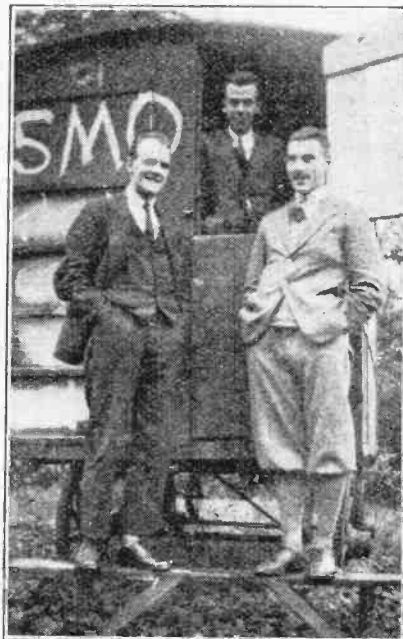

Mr. C. Morton's movable transmitting station GI 5MO at Belfast.

We reproduce a photograph sent by Mr. T. P. Allen (GI 6YW), of Belfast, showing a transmitting "shack" made out of an old caravan. The owner of this station, Mr. C. Morton (GI 5MO) is seen inside with 6YW and Mr. W. Davison (5WD) on either side of the doorway.

o o o o

A correspondent in Barrow-in-Furness states that on Saturday, November 6th, U 2XAF was coming over with wonderful strength, and from 11.30 p.m. G.M.T. to 1.30 a.m. on Sunday he was entertained with some delightful musical items. He had previously heard Königswusterhausen on 58 metres on the loud-speaker, using an 0-v-2 receiver. At 1.30 a.m. KDKA on 61 metres was also fairly clear but not at anything like the strength of 2XAF. He noticed a quick and regular fading effect, which he describes as "a continuous surge of about 1 to 1½ seconds' periodicity, not troublesome when signals are strong, but very disconcerting when weak."

o o o o

**Reception of American Broadcasting.**

In view of the interest now taken in the reception of American broadcasting, we give below a list of the 15 stations controlled by the General Electric Co., Schenectady:—

WGY	370.5 metres.
2XAC	30 to 150 metres.
2XAD	10 to 50 metres.
2XAF	110 metres.
2XAF	10 to 50 metres.
2XAG	380 metres (50 kW).
2XAH	1,000 to 4,000 metres.
2XAK	100 to 200 metres.
2XAM	110 metres.
2XAW	3 to 20 metres.
2XAZ	100 to 200 metres.
2XH	50 to 150 metres.
2XI	All wavelengths.
2XK	150 metres.
2XO	10 to 50 metres.

o o o o

**QRA's Wanted.**

G 2JO, G 5QP, G 6LH, G 2AWJ, A 2SH, GW 3XO.

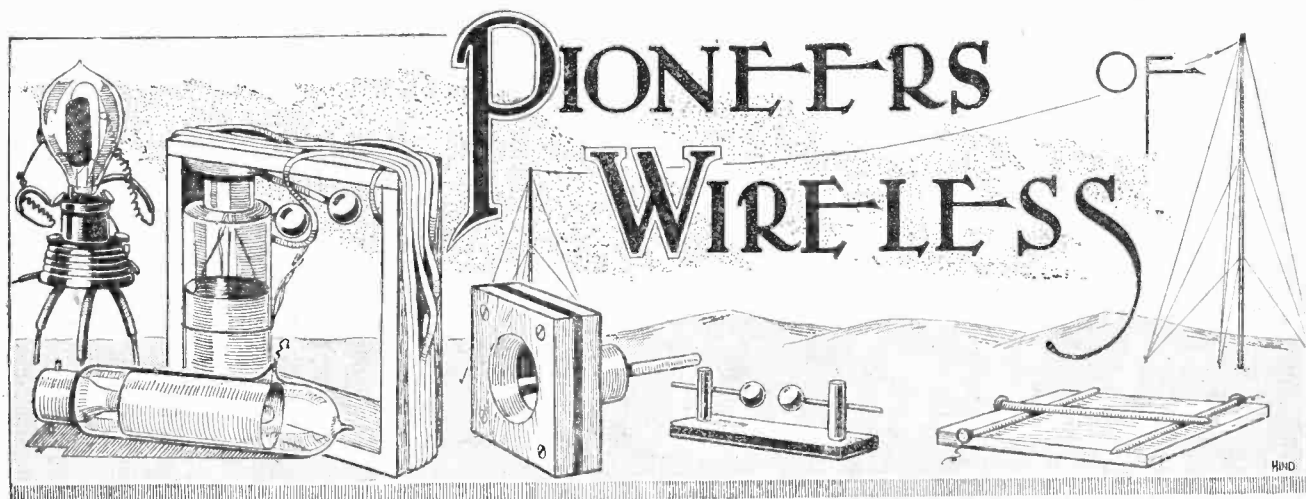

### 36.—Fessenden, Pioneer of the Wireless Telephone.

By ELLISON HAWKS, F.R.A.S.

OUR story of the pioneers of wireless is now all but told. We have traced the subject, from the earliest times to Marconi's conquest of the Atlantic, by means of the men who have done so much—and, for the most part, gained so little—to benefit their fellow creatures. Our story would be incomplete, however, were we to make no mention of the pioneer efforts to perfect wireless telephony—the transmission of speech as distinct from wireless telegraphy, the transmission of the dot-and-dash of the Morse code.

#### The Problem of Wireless Telephony.

Although wireless telegraphy certainly laid the foundation for the wireless transmission of speech, the problem offered by the latter objective is very different and infinitely more elusive. We can make this more clear by briefly reviewing the nature of the underlying principles—well-known, no doubt, to the majority of our readers—and by recapitulating the problem that the pioneers of wireless telephony, without any guiding precedents, had to solve.

In the first place, wireless telephony depended on the invention of some apparatus that would propagate undamped, continuous electric waves at radio-frequency. This has been made possible in modern practice, of course, by three separate inventions (1) the Poulsen arc (2) the high-frequency alternator, and (3) the thermionic valve. The variations in the current, as

used in line-telephony, are of too low a frequency to cause electromagnetic waves in the ether, and are not sufficiently powerful. To overcome these difficulties a "carrier wave" is employed, formed by the emission of undamped, high-frequency oscillations of constant amplitude. As in line-telephony, a transmitter is introduced in the circuit and impresses the variations caused by the voice on the carrier wave. These superimposed on the oscillations of the carrier wave cause it to vary in strength, according to the sounds transmitted.

These principles were fully realised by those who attacked the problem and of these probably Fessenden may be regarded as the pioneer.



Reginald Aubrey Fessenden.

Reginald Aubrey Fessenden was born on October 6th, 1866, at Milton, Quebec, his father being Rev. E. J. Fessenden. Young Fessenden was educated at Bishop's College, Port of Quebec, and was appointed Principal of the Whitney Institute, Bermuda, 1885-86. He was Inspecting Engineer for the Edison machine works 1886, and in 1887 became head chemist at the Edison Laboratories. Three years later he was appointed electrician to the Westinghouse Co., where he remained until elected Professor of Electrical Engineering at Purdue University, 1892. The following year he became Professor of Engineering at the University of Pittsburg, where he remained until appointed General Manager of the National Electric Signalling Co. in 1902.

It was in 1892 that he first

**Pioneers of Wireless.—**

studied Hertzian waves at Purdue University, and from that time to the present his work in connection with wireless has been unceasing.

At first he endeavoured to transmit speech by the old spark-gap method, but soon found it was impossible to do so. Recognising that a continuous wave was the first necessity in radiotelephony he set to work (in 1898) to endeavour to produce a continuous wave, first by commutating a continuous current, then by a continuous arc, and lastly by a high-frequency dynamo.

**Early Successes.**

In 1900 he succeeded in first transmitting speech by wireless over a distance of a mile at Cobb Point, Maryland, using a commutator that gave 10,000 cycles per second. The articulation of the transmitted speech was not clear, however, and continuing his experiments he obtained better results two years later by the continuous arc method. Using a frequency of 50,000 cycles per second he was able to transmit clearly articulated speech for distances up to 12 miles. In 1903 he had increased the range up to 25 miles, and carried out public demonstrations at Washington.

In the meantime he developed a high-frequency alternator, and finally installed three dynamos at Brant Rock, Mass., two of which operated at 50,000 cycles and a third at 100,000 cycles per second.

Instead of the Branly type coherer, which had to be tapped back every time a signal was received, he invented several devices, the first of which was the ring receiver mounted on a sensitive microphonic contact, followed by the hot-wire barretter and the liquid barretter. He also devised an interesting type of receiver in which a small hot-wire barretter mounted on a small rubber holder fitted inside the ear. In this instrument the telephonic variations of current cause variations in the temperature of an extremely fine filament of wire or foil which cause corresponding expansions in the surrounding air. These expansions follow the heating effects in the wire so closely that faithful sound reproduction of the telephonic currents is assured. Invisible wires ran to the hat-band and down the side of the body, permitting wireless telephone messages to be received by a person walking about in the fields several miles from a station.

**Connection with Land-lines.**

In 1906 Fessenden transmitted successfully between Brant Rock and Plymouth and relayed conversation over the land lines, successfully demonstrating the possibility of connecting a land telephone line to a wireless telephone station. "As it is realised," he said in a lecture in 1908 before the American Institute of Electrical Engineers, "that the use of wireless telephony would be seriously curtailed unless it could be operated in conjunction with wire lines, telephone relays were invented, both for receiving and transmitting ends. These were found to operate satisfactorily, speech being transmitted over a wire line to the station at Brant Rock and retransmitted from there wirelessly by a telephone relay, received wirelessly at Plymouth, and there relayed out again on another wire line."

Fessenden also maintained regular wireless conver-

sation between Brant Rock and Jamaica, Long Island, a distance of 200 miles, with articulation that was stated to be clearer than that on the land lines between the two places. In 1907 he invented an apparatus that permitted simultaneous talking and listening.

It is interesting to note that Fessenden claims to have been the first to transmit speech across the Atlantic, although this was not an intentional transmission. The incident occurred in November, 1906, when his operators telephoning between Brant Rock and Plymouth were overheard on several occasions by operators at Machrihanish, Scotland. They not only identified the voices of the men speaking, but sent back several reports giving the exact words of the conversations, which were subsequently verified by the log books of the station.

As a result of tests made by the Bell Telephone Co. a contract was entered into in 1908 for the construction of wireless installations to work between Boston, New York, Buffalo, and Washington. The contracts were not carried out because the financiers of the Bell Telephone Co. decided that the company was expanding too rapidly. In consequence of this revision of policy wireless telephony for commercial use was delayed for about a dozen years.

Fessenden brought out an ingenious method of overcoming cross talk, the publication of which was at the time of its discovery (1915) forbidden by the Government on account of the war. The method consists of splitting speech into a spectrum band and transmitting each element of the speech spectrum separately, then re-assembling the elements at the receiving end. In practice each subscriber would be given a number in the wireless directory, and on turning the indicator to the figures of the call of the person to whom he wishes to talk and throwing the switch, the caller will find himself in direct communication with the person called.

**Fessenden's Numerous Activities.**

Incidentally it may be mentioned that Fessenden claims credit for the invention of the radio compass and many other inventions not connected with radio, including the smoke cloud for tanks, the electrically-driven battleship, and the location of enemy artillery by sound ranging. He has recently invented a high-frequency alternator which, although only 6 inches in outside diameter, delivers  $\frac{1}{4}$  h.p. at 50,000 cycles. Television has also occupied his attention, and a short time ago it was stated that he is at present at work perfecting an apparatus with which "it will be possible to point a radio camera, connected to an aerial at the steps of the Capitol in Washington, and by so doing enable every radio subscriber actually to see senators at debate in congress. Every gesture will be visible, and in addition the speech will be heard by means of the radio telephone. With the experimental instrument already constructed the size of the picture is limited to 4ft. x 4ft. on a screen 12ft. distant or 4in. x 4in. on a screen 12in. distant. The coarse-graininess of the image at a distance of 12in. corresponds to the 50 dot per inch process plate photo."

**NEXT INSTALMENT.**

Edison Paves the Way for the Valve.



## CLUB REPORTS AND TOPICS

### Sea Secrets.

Mysteries of submarine telephony were disclosed at the last meeting of the Wireless and Experimental Association (Peckham), the lecturer being a representative of Messrs. Siebe Gorman & Co.

A fascinating description was given of the use of wireless in the detection of enemy submarines and in determining the depths of oceans. A diver related some of his experiences, and members had an opportunity of testing a complete telephony equipment for communication between two divers.

Hon secretary: Mr. F. W. Kendall, 22, The Park, Mitcham, Surrey.

o o o o

### Transmitter Efficiency.

Lecturing before the North London Experimental Radio Society on November 4th, Mr. L. H. Bedford (of Standard Telephones and Cables, Ltd.) dealt with valve oscillators, and explained how the Hartley circuit, by the substitution of condensers for the inductances and an inductance for the condenser, was evolved into the Colpitts arrangement.

In the course of some useful remarks on transmitter efficiency, the speaker referred to the necessity of avoiding too high a plate current when the plate voltage is low. The means to this end was a very high negative grid bias and a high feed back to compensate. Mr. Bedford stated that by an application of this principle the efficiency of a set could be raised to 80 per cent. from the average of 50.

o o o o

### Cutting Out Interference.

"A Members Night" provided an interesting programme at the last meeting of the South Manchester Wireless Society, when various members gave 10-minute talks on divers subjects.

The society has recently been troubled by interference from electrical apparatus in a local picture theatre, but the annoyance has now been overcome by connecting two  $\mu$ F condensers across the mains of the theatre generator and earthing the centre point between the two condensers.

The society's headquarters are at the Didsbury Institute, Elm Grove, Didsbury, where meetings are held every Monday at 8 p.m. Visitors are cordially invited. Full particulars of membership can be obtained from the hon. secretary, Mr. G. F. Mercer, 5, Ruabon Road, Didsbury.

o o o o

### Southport Show Novelties.

The Southport and District Radio Society has been well repaid for its effort in organising the second annual Wireless Exhibition, which was held in the Temperance Hall, Southport, on October 28th, 29th and 30th. In addition to a large increase in club funds, the exhibition has greatly enlarged the membership and pro-

*Secretaries of Local Clubs are invited to send in for publication club news of general interest. All photographs published will be paid for.*

moted greater interest in wireless throughout the district.

Local wireless dealers responded in a splendid way, the stands being most attractive with their comprehensive display of the season's latest apparatus.

A feature of the exhibition was a miniature broadcasting station built in the gallery, complete with studio, microphone and amplifiers. Parties of eight were taken round every fifteen minutes, and the guide had a very arduous time explaining the functions of the apparatus!

Over 3,000 people visited the exhibition.

Hon. secretary: Mr. T. Godfrey Story, 67, Virginia Street, Southport.

o o o o

### Logging Distant Stations.

Friends of the Muswell Hill and District Radio Society will be pleased to

### FORTHCOMING EVENTS.

#### WEDNESDAY, NOVEMBER 24th.

Radio Society of Great Britain.—  
Ordinary Meeting. At 6 p.m. (tea at 5.10). At the Institution of Electrical Engineers, Savoy Place, W.C.2.  
Lecture: "Quartz Crystals and Practical Circuits," by Mr. A. Hinderlich, M.A.

Tottenham Wireless Society.—At 8 p.m. At the Institute, 10, Bruce Grove, N.17.  
Demonstration and Lecture: "Recent Developments in Radio Reception," by Mr. J. H. Heyner, B.Sc.

Barnsley and District Wireless Association.—At 8 p.m. At Headquarters, 22, Market Street, Barnsley. Lecture and Demonstration: "Comparison Between Resistance-coupled and Transformer-coupled L.F. Amplifiers." Lecturer: Mr. J. Ridgway.

Muswell Hill and District Radio Society.—At 8 p.m. At Tollington School, Tetherdown, N.10. Lecture: "Developments in Valves for Broadcasting," by Mr. E. E. Henderson (G.E. Co.).

#### THURSDAY, NOVEMBER 25th.

Preston and District Radio Research Society.—Lecture: "Behind the Scenes in Broadcasting," by Mr. E. Liveing, Station Director of 2ZY.

#### FRIDAY, NOVEMBER 26th.

Bristol and District Radio Society.—Lecture and Demonstration of Radio Apparatus by the G.E. Co.

Leeds Radio Society.—At 8 p.m. At Collins's Café, Wellington Street. Lecture by Mr. J. Ewles, M.A.

Sheffield and District Wireless Society.—Experimental Work.

#### MONDAY, NOVEMBER 29th.

Southport and District Radio Society.—Annual General Meeting.

Croydon Wireless and Physical Society.—At 8 p.m. At 122a, George Street. Informal Talk on "Rectification of Alternating Current," by Mr. Arthur J. Webb, M.A.

know that the society is making very rapid and definite headway, and the membership now totals well over fifty.

On the evening of November 10th, at the headquarters, Tollington School, Muswell Hill, a large audience listened to a demonstration of a new six-valve set, on which twenty-eight stations were received in a few minutes. Lack of clarity from most stations was compensated by the number and volume of distant stations heard. Stations in Czecho-Slovakia and Austria were very good, and all were received by turning one wheel only.

Membership particulars and the syllabus will be posted by return on application to the hon. secretary, Mr. S. S. Sessions, 20, Grasmere Road, N.10.

o o o o

### Getting the Best from Loud-speakers.

Faithful reproduction by loud-speaker was the subject discussed by Mr. R. H. Morgans at the last meeting of the Sheffield and District Wireless Society. The speaker paid special attention to the points which arise in designing an instrument intended to reproduce faithfully in the form of sound waves the varying currents from the receiving set. Speakers of the horn and hornless type were reviewed, and a practical demonstration of both types was given, which showed the necessity for using a correctly designed L.F. amplifier with any loud-speaker and exhibited the harmful effects of overloading.

Hon. secretary: Mr. T. A. W. Blower, 129, Ringinglow Road, Sheffield.

o o o o

### The Social Side.

Variety in the shape of an informal social evening provided an enjoyable meeting of the Bristol and District Radio Society at Hort's Restaurant, on November 12th, when various members and lady friends entertained the company with songs, violin solos, card tricks and yarns.

At the society's next meeting, on November 26th, a lecture and demonstration of radio apparatus will be given by the General Electric Co., Ltd.

Hon. secretary: Mr. S. J. Hurley, 46, Cotswold Road, Bedminster, Bristol.

o o o o

### The "Straight Eight."

The well-known "Straight Eight" set formed the subject of an interesting demonstration at the November 10th meeting of the Wireless and Experimental Association (Peckham), the lecturer being a representative of the Marconiphone Co., Ltd.

This evening (Wednesday) a lantern lecture on "Valves" will be given by a representative of the G.E. Co. The meeting will be held at 8 p.m. at the Camberwell Central Library, Peckham.



Brain Waves of the Wireless Engineer.

**A Peculiar Valve Amplifier.**  
(No. 256,998.)

Application date, March 21st, 1925.

A most peculiar amplifier circuit is claimed by J. Wilcockson and H. W. Roberts in the above British patent. The circuit is a three-valve arrangement. A tuned circuit  $L_1, C_1$  provided with aerial and earth connections is connected between the grid and filament of the first valve  $V_1$  through

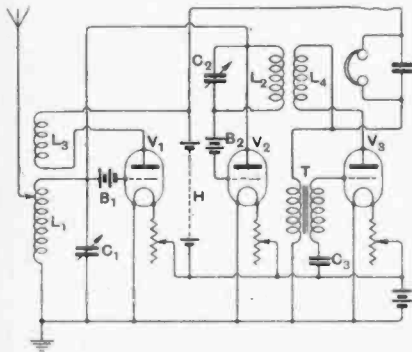

Three-valve receiver-amplifier.  
(No. 256,998.)

a bias battery  $B_1$ , which gives the grid a negative potential. The anode circuit of this valve contains a reaction coil  $L_2$ . Another tuned circuit  $L_2, C_2$  is connected between the anode and the grid of the second valve  $V_2$ , a battery  $B_2$  being included in the grid connection of this valve. The upper end of the tuned circuit  $L_2, C_2$  is also connected to the anode of this valve. The inductance  $L_2$  is coupled to another inductance  $L_3$  connected between the anode and the third valve  $V_3$ , and the primary winding of an intervalve transformer  $T$ . The other end of this primary winding is connected

to earth. The telephone receivers are connected between the positive side of the high-tension battery  $H$  and the inductance  $L_4$ . The specification states that the valves are used as high-frequency and low-frequency amplifiers, some form of reflex action taking place.

o o o

**Stabilising High-frequency Amplifiers.**  
(No. 237,553.)

Convention date (U.S.A.), July 26th, 1924.

A method of stabilising high-frequency amplification, which does not result in any material reduction of sharpness of tuning, is described in the above British patent, No. 237,553 by Atwater Kent Manufacturing Company and A. D. Silva. The novelty of the invention lies essentially in the inclusion of a resistance between the grids of the valves and the tuned circuits to which they are connected. It is well known that when the grid circuit of a valve is connected to a critically tuned oscillatory circuit, and when the anode contains an impedance or another tuned circuit adjusted to the same frequency as that connected between the grid and filament, there is a very strong tendency for oscillation to occur owing to the capacitive coupling between the two circuits. The accompanying diagram illustrates the invention, in which it will be seen that the valves contain tuned circuits LC. The valves are coupled together by high-frequency transformers HF, of which the tuned circuits LC form secondaries. Inherent capacitive couplings between the anodes and grids are shown at K. Between the grids and high potential ends of the tuned circuits LC are connected resistances R, which may be of the order of about 500 ohms. Thus it will be seen that the effect of a tuned circuit in the

anode circuit, or coupled to the anode circuit, can only be transferred to the input tuned circuit through the capacity of the valve which is now in series with the resistance. This, of course, considerably lowers any transferred voltage, and successfully stabilises the amplifier. The inclusion of the resistance R between the grid and the end of the tuned circuits does not lower the sharpness of the tuning of that circuit, but, on the other hand, tends to lower the overall amplification.

o o o

**A Choke Coupling Unit.**  
(No. 257,003.)

Application date, May 16th, 1925.

The construction of a very compact form of choke coupling unit is described by L. M. Robinson in the above British patent, and should be of interest to experimenters. The invention consists in

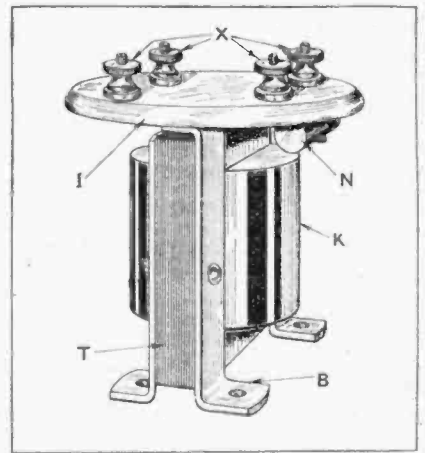

Choke coupling unit. (No. 257,003.)

associating a choke, a coupling condenser, and a grid leak in a very compact form, which is illustrated in the diagram. The choke is wound upon a shell type transformer core T, in the form of an ordinary bobbin. A top plate of insulating material I is fixed to the core, which is clamped together by brackets B, the top plate I carrying four terminals X. The coupling condenser consists of foil and mica, which is wrapped round the bobbin, the whole being kept in position and protected by a covering K. The grid leak is placed in a tube N, which is held in a clamp, fixed to the side of the insulating plate I.

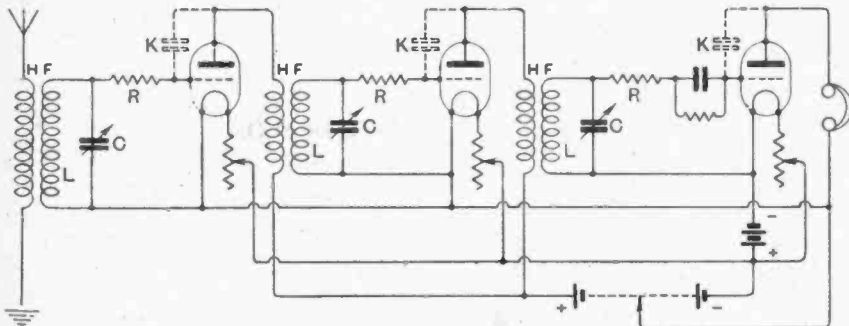

Resistance-stabilised H.F. amplifier (No. 237,553.)



# A Note on DETECTOR VALVE EFFICIENCY.

## Ratio of Modulated H.F. Input to L.F. Output for an Anode Rectifier.

RECENT advances in the design of H.F. transformers have naturally brought with them improved methods of H.F. measurement, and it is possible to state with accuracy the amplification per stage of valve-transformer combinations.<sup>1</sup> Similarly, in the case of low-frequency transformers, the manufacturers of the best examples not only publish curves showing the amplification per stage at any frequency, but in some cases guarantee that the results given by their production transformers do not differ from the stated values by more than 5 per cent.

Valuable as this information is, it yet does not enable us to state the overall amplification of a receiver, neither can we from a knowledge of the H.F. and L.F. amplification alone design a receiver that will deliver a L.F. amplitude of, say, 10 volts to the power valve for an input amplitude from the aerial of, say, 0.1 volt modulated H.F.

The results set forth in the table, although derived under one set of conditions only, will no doubt serve as an indication of the L.F./H.F. ratio to be expected in the B.B.C. transmissions with an anode bend rectifier.

The circuit diagram (Fig. 1) shows the arrangement of apparatus used in the tests. The first valve is the detector under test and the second valve a low-frequency amplifier in the anode circuit of which a loud-speaker is connected for making aural observations of tuning and quality. To simplify the voltmeter connections a single grid-bias battery is used for both valves.

### Preliminary Adjustments.

The procedure in adjusting the grid bias and H.T. voltages is as follows: Choose from the valve curves a suitable anode voltage for the detector and adjust grid bias until best results are obtained (judged either aurally or by a series of preliminary comparative readings of H.F. input and L.F. output). Having disposed of the detector, look up the valve curves of the amplifying valve and choose a curve for which the grid bias is correct under amplifying conditions. Then apply the H.T. voltage corresponding to this curve. The actual values used in the test will serve as an example to illustrate this point. The valves were of the D.E.2 H.F. and D.E.2 L.F. types respectively, and it was decided to use an anode voltage of 72 for the detector. The grid bias that gave best results with this detector anode voltage was -6 volts. An anode voltage of 100 was therefore applied to the second valve, since this corresponds to a grid bias of -6 volts for amplifying conditions.

The H.F. and L.F. input and output amplitudes were measured with a calibrated valve voltmeter, a system of Clix plugs and sockets being arranged to connect the voltmeter either between grid and filament of the detector valve or across the secondary of the coupling transformer. The centre socket is for shorting the grid-filament circuit of the voltmeter when not in use.

The voltmeter valve operates as an anode rectifier and does not appreciably load the circuits with which it is associated. It was found, however, that slight retuning was necessary when it was transferred from the input circuit to the output circuit. The readjustment of tuning was made aurally, and any error introduced may be neglected for the purpose of this test.

A tapped aerial tuning inductance is used to reduce the input amplitude to readable values, since the test was carried out only 4 miles from 2LO.

A transformer is the simplest method of eliminating the steady anode current when measuring the L.F. output. A Ferranti A.F.3 transformer having a turns ratio of 1 to 3.5 was used. At the frequency of the B.B.C. tuning note, the voltage step-up between primary and secondary is equal to the turns ratio, therefore, by dividing the volts across the secondary by the turns ratio we obtain the R.M.S. value of the L.F. output amplitude.

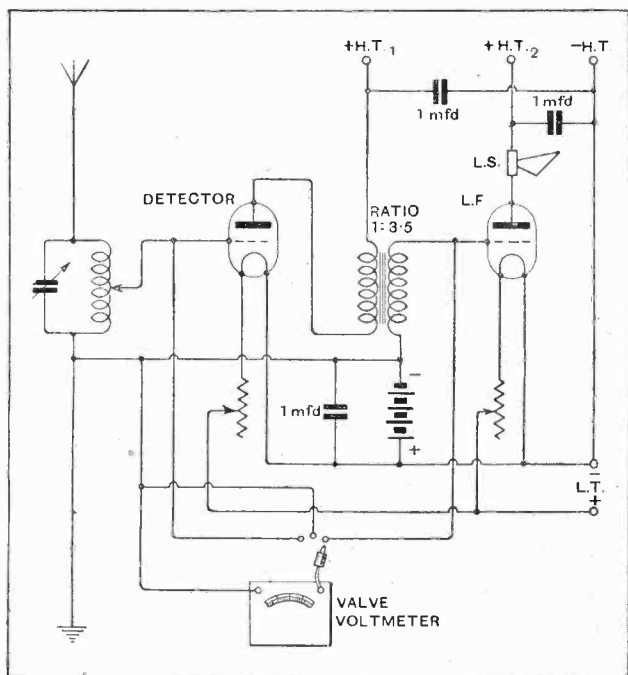

Fig. 1.—Circuit diagram of apparatus used for detector valve tests.

The key to the situation is the detector valve. At this stage the H.F. and L.F. components of the modulated wave are separated, and if we can state the relation between the H.F. input to the detector and the L.F. output delivered to the first L.F. valve we can easily fill the gaps between the aerial circuit and the grid of the power valve with an adequate number of stages both of high- and low-frequency amplification.

<sup>1</sup> *The Wireless World*, July 28th, 1926, page 113.

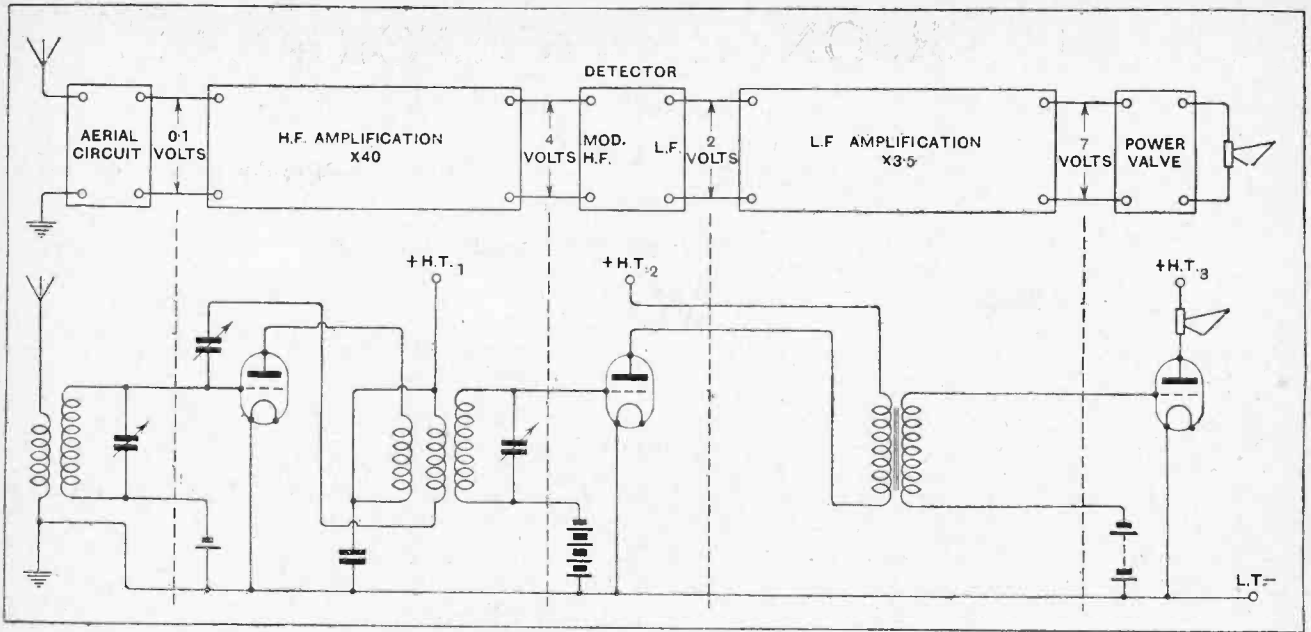

Fig. 2.—Example of receiver design based on data obtained from the detector experiments.

The first column of figures in the table indicates the H.F. amplitudes applied to the detector. These values are quite easy to read, as the percentage modulation at 2LO is so small that no visible change of amplitude takes place when the microphone is in use. When reading the L.F. voltages, however, some skill is required in estimating the probable average amplitude except in the case of the tuning note, which remains quite steady after the preliminary adjustments at the station. The figures in the second column represent the maximum *sustained* voltages recorded throughout each item.

The third column is obtained by dividing the transformer secondary volts by 3.5, and the final column shows the ratio of H.F. input to L.F. output. The latter values also represent the actual L.F. volts in the detector anode circuit for an H.F. input amplitude of one volt.

**A Typical Design.**

Fig. 2 illustrates the method of applying these results to an ordinary receiver. Let us retain the D.E.2 H.F. as detector under the conditions used in the test. This valve is capable of dealing with inputs up to 6 volts (peak value), and will operate most efficiently with large amplitudes, so we will work on 6 volts as a basis. The R.M.S. value equivalent to this is 4.2—let us say, 4 volts. Therefore we must arrange for forty-fold amplification at high frequency to secure 4 volts on the detector from the 0.1 volt input from the aerial. This will be given by a single stage efficiently designed.

The L.F. output obtained from the 4 volts applied to the detector is 2 volts, taking 0.5 as an average value for the L.F./H.F. ratio. This has to be amplified to 7 volts for application to the loud-speaker power valve. This will be given by the voltage step-up of a 1 : 3.5 ratio transformer without the use of an additional valve. A R.M.S. input of 7 volts to the power valve is equivalent to a peak value of 10 volts, and is suitable for applying to the usual power valve with a negative grid bias of

9 or 10 volts. This input will give a volume of sound adequate for the average dwelling-room.

One or two points arising as side issues from this investigation may be mentioned in conclusion. The higher the degree of L.F. amplification between the detector and the power valve the lower must the input to the detector be reduced if the power valve is not to be overloaded. But it is generally agreed that the efficiency of an anode bend rectifier falls off as the input amplitude is decreased. It therefore follows that best results will be obtained with a certain fixed degree of L.F. amplification, and that volume control should not be obtained by switching out stages of the L.F. amplifier, but by varying the degree of H.F. amplification between the aerial and the detector valve.

TABLE.

DATE: JULY 19TH, 1926. VALVE: DE2 H.F.  
 STATION: 2LO ANODE VOLTS: 72  
 WAVELENGTH: 365 METRES. GRID VOLTS: -6

Item.	H.F. Input (Volts, R.M.S.)	L.F. (Secondary) (Volts, R.M.S.)	L.F. Output (Primary) (Volts, R.M.S.)	L.F./H.F. ratio.
Tuning Note ...	3.5	6.5	1.85	0.53
Big Ben (Hour Strokes) .....	2.95	5.5	1.57	0.53
String Quartet .	2.6	4.6	1.3	0.50
	2.7	3.9	1.1	0.41
	3.0	4.5	1.3	0.43
Soprano and Quartet .....	2.55	4.9	1.4	0.55
	2.7	5.1	1.45	0.54
Soprano and Piano.....	2.35	4.1	1.17	0.50
Solo Pianoforte .	2.35	3.5	1.0	0.43
Talk.....	2.6	3.5	1.0	0.38
News Bulletin ..	2.3	2.0	0.57	0.25
	2.6	2.5	0.7	0.27

# SUPERSONIC TRANSFORMERS.

## PART III.

### Measurement of Primary Inductance, Effective Primary Capacity and Optimum Wavelength.

By N. W. McLACHLAN, D.Sc., M.I.E.E., F.Inst.P.

THESE quantities should be measured as far as possible under actual working conditions, or the results may be misleading. For example, measurements with a buzzer, telephones, and crystal are often wide of the mark, and as the tuning is extremely flat it is easy to incorporate appreciable errors. In general, I have found the natural wavelength too short when using a buzzer. It is possible that the polarising current due to the anode feed, especially with valves of low internal resistance and a fair H.T. voltage, may increase the differential permeability of the iron. Also the magnetisation in one case is by damped waves, whereas in the other the magnetisation is by a steady alternating current. The most important factor, however, is associated with the inter-connection in the valve circuit as explained below.

The optimum wavelength is readily found from the amplification curves, and this is, to a first approximation, the natural wavelength of the transformer.<sup>1</sup> The difference between the two is bound up in an intricate mathematical expression which we need not discuss here. Taking a high-impedance valve such as a D.E. 8 H.F., or a D.E. 5B., the amplification curve has a relatively pronounced peak, so that the optimum is more readily found than it would be with a low-impedance valve, say, a D.E. 5. The oscillator is set to the optimum wavelength and a variable condenser connected across the primary of the transformer. When this condenser is moved from zero (the condenser used had practically zero initial value on the scale) the magnification should not increase. If the optimum has been found correctly, the magnification, as indicated by the ammeter (A) of valve  $V_3$  in Fig. 5, will decrease with increase in capacity. The wavelength of the oscillator is increased to some suitable value, and the variable condenser adjusted to give maximum amplification, i.e., maximum reading of (A). This is a new optimum, and the reactance of transformer and condenser combined is again zero. If desired, another optimum of still greater wavelength can be found. The self-capacity of the transformer

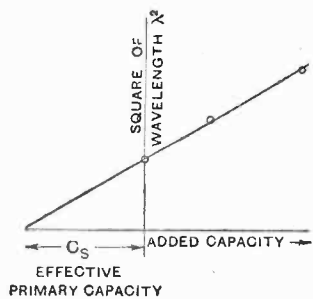

Fig. 16.—Method of determining effective capacity of primary winding.

is found by plotting the added capacity against the square of the wavelength, as shown in Fig. 16. The intercept on the horizontal axis is the effective capacity

<sup>1</sup> The wavelength here includes the effect of the extra secondary capacity due to  $V_2$  in Fig. 5.

of the primary of the transformer. It is approximately equal to  $C_s = \text{primary self-capacity} + (\text{ratio})^2 \times C$ , where  $C$  is a composite capacity due to the secondary and the mutual capacity between primary and secondary. Having found  $C_s$ , the primary inductance is calculated from the optimum wavelength by aid of the familiar expression  $\lambda = 1885 \sqrt{L_1 C_s}$ , where  $L_1$  is in microhenries, and  $C_s$  in microfarads. Data for some of the transformers tested are set out in Table V.

TABLE V.  
PRIMARY EFFECTIVE CAPACITY AND INDUCTANCE.

Transformer.	$C_s$ (Micro-microfarads).	$L_1$ (Microhenries).	$\lambda$ Opt. (Metres).	$f$ Opt. (Cycles).	Equivalent Secondary Capacity (Micro-microfarads).
No. 1	500	$2.4 \times 10^4$	7,000	$4.3 \times 10^4$	$\frac{560}{9} = 62$
No. 2	1,000	$2.3 \times 10^4$	9,000	$3.35 \times 10^4$	$\frac{1000}{16} = 62$

A series of measurements of self and mutual capacities were conducted with the windings of the transformer quite separate. These are given in Table VI, the conditions of measurement being stated. The method of measurement was only an approximate one, namely, to use the winding of the transformer as a condenser at a very short wavelength (100 metres), and find its value by substitution (see Fig. 17). It will be seen that the disposition of the windings, i.e., whether I.P. and I.S. or I.P. and O.S. are at the same end of the core, makes no difference in the self capacity, but a large difference

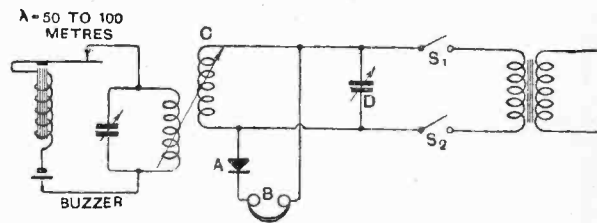

Fig. 17.—Arrangement for approximate determination of various capacities of a transformer by substitution. C=pick-up coil, D=calibrated variable condenser, A=high resistance crystal or valve detector, B=high resistance phones,  $S_1, S_2$ =switches for isolating transformer on test.

in the mutual capacity. This is hardly beyond the bounds of expectation. In practice, where the transformer is used in a valve circuit, the windings are not entirely separate, for it is usual to connect I.P. to +H.T. and I.S. to grid bias negative. So far as alternating current is concerned, these two points are at the same potential and may be regarded as directly connected together. Thus the capacity relationships of the transformer will differ

Supersonic Transformers, Part III—

from those when the measurements are made external to the valve circuit with a buzzer. Furthermore, it is of interest to remark that when the above mode of valve circuit connection is changed to, say, O.P. to +H.T. and I.S. to grid bias negative (as before), the optimum wavelength is augmented, due to the increase in the effective self-capacity of the primary. This is sometimes a useful trick when several transformers are used in cascade and oscillation ensues. By altering the optimum wavelength of one of the transformers, the condition for oscillation is sometimes violated and peace reigns supreme. In addition, this artifice may be used to broaden the overall wave band of the combination. With transformer No. 3 the variation (increase) in wavelength due to connecting the secondary inner instead of O.S. to grid was about 6 per cent.<sup>2</sup> The windings in this case were arranged as shown at B in Table VI.

TABLE VI.

CAPACITIES OF NO. 1 TRANSFORMER FOUND BY BUZZER METHOD AT  $\lambda=100$  m.

Capacity (Micro-microfd.)		Where Measured.	Remarks.	Transformer and Arrangement of Windings.	
A	B			A	B
7	7	I.S.—O.S.	Self-capacity	$3/1 = \frac{900}{300}$ : the windings being separated, i.e., not connected.	→ As in A
7	7	I.P.—O.P.	"		
10	40	I.P.—I.S.	Mutual Across		
20	18	O.P.—I.S.	" Adjacent		
22	14	I.P.—O.S.	"		
10	35	O.P.—O.S.	" Across		

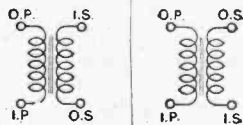

Polarisation and Change of Wavelength.

We have already shown that in general the optimum wavelength is slightly greater when the transformer is used in a valve circuit with a polarising current than otherwise. There is another and a somewhat deadly polarisation, which can occur. For a manufactured article—an amplifier is intended—whose connections will “stay put,” there is little fear of trouble, but if in conducting experimental work the grid lead when removed should come in contact with the +H.T. terminal, the H.T. battery will send a large current through the secondary winding and drive the iron to saturation.

Unfortunately—or, fortunately, from the viewpoint of additional information—this has occurred to me on several occasions, with results which will be given presently. When iron is submitted to severe magnetisation the result after removal of the magnetisation is to bring it back to the point B in Fig. 1. The differential permeability at B (the slope of the loop), with or without the valve polarising current, is less than that when B occurs near the origin O. Thus, due to polarisation, the inductance decreases, so also does the wavelength. The

<sup>2</sup> In the American transformer this change reduced the wavelength 6 per cent.

fall in inductance is, with any given valve, accompanied by a slightly sharper peak to the magnification curve and less magnification. This is illustrated by the curves of Fig. 12, in which is shown the same transformer after large polarisation and after treatment by A.C. at 300 cycles. When two or more transformers are used in cascade, and this ill-fortune of saturation befalls one of them, the optima wavelengths are no longer the same, the tuning is flatter—thus losing selectivity—and the magnification less. The problem now arises as to a remedy for the above effect. By passing an alternating current of, say, 300 cycles, whose R.M.S. value is equal to the short-circuit polarising D.C. from the H.F. tapping of the

battery =  $\frac{\text{volts}}{\text{resistance of sec.}}$ , and slowly reducing it to zero, a vast improvement can be effected, but the iron does not quite return to its normal state. A similar effect was noticed by Mr. E. C. Cork on an audio-frequency transformer of stallo stampings. The effect observed was, of course, a sub-normal primary inductance and a defective amplification-frequency curve.

Where A.C. is not available, reversals of gradually decreasing D.C. could be tried, but a simpler way is to treat all transformers alike, i.e., put the H.T. on them. The result is to give similar optima wavelengths, but less magnification. With a low-impedance valve there would not be much difference in the latter factor. Some approximate results bearing upon the above topic are set forth in Table VII.

TABLE VII.

ILLUSTRATING POLARISATION OF 1.5 MIL IRON AND SUBSEQUENT RECOVERY BY THE USE OF A GRADUALLY DECREASING MAGNETISATION AT 300 CYCLES.

Transformer No.	Optimum Wavelength (Metres).		
	Original.	After Polarisation.	After A.C. Treatment.
1	7,100	5,700	7,000
1	7,000	5,700	6,700 (second polarisation with inadequate treatment)
2	9,200	7,200	9,000

An inspection of Table VII will show that transformer No. 1 experienced rather bad luck and had to be treated twice. In the second case the maximum A.C. magnetisation was apparently insufficient to bring about normal restoration.

Transformer Design.

The constructional details of the transformers are shown in Figs. 2 and 3. The core consists of from 180 to 200 complete windows of 1.5 mil iron, these being cut to allow erection in the well-known manner. The overlap joints were of sufficient area to reduce the influence of the air gaps to a negligible value. The ebonite bobbins were grooved as shown in Fig. 3, and the primary arranged to slide within the secondary. This construction gave a fairly low self-capacity, but, owing to the closeness of the two windings and the ebonite dielectric between them, the mutual capacity was rather high. However, it appears to be possible by slight alterations in design to obviate this to an extent. For example, the windings could be staggered in addition to increased spacing between them, as shown in Fig. 3b. A transformer was constructed on these lines, and the effective primary capacity during operation was 12 per cent. less than the

**Supersonic Transformers, Part III.—**

other arrangement. The sides and tops of the stampings should be about half the width of the centre piece, so that the flux density is uniform. It was thought desirable, however, on account of the thinness of the iron, that constructional difficulties would be less by having the extra width. In any case, it does no harm, and probably reduces the leakage slightly.

Some calculations relating to the inductance may be of interest.

The inductance of the 300-turn primary winding without the iron is 1,220 microhenries. To get the inductance with the iron in place requires a little manipulation, but is quite easy if the flux through the air part of the cross-section of the primary is small compared with that through the iron. In our case the cross-section consists of 3.4 sq. cm. of air and insulation, and 1.0 sq. cm. of iron. The differential permeability of the iron can be assumed to be at least 200, so that the flux through the iron will be  $\frac{200}{3.4}$  times that through the air. Thus the influence of the air flux can be neglected. The familiar

formula  $L_1 = \frac{4\pi n^2 A \mu_d}{l} \times 10^{-3}$  microhenries will be used.

Since the area of each of the two side limbs is more than half that of the central limb, the flux density and the reluctance in the former will be reduced in a corresponding manner. Assuming linear relationships and constant permeability over the small range of flux density, the reduction in flux density (or the increase in area) is equivalent to a shorter length, as follows: Reluctance for

equal area is approximately proportional to  $l/A = \frac{15}{1.5} = 10$ . New reluctance is approximately proportional to  $\frac{5}{1.5} + \frac{10}{2} = 8.3$ . Hence the length is reduced in the ratio 8.3:10. It is, therefore,  $15 \times 0.83 = 12.5$  cm. Now  $\mu_d$  is unknown unless special permeability tests are made. Guided by results on audio-frequency transformers, the value of  $\mu_d$  was assumed as 300.

$$\text{Thus } L_1 = \frac{4\pi \times 300 \times 300 \times 1 \times 300 \times 10^{-3}}{12.5} = 27,000 \text{ microhenries.}$$

By measurement with the actual 3:1 transformer whose optimum wavelength bordered on 7,000 metres, the inductance was 24,000 microhenries, which shows a fair agreement. Since the primary winding alone has an inductance of only 1,220 microhenries, the effect of the iron is to increase this twentyfold. This figure is of a similar order in low-frequency inter-valve iron-cored transformers. Thus the effective permeability can be regarded as 20. Now with a little persuasion it might have been possible to increase the number of stampings in the core—the packing is not easy—by 25 per cent. The effective permeability would then have been 25. Care must be taken to avoid confusion between the differential permeability  $\mu_d$  and effective permeability  $\mu_e$ . The former depends entirely upon the iron in the magnetic circuit, whereas the latter depends upon the length and cross-sectional area of the winding in relation to the same quantities for the iron. In the above computation the assumed value of  $\mu_d$  was 300, whilst that found from

experiment on the transformer was  $\frac{300 \times 24,000}{27,000} = 270$ , a difference of 10 per cent.

TABLE VIII.  
SHOWING DIFFERENTIAL PERMEABILITY OF IRON.

Transformer.	$\mu_d$ .	$\lambda$ Opt. (Metres).	$f$ Opt. (Cycles).
1	270	7,000	$4.3 \times 10^4$
2	260	9,000	$3.35 \times 10^4$

The data given in Table VIII show that there is no profound difference between the values of  $\mu_d$  at 7,000 metres and at 9,000 metres. In fact, the value at the latter wavelength is 3 per cent. less than at the former. This is hardly in agreement with theory, since the deficit should be reversed, owing to the lower frequency. However, the incongruity can be explained as follows: (1) The values were obtained with two different transformers, and both cores had the misfortune to be saturated by the H.T. battery being short-circuited through the secondary winding. Although the transformers were treated with alternating current in the manner already described, the final state of the iron may have been different in the two cases. (2) There may have been slight differences in the assembly of the core stampings, e.g., joints, chipped enamel, etc. (3) Errors are likely to arise in the measurement of the effective primary capacity, and  $\mu_d$  is calculated from this value. The latter is the most probable source of discrepancy, for a small error in the measurement of the optimum wavelength implies a large error in the capacity of the transformer.

The values of  $\mu_d$  are probably sufficiently accurate for design purposes, so that it is easy to calculate the inductance of any particular transformer to a first approximation when its dimensions are available. Now it is also essential to know the optimum wavelength. Thus the effective primary capacity must be known, and here we enter the realm of uncertainty. Calculation of the capacity is generally inaccurate, and, therefore, it behoves us to resort to experiment. One might be tempted to compute the effective primary capacity from a knowledge of the self-capacities of the windings. This might work with some designs, but it leads to erroneous results in the transformers treated herein, as an example will clearly show. In transformer No. 1, having a 3:1 ratio, the self-capacity of each winding was 7 micro-microfarads. The effective primary capacity =  $7 + 3^2 \times 7 = 70$  micro-microfarads, whereas the measured value was 560 micro-microfarads. How can we account for this enormous difference? An inspection of Table VI will show that the mutual capacity is several times the self-capacity. Also it must be remembered that when the transformer is used in a valve circuit the windings are not entirely separated, and there is also the effect of  $V_2$ . These alter the potential distribution and also the capacity effect. Taking the experimental data, 560 micro-microfarads for a 3:1 and 1,000 micro-microfarads for a 4:1 transformer, and dividing each of these capacities by the square of the respective ratios, the result is the equivalent self-capacity of the secondary. The value in each case is 62 micro-microfarads, which indicates a modicum of consistency. This means that if the self-capacities of the windings and the mutual capacity were all zero, the effect of a



**Supersonic Transformers, Part III.—**

62-micro-microfarad condenser connected across the secondary would yield identical performance of this and the actual transformer.

Hence transformer design must be based upon a fairly accurate knowledge of the equivalent secondary capacity, and this can only be obtained from experimental work. Furthermore, it appears that improvements in the performance of the present transformers using 1.5 mil iron are to be sought in methods which reduce the effective primary capacity, chiefly that portion due to the mutual influence of the two windings. In the section devoted to the theoretical side of the subject, suggestions were proffered in the direction of increased inductance. The basis was constant turn ratio and constant optimum wavelength. There are, however, two cases of interest which will now be brought forward, in both of which the effective capacity is reduced. These necessitate either variation in ratio or wavelength or both. The first instance can be given from the experimental data. The primary windings of transformers 1 and 2 are identical, but the effective capacity of 1 is half that of 2. Hence with any given valve we should expect the top of the lower ratio transformer (3 : 1) to be flatter than the higher ratio (4 : 1). This is corroborated by the curves of Figs. 7, 8. For example, with a D.E.8 valve the breadth of the top when the amplification is 0.8 of the optimum is 12,700 cycles for the 3 : 1, as against 7,200 cycles for the 4 : 1.

The second instance is that where the primary turns are increased and the ratio decreased. The result is an increase in  $L_1$  and a decrease in  $C_s$  (unless an excess of turns is added). The effect will be to augment the breadth of the top of the amplification curve. The wavelength can be adjusted in the design, or a small capacity (not sufficient to defeat the object in view) can be added to the primary. As a case in point, suppose the primary turns on No. 2 transformer (4 : 1 ratio) are doubled. The ratio is now 2 : 1, the inductance is quadrupled, the effective resistance is quadrupled (leaving  $\frac{r_e}{L_1}$  the same as before), but the effective capacity is reduced to one-quarter its former value, assuming that there is no drastic change in the mutual capacity between the windings. Clearly the optimum wavelength is unaltered, whilst the factor  $\frac{C_s r_e}{L_1}$  is reduced to one-quarter its former value.

Hence the step will approach closely to the turns ratio. Furthermore, the top of the curve will be much flatter than before, and probably flat enough to enable a D.E.8 or a D.E.5B. valve to be used. With either of these valves the magnification would be 0.8 of that with the 4 : 1 transformer, so that the loss is not deadly, whilst there is a vast improvement in the flatness of the curve.

**Effective Resistance of Primary Winding.**

In a former section the part played by the effective resistance of the primary in reducing the step of the transformer was shown, particularly with valves of high internal resistance, although it also had the effect of flattening the top of the amplification curve. Here it is proposed to say a few words regarding the magnitude of the effective resistance.

By the aid of Fig. 18 and the data of Table VIII, it is possible to calculate the primary effective resistance to a first approximation. For transformer No. 2 the calculated value is 550 ohms. This is the value of the primary without the secondary in position. The influence of the latter will be to increase the resistance. From experiment the resistance of the primary with the secondary in position was 580 ohms at 9,000 metres, using a D.E.3 valve, so that there is a fair agreement.

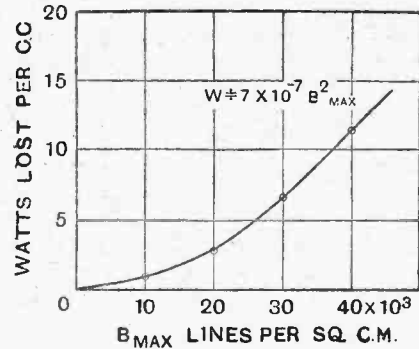

Fig. 18.—Curve showing loss in 1.5 mil iron sheet at 40,000 cycles per second.

The values of primary effective resistance have been determined experimentally from the various measurements of wavelength, capacity, magnification and valve coefficients. We have from previous formulæ the actual

$$\text{measured magnification, } M = \frac{Sm}{1 + \frac{\rho C_s r_e}{L_1}} \text{ Now all the}$$

quantities are known except the effective resistance. By measurements with different valves an average value of  $r_e$  may be found. It will be appreciated that slight discrepancies in the values of  $\rho$ ,  $C_s$ , and  $L_1$  will show up somewhat, so that the results cannot be regarded as more than first approximations. They have the advantage, however, of having been secured under working conditions. The results of the tests are given in Table IX.

TABLE IX.  
EFFECTIVE PRIMARY RESISTANCES OF TRANSFORMERS.

Transformer.	Primary (Ohms).		Optimum.	
	D.C. Resistance (Ohms).	Effective Resistance (Ohms).	$\lambda$ (Metres).	$f$ (Cycles).
1	50	850	7,000	$4.3 \times 10^4$
2	50	580	9,000	$3.35 \times 10^4$
American	82	7,000	Varies with valve.	

The first two parts of this article appeared in the issues of this journal for November 10th and 17th, and dealt with the general principles of iron-cored H.F. transformer design. Actual magnification curves, the result of measurements on a series of experimental transformers, were also given.

Part IV. will deal with the application of these transformers to superheterodyne circuits, and will include a concise summary of the principal factors governing supersonic transformer design and performance.



News from All Quarters: By Our Special Correspondent.

**Points about the Charter—A Geneva Triumph—Premature Reports—An Official Interrupter—  
Writtle Days Again—Unlucky Keston.**

**The Charter and the Board.**

There can hardly be any doubt that the Broadcasting Charter, the draft of which has received lively attention in Parliament and among listeners throughout the country, will be adopted as it stands. It will come into operation on January 1st. It is a very comprehensive document, and places tremendous powers into the hands of an untried Board of Governors, who, however, will have a guardian angel in the shape of H.M. Postmaster-General.

o o o o

**A Financial Improvement.**

The financial position of the Corporation should be more comfortable than that of the present B.B.C. The terms of the Charter provide for a definite increase in income according to the number of listeners, and this in itself promises an incentive towards the production of better and better programmes. In this connection Mr. Reith's appointment as director-general of programmes should ensure a progressive policy, but it remains to be seen what share will be taken in programme administration by the governors, the chairman of whom is to receive £3,000 per annum.

o o o o

**Collection of News.**

One of the most important provisions of the Charter, it seems to me, is the freedom granted to the Corporation for the collection of news. Hitherto the B.B.C. has been restricted to the ladling out of what amounts to a nightly "rehash" of the evening newspapers, very stimulating, no doubt, to residents in Muddleton-on-Mud, but sometimes a little boring to denizens of the towns. The Corporation will have power to collect news on its own account, so perhaps we may one day enjoy the pleasure of listening to a "red hot" news item which has even escaped the newspapers!

o o o o

**Avoiding Controversy.**

And yet . . . the Corporation must avoid controversial matters! Many people may agree to this clause in the Charter until one day the Corporation News Department finds itself precluded from giving news of, say, a "Round the World

Flight," through fear of upsetting the beliefs of the Flat Earth Sect. It seems unimaginable that broadcasting can continue many more years on the basis of a bovine neutrality on subjects like religion, politics, and so many other things that add a sparkle to this drab life of ours.

o o o o

**To-morrow's National Concert.**

The fourth of the B.B.C. Albert Hall concerts, which takes place to-morrow evening (Thursday), will be conducted by Sir Edward Elgar, who will have the national orchestra of 150 players. The solo violinist is Mr. Albert Sammons. The programme will be as follows: Concert Overture, "Cockaigne" ("In London Town"); Concerto for Violin and Orchestra; "Falstaff" (symphonic study for full orchestra); Introduction and Allegro for Solo Quartet and Stringed Orchestra, and Triumphal March from "Caractacus."

**Bravo, Geneva!**

Congratulations are due from all listeners to the Bureau Internationale at Geneva for coming nearer to a solution of the European interference problem than ever before. On the whole, the scheme is giving satisfaction. As I ventured to predict, a certain amount of trouble was experienced in the early stages, but every day now sees an improvement. The first few evenings revealed heterodyning between Leipzig and London; Manchester, Newcastle, and Münster; Cardiff and Seville; while reports indicated less satisfactory reception of Bournemouth, Glasgow, and Belfast.

o o o o

**London and Leipzig.**

The most serious case of heterodyning was that affecting London and Leipzig, which was probably due to the fact that almost at the last moment Geneva reversed

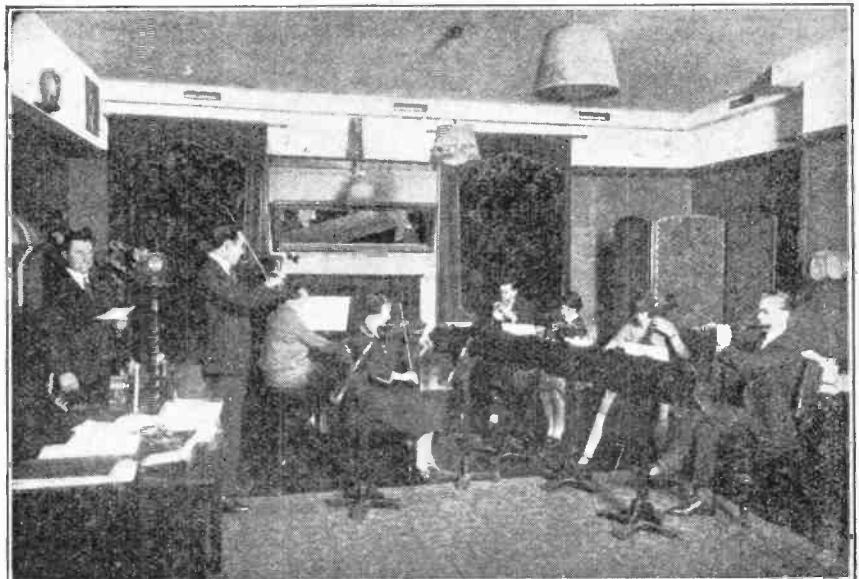

**BROADCASTING—AUSTRALIAN STYLE.** To those accustomed to the almost oppressive air of sanctity in British broadcasting studios this photograph taken in the 3LO studio, Melbourne, may come as a mild shock. The general atmosphere of informality is heightened by the presence of the office desk and the absence of draping.

the position in the wave scale of Leipzig and Breslau, putting Leipzig on 367 metres and Breslau on 322.6. But Leipzig, instead of remaining on 367 metres, began wobbling about in the neighbourhood of 359 metres, a separation of only 2½ metres from 2LO. Leipzig, of course, uses a power three times as great as London, and the interference was hardly surprising.

#### A Threatened Deadlock.

At first the German station maintained that it was on its correct wavelength, and, as London did the same, something like an *impasse* was threatened. The question was even raised of sending the wavemeters of both stations to Brussels for retesting. It is significant, however, that the heterodyne trouble has now ceased!

The technical committee of the *Unioné Internationale* at Brussels, under M. Brillaud, is the ruling authority in questions of this kind, and it seems very likely that the committee may have a busy time ahead.

#### Premature Reports.

Although the B.B.C. is not encouraging reports from ordinary listeners on the subject of the Geneva wavelengths until the end of this week, a good many have been received. These have been filed away and will be collated with the mass of reports expected from all parts of the country next week.

#### Critical and Otherwise.

When I was given an opportunity of inspecting these premature epistles, I found that in point of number they were fairly evenly divided between the critical and the congratulatory. A striking feature was the absence of criticism from listeners who had hitherto relied on a relay station. Perhaps this is because they are finding that, outside the 5-mile radius, the main stations are emerging much more clearly than before the Geneva scheme came into being. Again, it may be due to the apparent increase in the power of Daventry.

#### Daventry.

The strength of 5XX during the last week has been really surprising and has naturally given rise to the belief that the power had been increased. An official of the B.B.C. assures me, however, that no increase has been made, but that the better results are entirely due to improvement in the modulation system.

Is 5XX over-modulating?

#### Order! Order!

After what happened last week, only a really scurvy knave would deny the B.B.C. a sense of humour. During the debate between Prof. Julian Huxley and Mr. Cecil Lewis, a member of the studio audience, apparently taking exception to one of the sentiments expressed, suddenly exclaimed, "It is disgraceful! It ought not to be allowed!" The beauty of the incident lies, of course, in the fact that the "interruption" had been rehearsed and was intended to "heighten the effect."

#### FUTURE FEATURES.

##### Sunday, November 28th.

LONDON.—Light Symphony Concert, Niedzielski (solo piano).

BOURNEMOUTH.—Song Cycle, "In a Persian Garden."

CARDIFF.—Elgar's "Dream of Gerontius."

ABERDEEN.—Concert relayed from the Cowdray Hall.

##### Monday, November 29th.

LONDON.—"My Programme," by a Wireless Pioneer.

GLASGOW.—Rubenstein Programme.

ABERDEEN.—"Landing the Shark," by Vivian Tidmarsh.

BELFAST.—"Bangor" Programme.

##### Tuesday, November 30th.

LONDON.—Military Band Programme.

BOURNEMOUTH.—"Dick's Sister," Duologue by Norinan McKinnel.

CARDIFF.—5WA visits Pontypridd.

MANCHESTER.—St. Andrew's Day Programme.

NEWCASTLE.—An Operatic Miscellany.

GLASGOW, ABERDEEN, BELFAST.—St. Andrew's Day Programme.

##### Wednesday, December 1st.

LONDON.—Felgate King's Revels of 1926.

BIRMINGHAM.—"In Sunny Naples."

BOURNEMOUTH.—"Carmen."

MANCHESTER.—"Holed Out in One," by Claude Radcliffe.

GLASGOW.—Scottish Town Series—Falkirk.

ABERDEEN.—Old Favourites.

##### Thursday, December 2nd.

LONDON.—Handel's Serenata, "Acis and Galatea."

CARDIFF.—"Viewpoints." Radio Play by M. Tydfil Richards.

NEWCASTLE.—"Pelleas and Melisande," by Maurice Maeterlinck.

GLASGOW.—Orchestral Concert relayed from St. Andrew's Hall.

BELFAST.—"The Ulster Ceilidh" (Grandma's Birthday), by Charles K. Ayre.

##### Friday, December 3rd.

LONDON.—R.L.S. Programme.

BIRMINGHAM.—"A Sharp Attack," by Herbert C. Sargent.

GLASGOW.—Scottish Verse Speaking Recital (Elizabethan).

ABERDEEN.—The Dominie's Concert Party.

##### Saturday, December 4th.

LONDON.—"How's That?"—a new Radio Review, book by Cecil Lewis.

NEWCASTLE.—"The Brigands," Opera Bouffe by Offenbach.

ABERDEEN.—"A Romance of Spain," Concert Opera written by Norman Ingram.

#### An Official Interrupter?

I am entirely in favour of the interruption method of heightening effect, and would commend the idea to the Corporation. Why not appoint a Director of Interruptions? His job would be clearly defined.

ANNOUNCER: A heavy depression over Iceland is travelling towards this country—

OFFICIAL INTERRUPTER: It is disgraceful! It ought not to be allowed!

The Official Interrupter could serve a valuable purpose by mollifying listeners who do not appreciate any particular item. He could interrupt every item with a formal protest on behalf of those listeners who are not satisfied. Such a scheme ought to please everybody.

#### Reminder of Whittle Days.

The informal birthday programme given by members of the B.B.C. staff under the direction of Capt. Eekersley on Saturday, November 13th, must have taken many of us back to the old Whittle days, when Capt. Eekersley used to conduct the same type of performance from 2MT to the delight of the (comparatively) few listeners of that day. The birthday concert showed that the pioneers have nothing to learn from present-day exponents of the art of addressing the microphone.

#### More Relays from America?

If conditions are favourable, we may hope for some more American relays as excellent as that carried out on November 13th. On this night the G.E.C. at Schenectady was using two wavelengths, viz., 32.79 from 2XAF, and 26.8 metres from 2XAD; the relay was carried out on the higher wavelength. During the last three months I understand the engineers at Keston have been carrying out some exhaustive tests with short waves from Schenectady. It is noteworthy that the relay on November 13th was the earliest yet attempted, as it took place at 8.55 p.m. G.M.T.

#### Unlucky Keston.

As a matter of fact, the engineers at Keston have been singularly unlucky in arranging relay transmissions of this type. Atmospheric conditions can never be foretold with any exactitude, and so it comes about that America is often picked up perfectly at times when the ordinary B.B.C. programmes cannot possibly be interrupted. And yet, as we found last winter, if a definite programme period is granted for the purposes of a relay, the odds are that atmospheric conditions are too atrocious to describe!

#### Paying Performers by Advertisement.

Mr. Angus McHaggis, of Aberdeen, challenging the B.B.C. idea of "paying performers by advertisement," asks whether such a scheme is consistent with the regulation forbidding broadcast advertisement of any description. Mr. McHaggis should refrain from asking awkward questions.

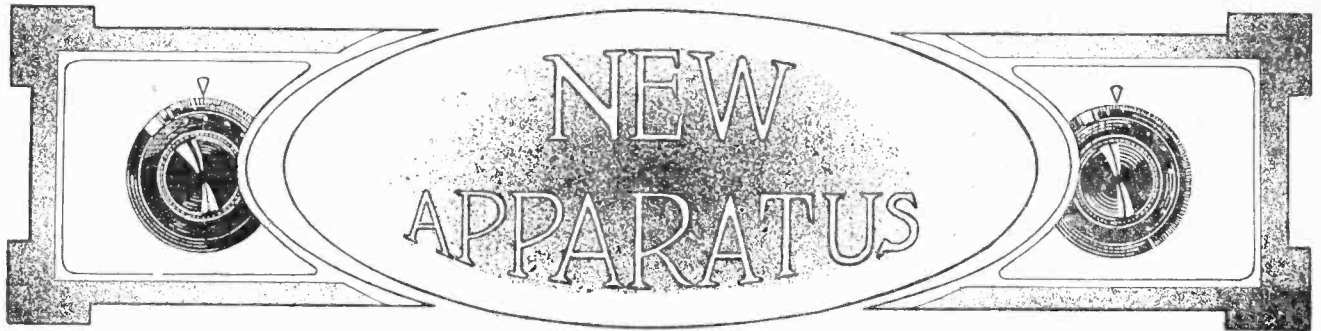

# NEW APPARATUS

## A Review of the Latest Products of the Market.

### "LIBERTY" SUPERSONIC UNITS.

THE supersonic heterodyne receiver shares with the multi-staged neutrodyne the distinction of being the finest type of long-range broadcast receiver that has yet been produced. But whereas the neutrodyne requires considerable skill in construction, the "superhet" can be built by a novice with every chance of success, *provided* that he makes use of accurately matched transformers for the intermediate amplifier. Failure to adjust the intermediate amplifiers to the same wavelength is the most frequent cause of failure of home-constructed superheterodynes, but given a properly calibrated coupling unit for the intermediate amplifying valves, there is no reason why the beginner should not be able to build for himself a reliable long range receiver working off a frame aerial.

To help the home constructor over the initial difficulty the Radi-Arc Electrical Co., Ltd., Bennett Street, Chiswick, London, W.4, have produced a supersonic coupling unit in which the transformers are accurately matched for wavelength. The transformer windings are supported on ebonite spools turned from solid ebonite rod to fine limits on a capstan lathe. Each transformer is wound with exactly the same number of turns, but this does not necessarily give the same natural wavelength in each case,

due to variations in the self-capacity. Accordingly each transformer is tested by inducing currents in the secondary from a calibrated oscillator and measuring the current at resonance. By grouping transformers of similar characteristics in this way uniform and progressive amplification through the intermediate amplifier is assured.

In a lesser degree the oscillator windings may present some difficulty, and the manufacturers have therefore included special oscillator units for long and short wavelengths. The supersonic unit, together with the oscillator coils, is supplied with pictorial wiring and circuit diagrams, and a list of recommended valves and components.

We have seen the testing of these units, which is carried out with the utmost care, first of all electrically before assembling, and finally on broadcasting; and the makers' claims of range and selectivity are in no way exaggerated.

### CABINETS FOR HOME CONSTRUCTORS.

Although the use of planed boards has greatly facilitated the making up of cabinets, Messrs. Hobbies, Ltd., of Dereham, Norfolk, are now marketing pieces of wood already squared and to size, so that it is only necessary to screw and glue them together. The necessary pieces, which are accurately cut to dimensions, are sup-

plied in parcels for making up cabinets to various dimensions, and the principal advantage gained is that the amateur, in putting the cabinet together, can easily make minor modifications; while the finish, both by way of the addition of decorative mouldings and the colour to which the cabinet is polished, can be carried out to suit the user's particular taste.

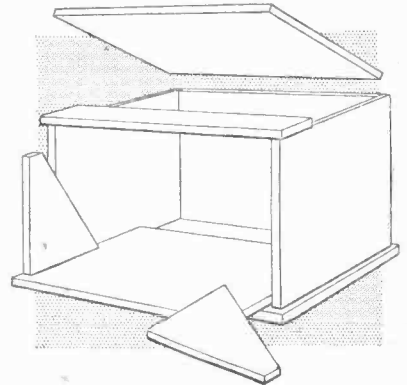

Hobbies cabinets are now obtainable in the form of finished pieces of wood ready for securing together and polishing.

The parcels of wood are inexpensive, and the amateur is provided with the necessary materials for making up a cabinet in a form in which he will not meet with any great difficulty, neither will he be deprived of the pleasure of constructing a cabinet to fulfil his requirements.

### Catalogues Received.

Eric J. Lever, 33, Clerkenwell Green, London, E.C.1. Catalogue for season 1926-1927 of Trix Wireless Components and Accessories. ○○○○

Oldham and Son, Ltd., Denton, Manchester. Illustrated leaflet describing and illustrating the range of Oldham high and low tension accumulators for wireless purposes. ○○○○

Siemens Brothers and Co., Ltd., Woolwich, London, S.E.18. Art catalogue (pamphlet 190A) dealing with Siemens Ebonite and containing information on the origin, properties and machining of ebonite.

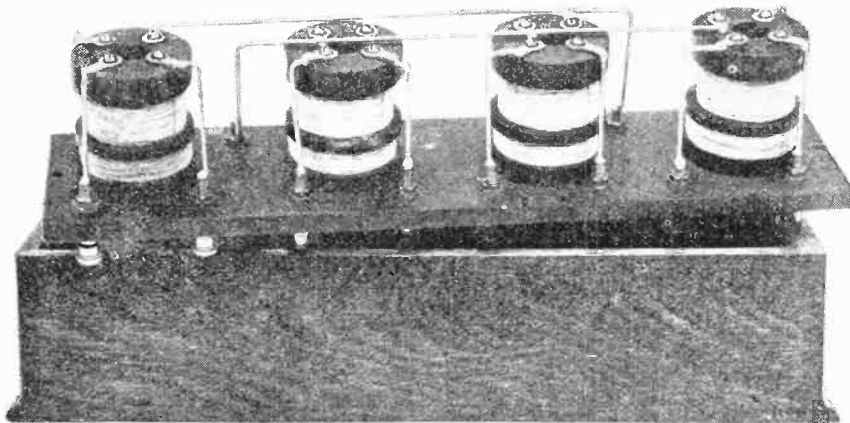

The "Liberty" interstage couplings assembled as a single unit simplify the construction of a superheterodyne receiver.



# Readers' Problems

"The Wireless World" Information Department Conducts a Free Service of Replies to Readers' Queries. Questions should be concisely worded, and headed "Information Department." Each separate question must be accompanied by a stamped addressed envelope for postal reply.

## Current-carrying Capacity of Anode Resistances.

*What was the reason for using two 1 megohm resistances in parallel in the anode circuit of the "Everyman's Four" receiver. Would not one resistance of 500,000 ohms valve have served equally as well? D.C.M.*

For technical reasons stated in the original article dealing with this receiver, it was necessary that the value of the anode resistance in the plate circuit of the detector valve be approximately 500,000 ohms. It was impossible to obtain a wire-wound resistance of this large value, and to connect five 100,000 ohms resistances in series would have been needlessly expensive, and cumbersome. In any case, it is obvious that owing to the high value of this resistance, the plate current would be limited to a few microamperes, and so wire-wound resistances would not be necessary. Although the plate current was so small, it was not deemed expedient to pass the whole of the plate current through a resistance of a type other than the wire-wound in case of crackling noises developing. It was decided, therefore, to divide the current through two paralleled resistances. Naturally, in order to maintain the value of 500,000 ohms, it was necessary that each of the two paralleled resistances should be of twice this resistance. The result was a compact unit which was equally effective and much cheaper and less cumbersome than a combination of wire-wound resistance of lower resistance value connected in series.

o o o o

## A New Use for a Tea Tray.

*Owing to my living in a flat I am prevented from putting up an outdoor aerial. I have experimented both with indoor aerials and with the use of the electric light mains as an aerial, but results have not been good. I have been told that by using the telephone wiring as an aerial I can get very good results, greatly surpassing those given by an indoor aerial. Is this so, and, if so, how can I make connection to the telephone wiring? R.K.S.*

In the majority of cases, it will usually be found that the results obtained when using the telephone wiring as an aerial far exceed those obtained by using the electric light mains for a similar purpose, and in many cases, results exceed those

obtained by a good indoor aerial. The method of setting to work is to obtain a small tray which must be of metal and not of wood. A terminal should be attached to this tray by drilling a hole in it, and to this terminal must be attached the wire running to the aerial terminal of the receiver. Alternatively, a wire may be soldered directly on to the tray. The tray should be placed upon a table, and the telephone placed upon the tray in accordance with the sketch given in Fig. 2. Connection will now be automatically made to the telephone wiring by virtue of the capacity existing between the metal tray and the internal wiring of the telephone which is resting on the tray. Usually the

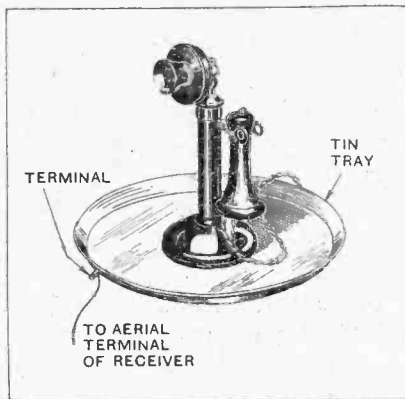

Fig. 2.—"Tea tray and telephone" aerial.

tray may be placed directly upon the table without being stood on insulators, although sometimes it is an advantage to place a small mat underneath the tray. In America, where this system is very extensively used, special small ornamental trays already fitted with a terminal may be purchased.

o o o o

## Reinartz Unravelled.

*In glancing through the pages of various technical publications, it would seem that there are an enormous number of ways of applying reaction. Can you tell me actually how many methods there actually are, and in what manner they differ from each other? P.M.O.*

Actually, of course, there are only two methods of applying reaction, namely, magnetically and capacitatively, and

nearly all the many reaction circuit variations in existence consist merely of alternative methods of controlling the degree of magnetic reaction, the actual method of applying reaction being the same in each case, namely, by means of a reaction coil placed in magnetic relationship with some other coil forming part of one of the tuned circuits of the receiver.

Many people realise the above points, but fall into the common error of imagining that circuits of the Reinartz type are capacity reaction circuits. Actually, of course, the Reinartz is not a capacity reaction circuit at all, because a capacity reaction is one in which the necessary feed-back of energy takes place capacitatively. In the Reinartz it does not take place capacitatively at all, but magnetically, through the juxtaposition of two windings, the variable reaction condenser being solely for the purpose of controlling the amount of H.F. current flowing through the reaction coil. Indeed, the only difference between the ordinary "swinging coil" method of reaction and the "Reinartz" method is a difference in the method of controlling the degree of energy fed back, the actual method of feed-back being magnetic in each case.

In the "swinging coil" method the value of the H.F. current flowing through the reaction coil is always at maximum according to the valve and external circuit characteristics, and is not under control. The amount of feed-back is effected by moving the reaction coil nearer to or farther from the grid coil in the receiver. In the "Reinartz" system the position of the coil is fixed, and the amount of H.F. current flowing through the coil, and, therefore, the amount of energy fed back is controlled by the reaction condenser.

Probably the best instance of a pure capacity reaction circuit is the type in which the plate of the detector valve is tuned by a variometer or coil and condenser, the energy feed-back then taking place solely through the inter-electrode capacity of the valve. Often a circuit is seen in which a variable reaction condenser connects the plate of the detector valve to the aerial terminal of receiver, and this is often mistaken for a capacity reaction circuit. Closer examination frequently reveals, however, that it is merely a modified Reinartz circuit in which the aerial coil is being used also as a reaction coil.